

World's first fully wireless access control system

Spintly is an access control manufacturer providing wireless access control system on a cloud-based platform

Mobile based access control and visitor management

Eliminating wired infrastructure from the built world

Ideal for new builds and updating legacy infrastructure

Company Overview

Problems in Traditional Access Control Systems

Inefficient Access methods

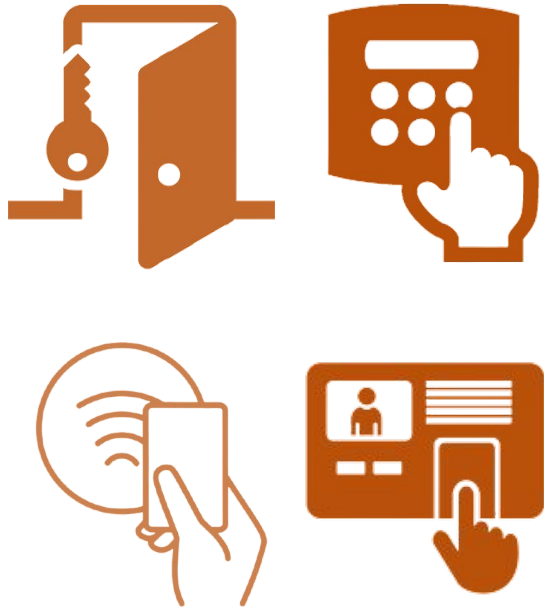

Local storage

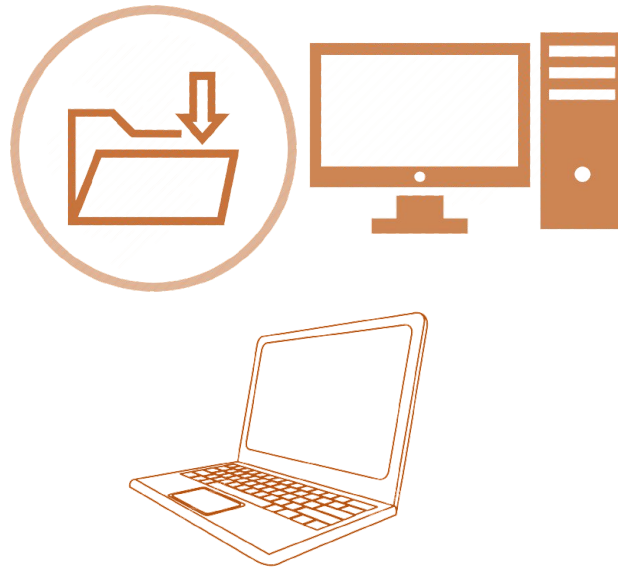

Excessive Cabling & hardware



With COVID-19 it is no longer safe to touch things around you

Spintly Contactless & Wireless access control

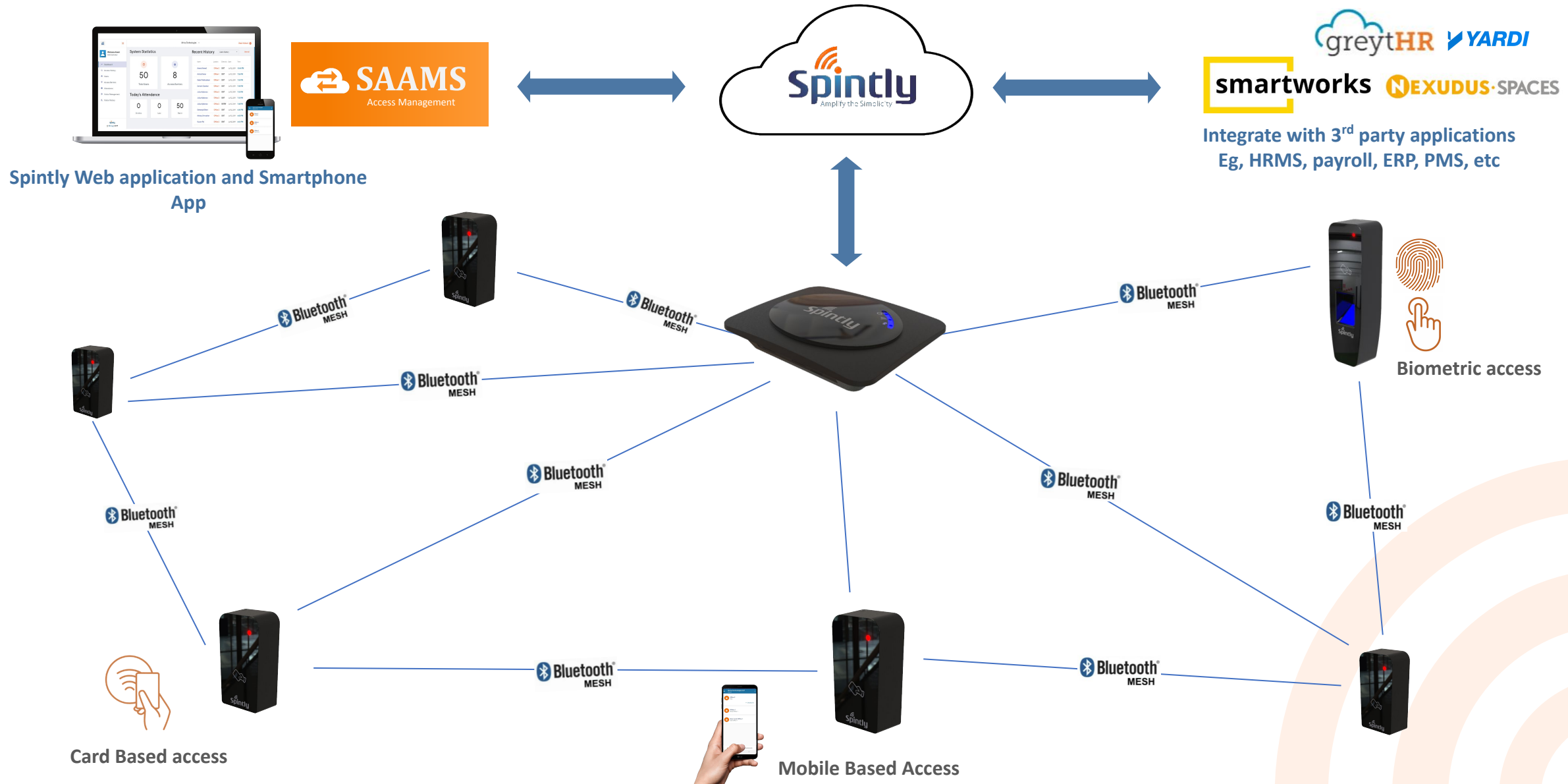

A Paradigm shift in Access Control

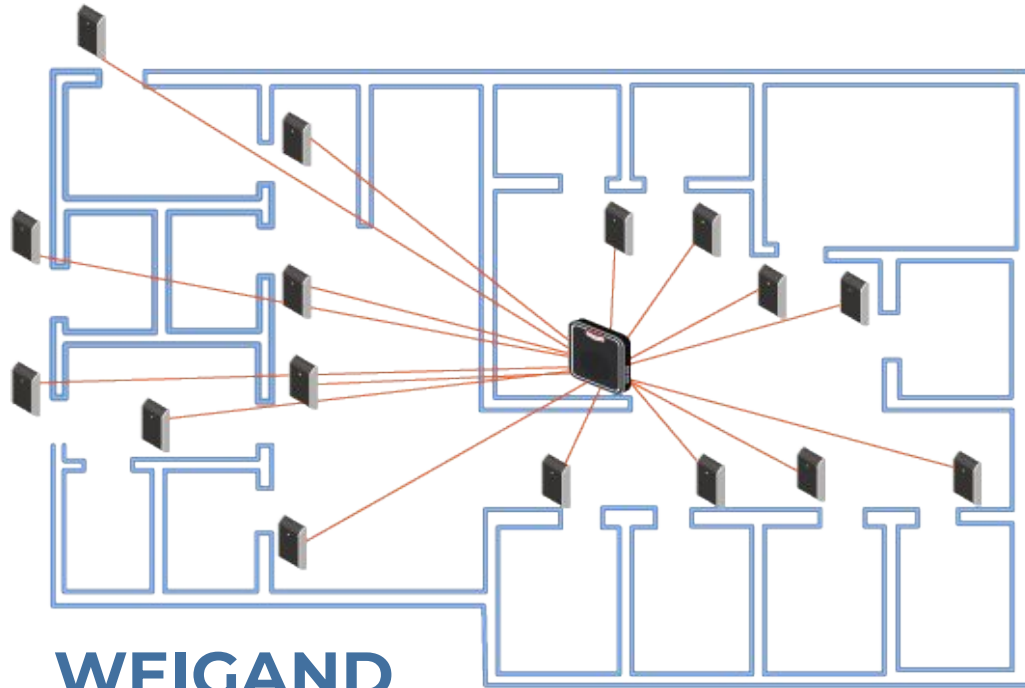

WEIGAND

Wired

- ❌ Excess wiring & labour intensive
- ❌ High installation cost
- ❌ Highly dependent on central controller
- ❌ Follows old security standards

Vs

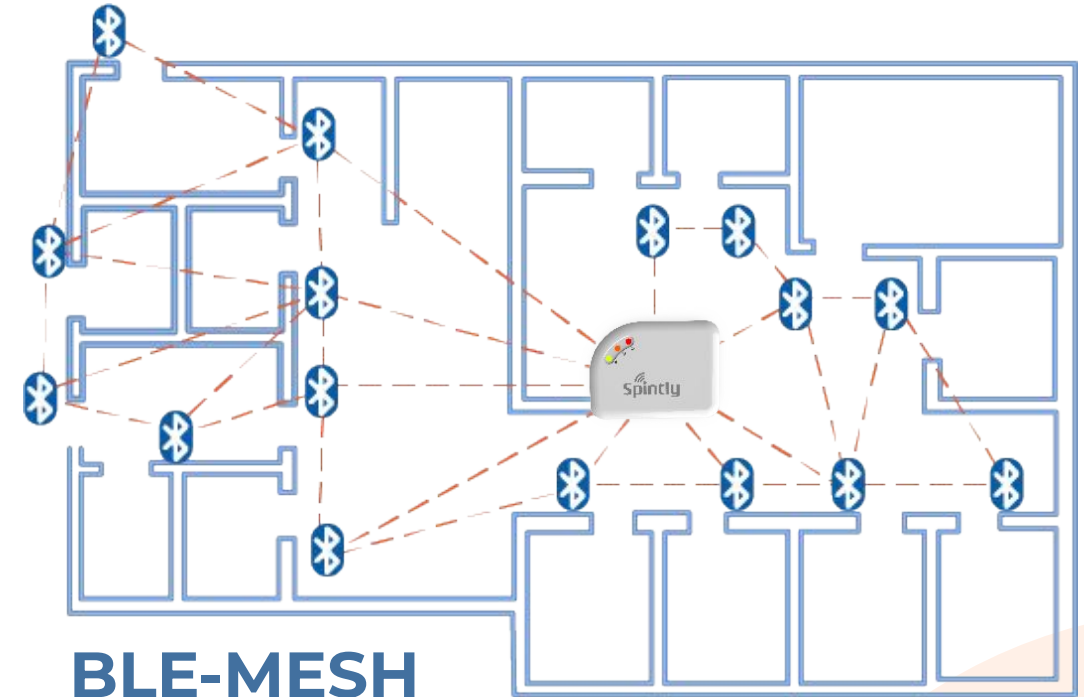

BLE-MESH

Wireless

- ✓ Minimum wiring for the door.
- ✓ Minimal installation cost
- ✓ Easy to install and retrofit
- ✓ Less dependent on central controller (gateway)
- ✓ Multiple levels of security & AES 128bit encryption

CONNECT YOUR PROPERTY TO THE CLOUD USING WIRELESS MESH



APIs, SDKs
Analytics &
Anomalies

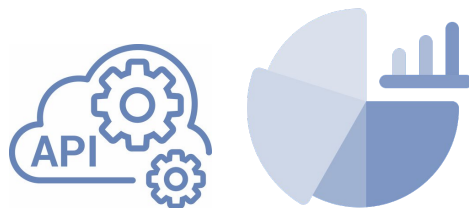

Single Pane of Glass



SECURING YOUR ACCESS IN YOUR DEVICES

Simplify & Secure Access Control

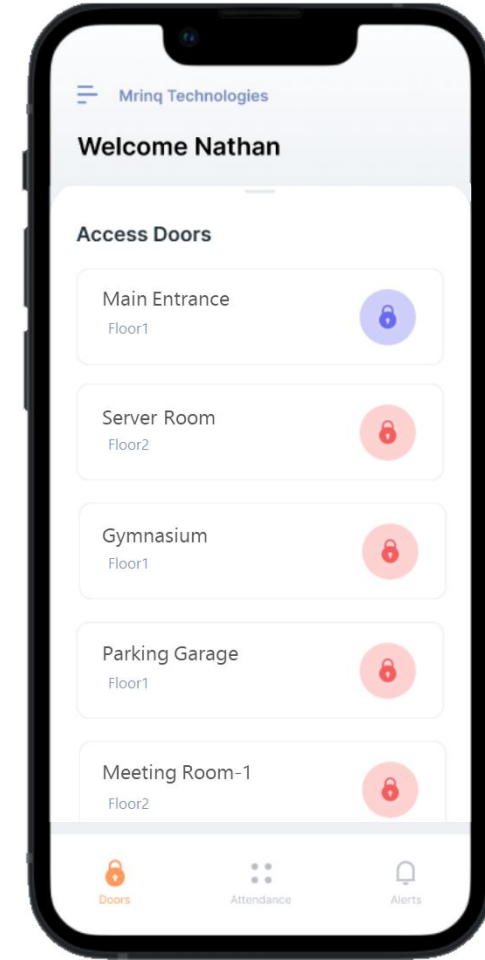
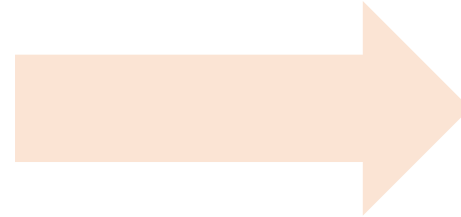

Move your access badges, Fobs and Keys into your smartphones and wearables

Seamless mobile access at every touch point

Access the main Door/ lobby

- Flap barrier access
- Turnstile access
- Swing door access



Office Access

- Office door access
- Meeting room access
- Cafeteria



Access the main Gate

- Boom barrier access
- Sliding gate access



Access to Elevators

- Contactless elevator access
- Floor based access

A Single App for all your access needs

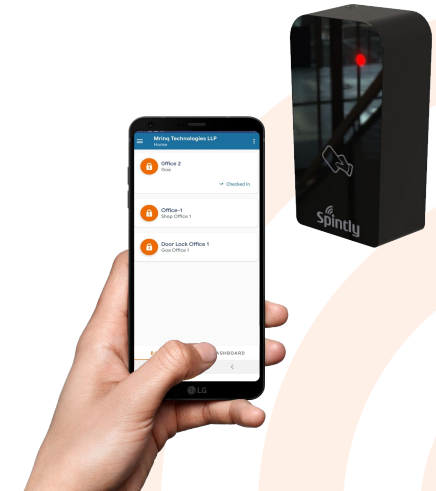

ACCESS CONTROL FOR COMMUNITIES

USE YOUR SMARTPHONE TO MOVE ACROSS YOUR COMMUNITY

- Smartphone based entry for common areas
- Digital intercom
- Single solution for all access points: Swimming Pool, Gym, Clubhouse access, gate, garage entry, lockers, apartment
- Remote opening by residents
- Visitor management and temporary access for visitors
- Retrofit existing system
- Cost effective and Convenient
- PMS and Camera Integration

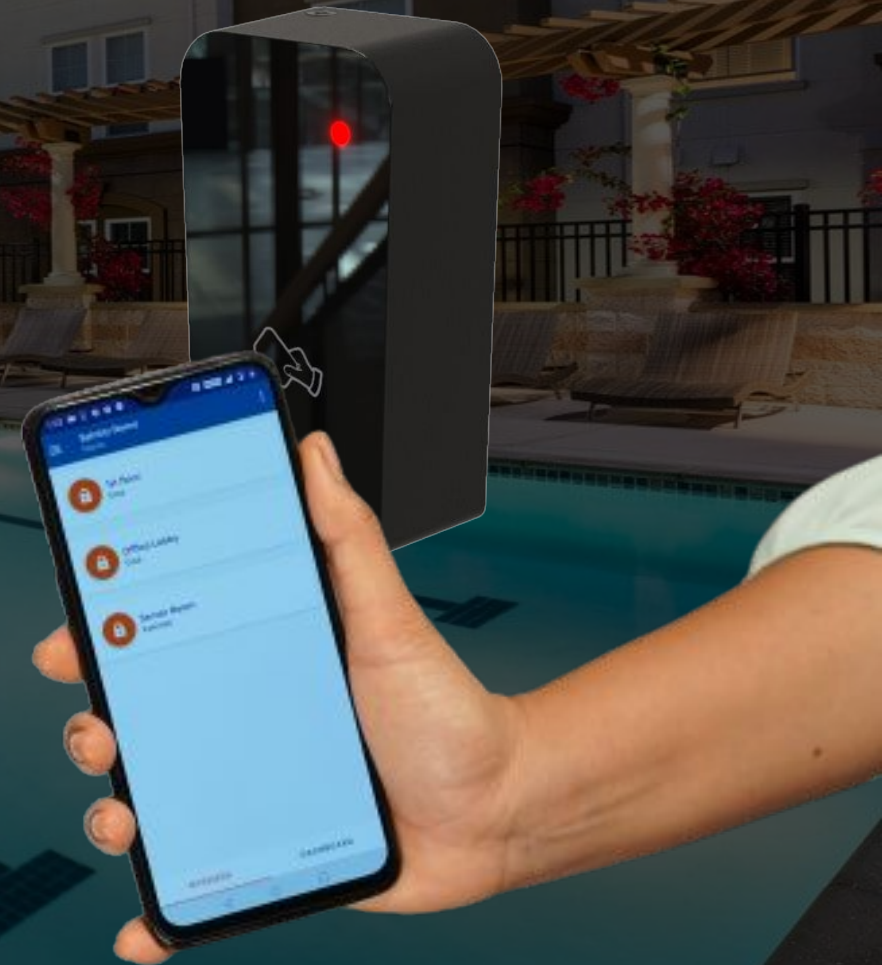

ACCESS CONTROL FOR ALL YOUR NEEDS INSIDE YOUR COMMUNITY



Gate access



Clubhouse access



Pool access



Gym access



Tennis court access

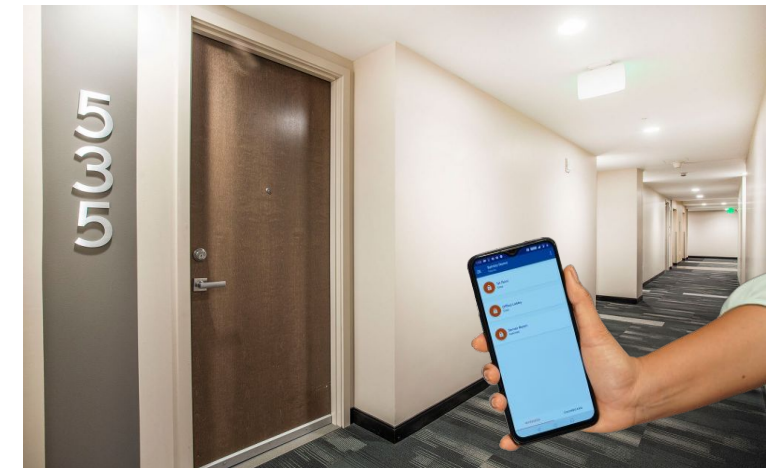

Apartment access

Seamless mobile access

Software Offerings



Access Management



Attendance Management



Contactless Visitor Management

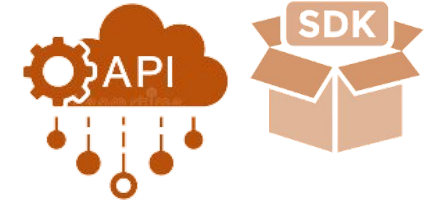

Integration

Hardware Offerings



Smart Access Uno



Fingerprint Access Control



Smart Stainless-Steel door lock



Smart Access Outdoor



Fi-B Gateway



Mesh Repeater

APARTMENT UNIT ACCESS

GET RID OF THE HASSLE OF
MANAGING PHYSICAL
KEYS FOR YOUR RESIDENTS
AND IMPROVE SECURITY
OF YOUR COMMUNITY



Smart Door Lock

Smart and convenient door lock system which unlocks your doors using smart phone, wearable devices and Mifare card.

Features:

- Smartphone based access using BLE (Bluetooth Low Energy) and NFC.
- Remote access through the cloud.
- Robust design.
- Long battery life.
- Easy to install and retrofit.

Modes of Access:



Spintly
Amplify the Simplicity



Model No.: PD-011

Manufactured by



Powered by Spintly

TYPICAL INSTALLATION

Simplify & Secure Access Control

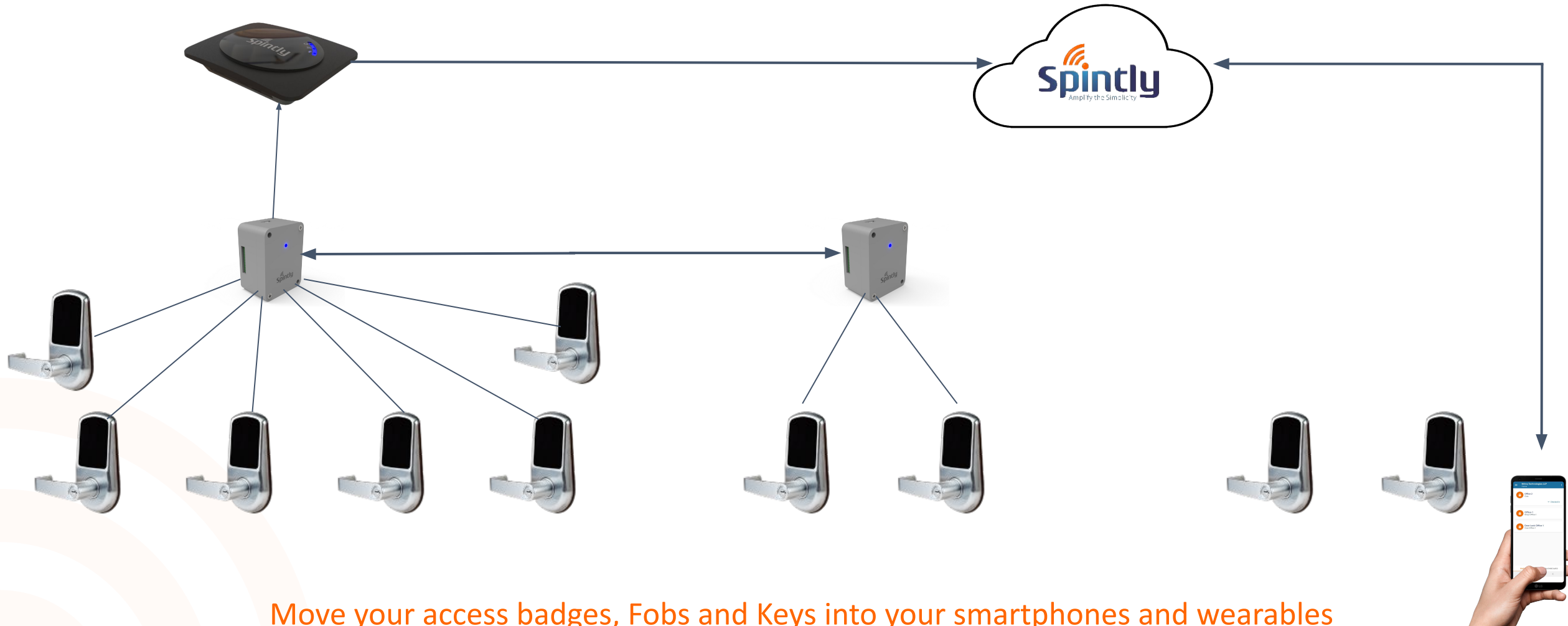

Move your access badges, Fobs and Keys into your smartphones and wearables

CLOUD BASED SOFTWARE FOR ACCESS MANAGEMENT

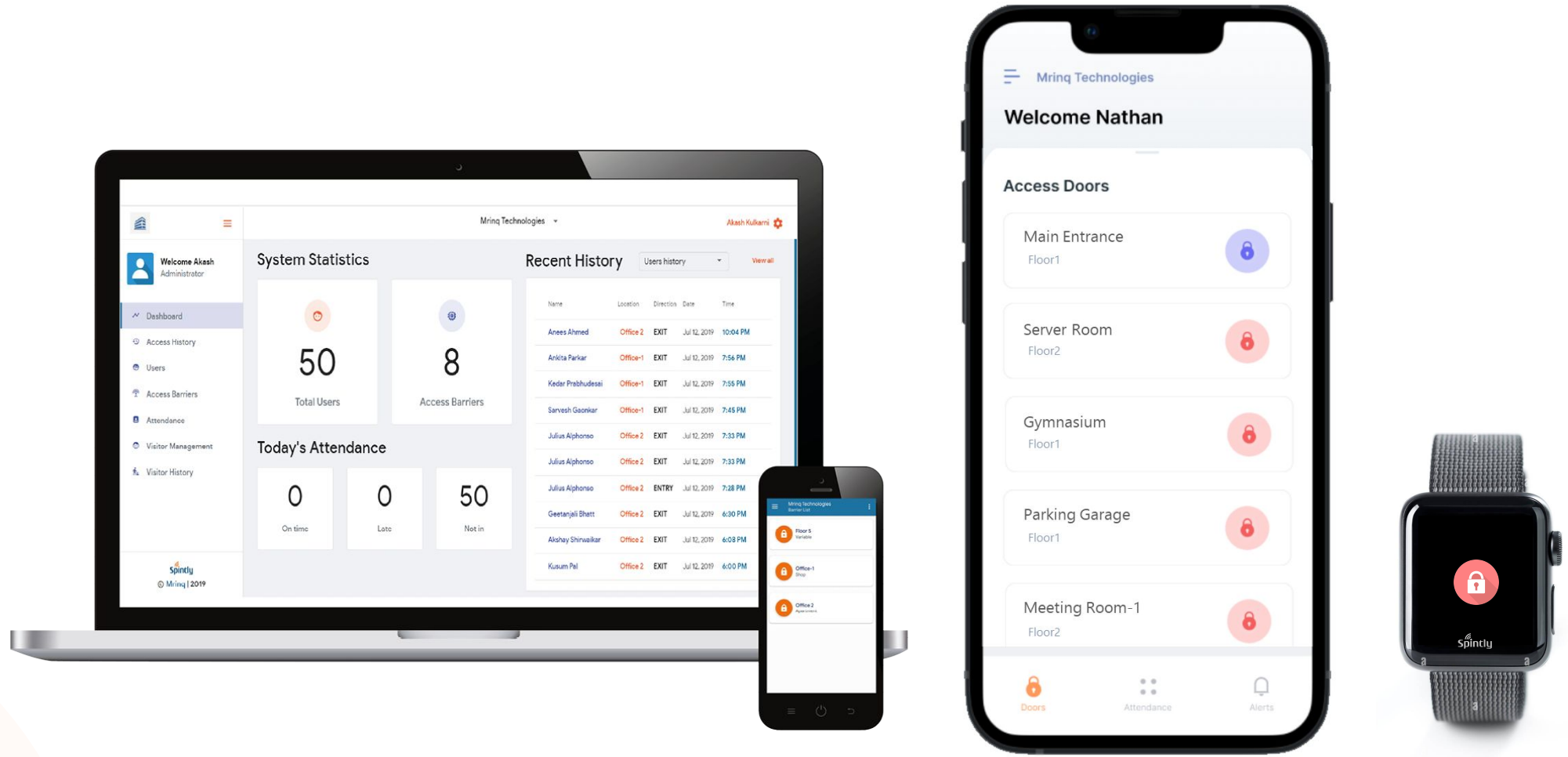

MANAGE YOUR COMMUNITY ACCESS WITH OUR POWERFUL SOFTWARE

Traditionally, a pen and paper-based attendance system were prevalent. It used to be time-consuming and is also subjected to human errors. It is a repetitive process and sometimes employees forget to check in and check out.

Spintly provides the most flexible, reliable and convenient Time and Attendance solution which allows employees to check-in with their favourite check-in method which include smartphones, access card or Biometric (Fingerprint and face recognition)

Attendance Reports
Generate real-time attendance reports and receive automated reports on e-mail or view the reports on the smartphone dashboard.

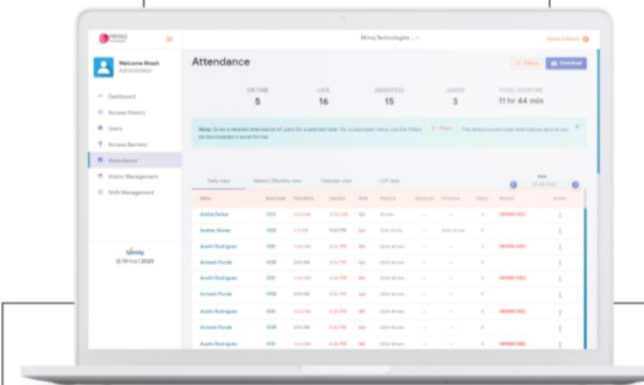

Leave Management
Employees can request their leaves through their app and managers can instantly approve the same on their smartphones.

Custom attributes
Create attributes relevant to your organization and generate custom reports as per your needs.

Shift Management
Create multiple shifts which can run in parallel and manage shifts using a shift roster with a user-friendly UI

BENEFITS OF CLOUD-BASED TIME & ATTENDANCE MANAGEMENT



Check-in through Phone

The cloud-based system allows you to check in and out with the help of your smartphone. You do not need to carry another ID card or a key card



Location Capture

While checking in through your smartphone, the app can also track your location and store it. The system administrator can locate you anytime with the information

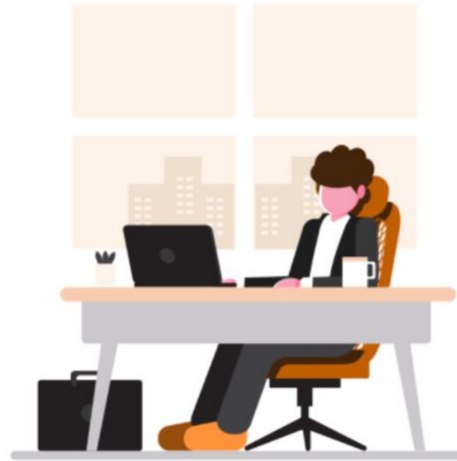

Payroll Integrations

Syncs attendance data with third party HRMS and Payroll software to streamline the payroll process



Leave and Absence Management

Employees can apply for the leave through the app and the request can be viewed by their managers instantly. Once approved it can instantly get filled in the timesheet

CONTACTLESS VISITOR MANAGEMENT



Scan QR-Code
To Check-in



QR Code for Check-in

Web based check-in

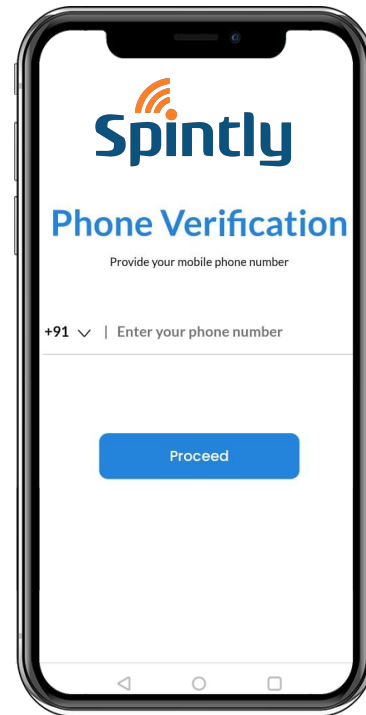

OTP based verification

Get approved by the host

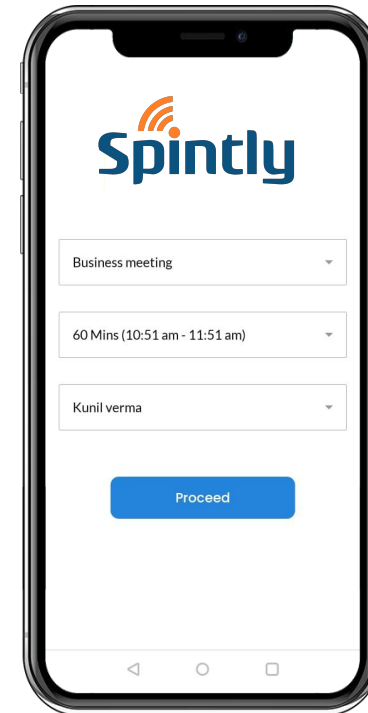

No App needed for
Door Access

CONTACTLESS VISITOR MANAGEMENT



CHOOSE INTERCOM OPTION WHICH BEST SUITS YOUR VISITOR MANAGEMENT NEED

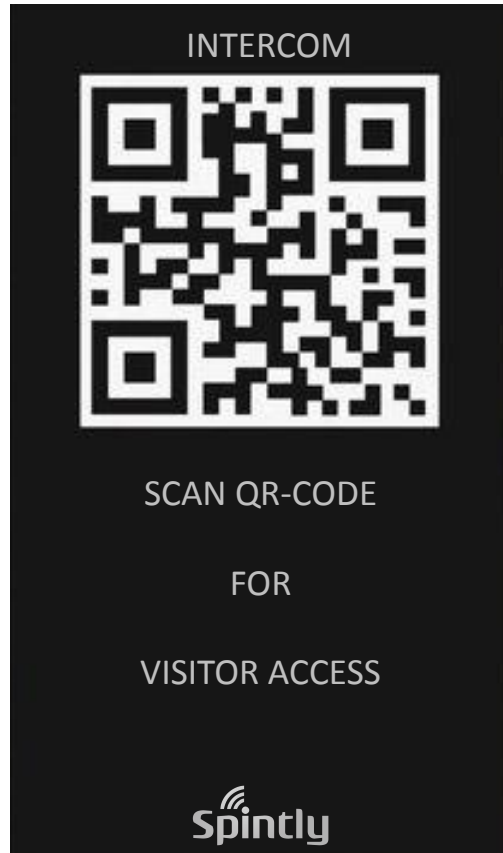

SOFT INTERCOM



VIDEO INTERCOM

Spintly – Market Segments

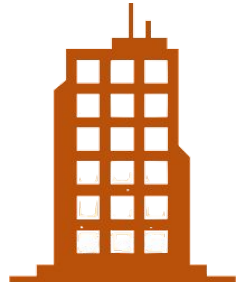

Corporate / IT-ITES

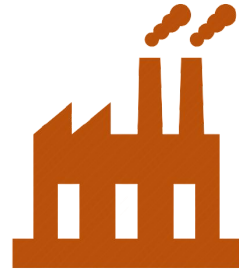

Manufacturing

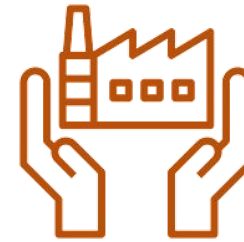

SMB



Shopping Mall



Co-Working



Co-Living

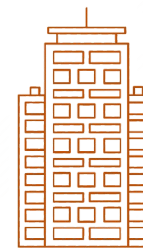

Residential



Hospitality



Healthcare



Government



Education



Sports Club

Customers & Partners



Thank You

Contact

Matthew Boglary

matthew.boglary@spintly.com

+1 310 596 9877



www.spintly.com

📍 Office Address:

C/o Mring Technologies
G1, Vaz Building, Fatorda,
Salcette, Goa 403602

📍 India Address: NLR Enclave, #15,

1st Cross Rd, Vinayaka Layout,
Bhoopasandra, R.M.V. 2nd Stage,
Bengaluru. Karnataka 560094

📍 USA Address: 20164 Pienza Ln,

Porter Ranch CA 91326
Los Angeles

✉️ sales@spintly.com

☎️ +91 8766812888