

# New Product Updates

Date: October 14<sup>th</sup>, 2024



## Electronic Spirit Hardware

A wide range of electronic door hardware powered by Spirit!

## PDQ Spirit App

An all new solution for bluetooth and Wi-Fi based access control! Pairs seamlessly with our Spirit line. View an activity log of use access and device status, add/manage multiple Spirit devices in one place, set your ideal locking mode, and more!

## 6GW Exit Device Trim

Wide Grip Pull Trim for the 6300 exit device. Available in 2 functions and 3 finishes.

## 4200 Commercial Exit Device

605, Polished Brass, finish removed from all exit devices and exit trim

## PL-1 Padlock

3 body sizes paired with a frangible or stainless steel shackle

# COMING SOON!



## California Building Code Compliant Exit Device

CBC Chapter 11B-309.4 established a 5 lb. maximum force on operational hardware, including panic hardware. Available on our Rim, Concealed Vertical Rod, and Surface Vertical Rod 6300/6400 platforms.

- Available with both top & bottom rod and LBR for surface and concealed vertical rods



# PRICE BOOK

EFFECTIVE JULY 3<sup>rd</sup>, 2023

SECURING  
CONFIDENCE.  
OPENING  
POSSIBILITIES.



# Customer Support

## Customer Support

Our Customer Support team is available to answer questions or provide any assistance you may need.

**717.656.4281, [help@pdqlocks.com](mailto:help@pdqlocks.com).**

Monday through Friday – 8am to 5pm EST.

## Placing Orders

To place orders, email:

**[orders@pdqlocks.com](mailto:orders@pdqlocks.com)**

## Product and Technical Support

**PDQ Mechanical:** 833.273.7832, [support@pdqlocks.com](mailto:support@pdqlocks.com)

## Quotation and Product Cross Reference

[quotes@pdqlocks.com](mailto:quotes@pdqlocks.com), 717.656.4281

## Value Engineering Services (Complimentary)

[quotes@pdqlocks.com](mailto:quotes@pdqlocks.com), 717.656.4281

## Specification Writing Services (Complimentary)

[quotes@pdqlocks.com](mailto:quotes@pdqlocks.com), 717.656.4281

## World Headquarters Administrative Office U.S. Manufacturing Center

PDQ Manufacturing  
2230 Embassy Drive  
Lancaster, PA 17603 USA

## Remittances

PDQ Manufacturing  
P.O. Box 6426  
Lancaster, PA 17607 USA

## Regional Distribution Centers

Lancaster, PA, Norcross, GA, Auburn, WA

## International Sales and Distribution Centers

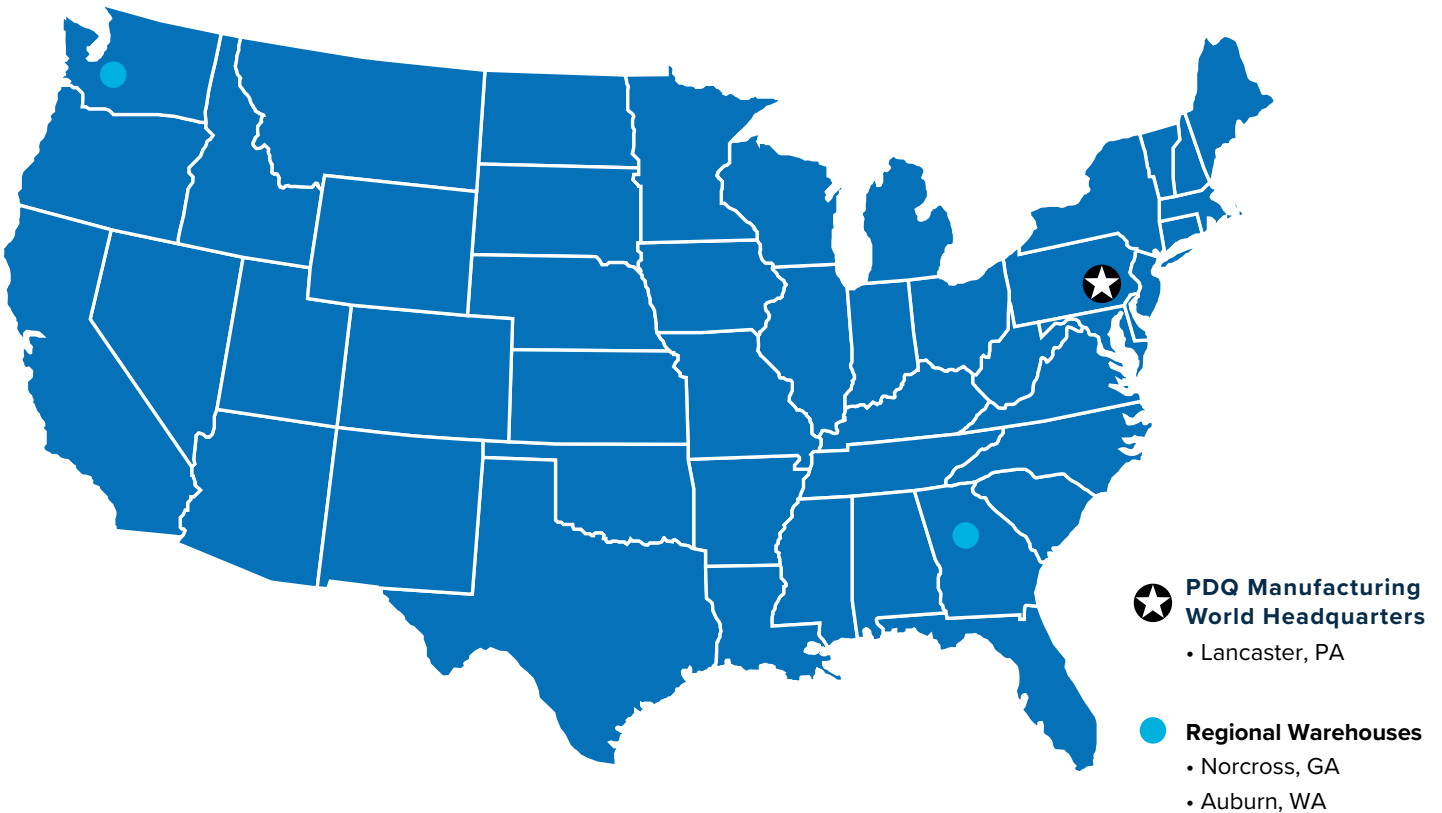

Abu Dhabi, United Arab Emirates



# Table of Contents

Common Pricing Information	6	<b>Door Closers</b>	<b>188</b>
Terms & Conditions	7	7100 Series Grade 1 Closer	189
Warranty	8	5100 Series Grade 1 Closer	195
<b>Mortise Locks</b>	<b>9</b>	5300/5500 Series Grade 1 Closer	201
MR Series Grade 1 Mortise	9	3100 Series Grade 1 Closer	208
TJ Tubular Trim Suite	31	SCS Spring Cushion Stop	216
<b>Cylindrical Locks Grade 1</b>	<b>35</b>	<b>Electronic Solutions</b>	<b>217</b>
XGT/GT199A Series Grade 1 Electrified Cylindrical	36	KMS-Spirit Series	218
XGT/GT135LED Classroom Intruder	37	CLS-Spirit Series	220
XGT Series Grade 1 Cylindrical	38	SDS-Spirit Series	222
GT Series Grade 1 Cylindrical	48	GTS-Spirit Series	224
SX Series Grade 1 Ball Knob	59	MRS-Spirit Series	226
<b>Cylindrical Locks Grade 2</b>	<b>65</b>	6EWS-Spirit Series	228
GP Series Grade 2 Cylindrical	66	Spirit Credentials	230
SD Series Grade 2 Cylindrical	74	Spirit App	231
SF Series Grade 2 Cylindrical	82	SDE Push Button Lock	232
CL Series Inter-Connected Grade 2	87	<b>Electrified Solutions</b>	<b>233</b>
SV Series Grade 2 Ball Knob	94	Electric Strikes	235
<b>Deadbolts</b>	<b>100</b>	Wire Harness	236
KM Series Heavy Duty Bored Deadbolt — Rim Cylinder	101	EPT100 ISMC Power Transfer	237
KT Series Heavy Duty Bored Deadbolt — Mortise Cylinder	106	Key Switches and Push Buttons	238
KV Series Commercial Duty Bored Deadbolt — Rim Cylinder	110	Power Supplies	239
MJ Mortise Cylinder Deadbolt	113	<b>Hinges</b>	<b>240</b>
<b>Padlocks, Euro Profile</b>	<b>115</b>	Commercial Hinges	241
PL Series Padlock	115	Electrified Hinges	246
EPIC Series European Profile Interchangeable Core	117	<b>Flat Goods</b>	<b>247</b>
<b>Cylinders, Keying Systems and Keys</b>	<b>119</b>	Flush and Surface Bolts	249
High Security Cylinders & Cores	120	Coordinators	252
Cylinders	121	Push Plates	255
Interchangeable Cores, Housings, Cams	125	Pulls and Pull Plates	257
Keys & Keying Systems	127	Push and Push-Pull Bars	264
<b>Exit Devices</b>	<b>130</b>	Fasteners	266
6300/6400R Rim	132	Door Protection Plates	267
6300/6400V Surface Vertical Rod	135	<b>General Hardware</b>	<b>269</b>
6300/6400C Concealed Vertical Rod	139	<b>Sliding Barn Door Hardware</b>	<b>273</b>
6300M Mortise	143	<b>Key Systems and Keying Forms</b>	<b>275</b>
6300D Dummy	146	<b>Customer Training Program</b>	<b>282</b>
6300/6400 Parts	153		
6300/6400 Trim	158		
<b>9300 Mullions</b>	<b>174</b>		
<b>4200 Commercial Exit Device</b>	<b>177</b>		
4200R Rim	179		
4200V Surface Vertical Rod	180		
4200 Trim	181		

# Common Pricing Information

1.	Locks are furnished with standard features unless otherwise specified.
2.	Door thickness is 1-3/4" unless otherwise specified.
3.	Split finishes and designs will be priced at the highest list price of the design and/or finish + lock adjustment.
4.	 Light blue shaded cell denotes a lock or part that requires an extended lead time.
5.	 denotes a handed product and requires handing to be specified.
6.	For all restricted keyways (TA, PDQ3) and additional high security and restricted keyways see page 125.
7.	Locks, keys and cylinders containing restricted keyways require additional documentation to order. A letter of authorization on the end user's stationary must be submitted with the initial order to establish the authorized ship to location.
8.	Keyway must be specified for keyed functions and cylinder. If not specified, the default keyway will be SCC.
9.	Multiple keying options are available. Locks and cylinders are furnished KD unless otherwise specified or excepted by notation.
10.	Control Keys for permanent and construction cores are not included with the lock or cylinder and must be ordered separately.
11.	Stamping standards and charges are listed on page 126.
12.	Locks and cylinders will be furnished with 2 keys each as standard. Additional keys will be charged at the additional cut key charge appropriate for the cylinder/key type.

## Customer Support

<b>Customer Service</b>	717.656.4281	<a href="mailto:help@pdqlocks.com">help@pdqlocks.com</a>
<b>Placing Orders</b>		<a href="mailto:orders@pdqlocks.com">orders@pdqlocks.com</a>
<b>Technical Support</b>	833.2-PDQTEC (833.273.7832)	<a href="mailto:support@pdqlocks.com">support@pdqlocks.com</a>
<b>Quotation</b>	717.656.4281	<a href="mailto:quotes@pdqlocks.com">quotes@pdqlocks.com</a>

# This Price List Supersedes and Cancels All Previous Price Lists. Prices Shown are Subject to Change Without Notice.

## Terms & Conditions

### Prices

All prices are subject to change without notice. All prices are per unit (each) unless otherwise specified and do not include freight. All prices are in U.S. dollars.

### Errors and Omissions

While PDQ Manufacturing makes every effort to provide an accurate price list, we are not responsible for errors and/or omissions that may appear. Customers will be invoiced the actual and true price on all orders.

### Credit Terms

Standard credit terms are 1% 10 days net 30. Net 30 days payment must be received by PDQ on or before 30 days from the date of the invoice. Interest will be charged at the rate of 1-1/2% per month on past due accounts. A \$25.00 fee will be charged for all returned payments.

### Acceptance of Orders

Possession of prices from PDQ Manufacturing does not commit PDQ to accept any order. PDQ Industries reserves the right to refuse any order or request for quotation and will not be bound to fill any order until it has been accepted by a representative of PDQ and confirmed by a written acknowledgment. Quotations are valid for the period stated on the official quotation request form. Orders must be submitted in writing.

### Acknowledgments

An Acknowledgment is an exact copy of a customer's order as entered by PDQ and should be verified by the customer. If the Acknowledgment does not agree with customer's understanding, PDQ should be advised within three (3) days or the order will be billed as acknowledged. PDQ Manufacturing's sales terms shall apply irrespective of any special stipulation appearing in customer orders, unless specifically acknowledged and accepted by PDQ Manufacturing, Inc. Estimates of delivery are made by PDQ Manufacturing in good faith and are not guaranteed. PDQ Manufacturing does not assume responsibility for delay in deliveries.

### Product Will Call Orders

Product Will Call orders shall be picked-up within 3 working dates from the available date shown on the acknowledgment. Orders not picked-up after the 3 days shall be subject to cancellation charges.

### Product Return

Products may not be returned unless customer receives written authorization from PDQ. If the return is authorized by PDQ a Return Goods Authorization (RGA) number will be issued to the customer. Products returned must have the RGA number clearly marked on the outside of the box and reach PDQ within 45 days from the date RGA is issued. All documentation and RGA number must accompany the return along with the original invoice number and an explanation why the material is being returned so that PDQ may inspect the material in question. Only material that has been in customer's inventory for less than 60 days from the invoice date, is current standard, non-obsolete and not specially manufactured, unused and in their original condition and original packaging will be considered for return. Master keyed items cannot be returned for credit. If the product is accepted for a return there will be minimum 35% processing charge of the net material value on the original invoice, less freight and cash discounts. Full credit against future purchases or replacements will be made at the option of PDQ. Care must be taken to package all returns to ensure that they are not damaged in shipment. PDQ will not credit items returned that have not been properly packed and as a result sustain damage in shipment back to our facility

### Force Majeure

PDQ will not be held responsible for delays in delivery caused by Strikes, acts by government agencies, fires, floods or any other causes beyond our control, including the delivery of material to us. Under no circumstances shall PDQ be liable or accountable for consequential damages due to failure of delivery.

### Invoices

Copies of invoices and sales orders are posted and accessible on PDQ's website. Contact Customer Service for obtaining secured access authorization. Invoices are in U.S. dollars.

### Minimum Order

Minimum order is \$100 net invoice value at current buying program, less freight.

### Changes or Cancellations

Changes or cancellations to an order acknowledged must be made in writing subject to a 50% cancellation fee.

### Claims

Every possible care is taken in the final examination and packing of goods, and no complaints can be entertained unless made promptly on receipt of goods. No claim will be allowed for work done by others, consequential damages, or other expenditure, and PDQ's undertaking to repair or replace defective goods is its only liability. No claim for damage, shortage or loss in transit will be considered unless notice in writing is given to the carrier and to PDQ Industries within ten (10) days.

### Back Charges

PDQ is not responsible for, does not authorize, and will not accept any charges for the cost of labor or material incurred by anyone other than PDQ Manufacturing for any installation, repair, service or replacement unless incurred with PDQ's prior written consent and agreement.

### Freight Charges

FOB point is Lancaster, PA, Norcross, GA, or Auburn, WA. Ship location is at factory discretion. Freight is prepaid if invoice exceeds \$3,000 net. Air freight and other special shipments are not deductible. Freight allowance methods are at the discretion of PDQ. C.O.D. freight charges are paid by consignee.

### Credit Card Payments

When paying by credit card a 3% surcharge will be added to the invoice at time of payment.

### Discontinuance

PDQ Manufacturing reserves the right to discontinue or change any price, product, design, function and finish without notice.

### Quotations and Invoices

Quotations and Invoices are the proprietary property of PDQ Distributors and the Company. Distributors are not permitted to redistribute quotations or invoices to third parties. Any redistribution may result in the loss of the distributor's rights to the PDQ product line.



# Warranty

## PDQ Manufacturing Limited Warranty

Grade 1 Lock Product	
MR Series Mortise Locks	Limited Lifetime Warranty
XGT Series	Limited Lifetime Warranty
GT Series	25-Year Warranty
SX Series	5-Year Warranty
Grade 2 Lock Product	
GP Series	8-Year Warranty
SD Series	5-Year Warranty
SF Series	3-Year Warranty
SV Series	1-Year Warranty
CL Series	2-Year Warranty
TJ Series Decorative Tubular	
TJ Series	5-Year Warranty
Deadbolts	
K Series	1-Year Warranty
Closers	
3100 Series	25-Year Warranty
5100 Series	25-Year Warranty
5300 Series	25-Year Warranty
5500 Series	25-Year Warranty
7100 Series	25-Year Warranty
Exit Devices	
4200 Series	5-Year Warranty
6300 Series	10-Year Warranty
6400 Series	10-Year Warranty
Mullions	
Mullions	10-Year Warranty
Hinges, Flat Goods and Sliding Barn Door Hardware	
Commercial Hinges	5-Year Warranty
Flat Goods	5-Year Warranty
Sliding Barn Door Hardware	5-Year Warranty
Electrified Products	
Mechanical Components	Series Warranty
Electric Components	2-Year Warranty

PDQ Manufacturing ("PDQ") warrants that, during the applicable warranty period set forth in the chart to the left, its products will be free from defects in workmanship and materials under normal use and service conditions. If a product or a component part thereof is found to be defective, PDQ will, at its sole discretion, either repair or replace such defective item. If PDQ no longer manufactures the particular product or component, PDQ reserves the right to substitute an item which PDQ deems to be comparable or superior in its place.

A warranty claim must be initiated by calling PDQ's toll-free number at 800.441.9692. A brief description of the defect will be required, and further instructions for returning the product will be given. The provision of return instructions is not a guarantee that the product will be covered under this warranty.

This warranty does not cover:

- Defects or damage arising from improper installation; lack of or improper maintenance; improper storage, shipping or handling; corrosion; erosion; ordinary wear and tear; misuse or abuse; or accident.
- Products which have been modified in any way, regardless of whether such modification caused or contributed to the alleged defect.
- The protective coatings and finishes applied to the surface of the product (wear or tarnishing of such finishes is considered "ordinary wear and tear").
- Labor costs, including the costs of removing and reinstalling the product.
- Shipping charges incurred in returning the product to PDQ.
- This Limited Warranty does not apply to ANSI A156.2 Grade 2 Key-In-Lever product installed on Educational Facilities.

All products returned to PDQ will be inspected to verify that (1) the alleged defect does exist, and (2) none of the exclusionary conditions listed above (abuse, corrosion, modification, etc.) is present. Products deemed not to be "in warranty" will be returned to the customer at the customer's expense.

This warranty is exclusive and in lieu of all other warranties, express and implied, including the implied warranties of merchantability and fitness for a particular purpose.

PDQ's maximum liability hereunder is limited to the original purchase price of the product.

PDQ shall not be liable for any incidental, consequential, indirect, special, exemplary or punitive damages, whether based on contract, warranty, tort (including strict liability and negligence), patent infringement or any other theory of liability, even if advised of the possibility of such damage.

No agent, sales representative or dealer has the authority to increase or alter PDQ's obligations under this warranty.





ASSEMBLED  
IN THE USA

## Designed to Over-Perform

Tested to 11 million cycles and still counting! That's how PDQ backs up its claim to manufacture some of the toughest hardware in the market. Our mortise locks are built to withstand the rigors of daily use without fail, keeping people and their assets safe while delivering consistent reliable performance. Easy to install, and simple to repair and maintain. That means fewer callbacks for you and total safety and security for your customers.

### Comprehensive Offering

---

#### MR Mechanical

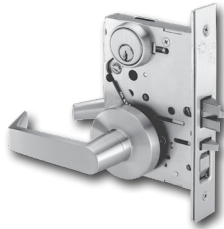

##### Applications

Healthcare, K-12, higher education, offices, commercial buildings and government facilities.

---

#### MR199A Electro-Mechanical

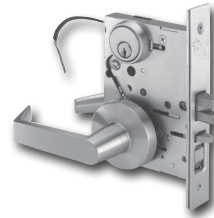

##### Applications

Computer rooms, storage areas, child care facilities, restrooms, nursing staff lounges and stairwell towers.

---

#### MR Visual Indicators



##### Applications

Classroom security, student housing and traditional OCCUPIED/VACANT and LOCKED/UNLOCKED applications.

---

#### TJ Tubular Trim Suite

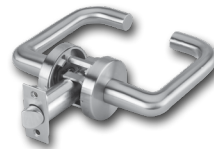

##### Applications

Interior doors in high-end residential, multi-family and commercial spaces. Trim matches MR mortise achieving a coordinated look throughout the property.

## Lock Status at a Glance

PDQ's MR Series mortise lock indicators offer exceptional visibility and flexibility. The unique features of the indicator make it ideally suited for classroom security applications as well as traditional occupied/vacant applications.

### Typical Applications

- Classroom Security
- LOCKED/UNLOCKED Applications
- Student Housing
- Traditional OCCUPIED/VACANT Applications



### Features and Functions

- Conforms to ANSI Z535.1 Safety Colors: Red and Green
- Optional Security Screws Available
- Intruder Deadbolt with Dead-latch for School Security Applications
- Dormitory Security
- Faculty Restroom with Deadbolt w/Indicator
- Privacy w/Indicator
- Privacy with Deadbolt w/Indicator
- Privacy with Deadbolt and Egress w/Indicator



# MR 199A MR200

# Electrified Mortise Solutions



ASSEMBLED  
IN THE USA

## MR199A Electrified Storeroom MR200 Electrified Institutional

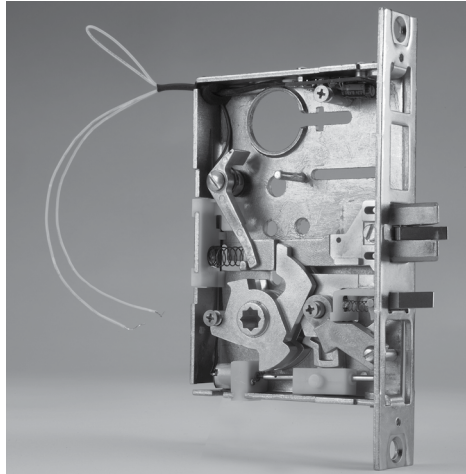

Innovative motor drive controls  
FAIL SECURE or FAIL SAFE locking  
mode.

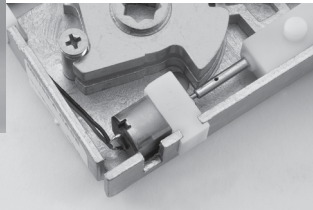

## Typical Applications

- Child Care Facilities
- Computer Rooms
- Nursing Staff Lounges
- Rest Rooms
- Stairwell Towers
- Storage Areas

## Features

- Motorized locking/unlocking.
- **FAIL SECURE** (Factory Default)– Outside trim is UNLOCKED when power is ON, and LOCKED when power is OFF. Lockset will lock in the event of a power failure.
- **FAIL SAFE** – Outside trim is LOCKED when power is ON, and UNLOCKED when power is OFF. Lockset will unlock in the event of a power failure.
- Field changeable from FAIL Secure to FAIL SAFE.
- Built around PDQ's world class MR series mortise lock chassis platform.
- Meets requirements of the Buy American Act.
- SMARTSENSE™ control board automatically accepts AC or DC input voltage.
- Request to exit option.
- Latch bolt monitor option.
- Field reversible handing - consult factory.

## Specifications



<b>PERFORMANCE:</b>	<ul style="list-style-type: none"> <li>• Motor drive factory tested to over 1.4 million cycles (nearly 3x the ANSI/BHMA Grade 1 Standard).</li> </ul>
<b>RECOMMENDED POWER SUPPLY:</b>	<ul style="list-style-type: none"> <li>• PDQ Model # PS220.                             <ul style="list-style-type: none"> <li>– Input: 110-120 VAC 60Hz</li> <li>– Output: 24VDC, 2A, filtered and regulated.</li> </ul> </li> <li>• Rated for simultaneous operation of 2ea mortise lock assemblies.</li> <li>• Power Supply Requirements:                             <ul style="list-style-type: none"> <li>– AC/DC Output Voltage</li> <li>– 1A min (filtered and regulated).</li> </ul> </li> <li>• 12-24VDC @ &lt; 1A initial surge (1 sec), 5mA standby after 30 sec.                             <ul style="list-style-type: none"> <li>– AC Output Voltage.</li> </ul> </li> <li>• 12-24VAC (60Hz) @ &lt; 1A initial surge (1 sec), 15mA standby after 30 sec</li> </ul>
<b>ELECTRICAL SPECIFICATIONS:</b>	<ul style="list-style-type: none"> <li>• Input voltage: 12-24VDC or 12-24VAC.</li> <li>• Max In-rush current: 1.0A.</li> <li>• Standby current:                             <ul style="list-style-type: none"> <li>– 12VAC: 12mA.</li> <li>– 24VAC: 10mA.</li> <li>– 12VDC: 3mA.</li> <li>– 24VDC: 5mA.</li> </ul> </li> </ul> <p>Note: Operating voltage at ± 10% of rated voltage.</p>
<b>CERTIFICATIONS, LISTINGS, COMPLIANCES:</b>	<ul style="list-style-type: none"> <li>• ANSI/UL10C and CAN/ULC-5104 Listed for "Fire Exit Hardware" up to 3 hours for 4'0" x 8'0" maximum single, 8'0" x 8'0" maximum pairs.</li> <li>• Assembled in the U.S.A. with U.S. and foreign material. Meets requirements of the Buy American Act as a COTS product manufactured in the United States.</li> </ul>
<b>WARRANTY:</b>	<ul style="list-style-type: none"> <li>• 2-Years</li> </ul>

# MR SERIES

# Grade 1 Mortise



ASSEMBLED  
IN THE USA

## Typical Applications

- Assisted Living
- Government Facilities
- Healthcare
- Hospitality
- Houses of Worship
- Industrial
- Multi-family
- Offices
- Public Buildings
- Retail
- Higher Education
- K-12 Education

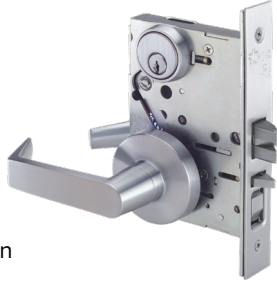

## Specifications



<b>FOR DOORS:</b>	• 1-3/4" standard, 2"-3" thick doors available as special order
<b>BACKSET:</b>	• 2-3/4"
<b>CASE:</b>	• 12-gauge cold rolled steel mechanism • Dichromated for corrosion resistance • Features weakened spindle design to prevent case damage
<b>ARMOR FRONT:</b>	• Beveled 1/8" on 2" • 625 (US26) & 630 (US32D) use stainless steel as base material, all other finishes use stainless steel or brass as base material
<b>STRIKE:</b>	• Non-handed Curved Lip Strike • 625 (US26) & 630 (US32D) use stainless steel as base material, all other finishes use stainless steel or brass as base material
<b>LEVERS:</b>	• F Series Sectional/Escutcheon: Philadelphia, Boston, Miami • J Series Sectional/Escutcheon: Philadelphia, Boston, Miami, Chicago, Dallas, Houston, Los Angeles, Memphis, Orlando, Ball Knob
<b>LATCHBOLT:</b>	• 3/4" Throw • Investment Cast Stainless Steel • Anti-friction
<b>DEADBOLT:</b>	• 1" Throw • Investment Cast Stainless Steel
<b>HAND:</b>	• Most functions field reversible. Specify handing for Strikes, consult factory for details
<b>TRIM:</b>	• F trim - forged brass levers and escutcheons • Round and square rose available • J Trim - stainless steel sectional/escutcheon trim and levers, PHL, MEM, MIA and BSN are solid levers LAX, ORL, DAL and CHI are tube levers
<b>KEYS:</b>	• Two (2) per Lock
<b>KEYWAYS:</b>	• SCC standard (Schlage C Compatible) • Also available in keyways of other manufacturers
<b>INTERCHANGEABLE CORE:</b>	• 6 or 7-pin • Compatible with Best, Falcon & Arrow • Large Format IC Cores compatible with Schlage.
<b>CYLINDER:</b>	• 6 or 7-pin Brass Mortise Cylinder • Standard High Security and UL437 Cylinders Available
<b>KEYING:</b>	• Options: MK, CMK or GMK • Zero Bitted (KO), Keyed Different (KD) or Keyed Alike (KA) Can be keyed into existing master key systems
<b>FINISHES:</b>	• F Series Trim: 626 (US26D) • J Trim: 605 (US3), 606 (US4), 612 (US10), 613E, 622 (US19), 629 (US32), 630 (US32D) • Antimicrobial Coating available on 626 (US26D) & 630 (US32D) for F and J Trim.
<b>PERFORMANCE:</b>	• Tested to over 11 million cycles, 11X ANSI/BHMA standard
<b>CERTIFICATIONS, LISTINGS, COMPLIANCES:</b>	• UL listed for 3 hrs, for single doors up to 4'0" x 8'0" • Certified to ANSI/BHMA 156.13 Operational Grade 1 and Security Grade 1 • Approved for Florida HVHZ (High Velocity Hurricane Zone). PDQ Product Approval: FL 21376. Design load rating: ± 70.0 PSF for single door (3' x 7') • Complies with ADA (Americans with Disabilities Act) and ICC/ANSI 117.1 for Accessible and Usable Buildings • J Wide Escutcheon Trim complies with Unified Facilities Guide Specification 08 71 00 (August 2008)
<b>WARRANTY:</b>	• Lifetime Limited Warranty
<b>COUNTRY OF ORIGIN:</b>	• Assembled in the U.S.A. with U.S. and foreign material. Meets requirements of the Buy American Act as a COTS product manufactured in the United States.

**Note:** Heavy Duty Spindle for High Abuse situations is available for F trim.

‡ Available with antimicrobial coating, technology that is known to inhibit the growth of microbes.

## How to Order

SERIES	FUNCTION	LEVER	TRIM	FINISH	HANDING <sup>1</sup>	DOOR THICKNESS	CYLINDER	KEYWAY OR HOUSING	KEYING	OPTIONS
MR	136	PF	EF	626	RH	134	D	SCC	KD	—
	PAGE 12	<u>F-TRIM</u> PF — PHL BF — BSN MF — MIA  <u>J-TRIM</u> PJ — PHL BJ — BSN MJ — MIA CJ — CHI DJ — DAL HJ — HOU LJ — LA TJ — MEM OJ — ORL KJ —K	<u>F-TRIM</u> EF — Escutch- eon SF — Sectional Round Rose  <u>J-TRIM</u> EJ — Standard Escutch- eon EW — Wide Escutch- eon SJ — Sectional Round Rose SR — Sectional Square Rose	605 606 612 613E 622 626 630	RH — Right Hand (Default) RHR — Right Hand Reverse LH — Left Hand LHR — Left Hand Reverse	134 — 1-3/4" 214 — 2-1/4"	D Default L Less Cylinder SF6 Lock is SFIC prepped w/ 6 pin core SF7 Lock is SFIC prepped w/ 7 pin core SFL Lock is SFIC prepped but less core SFC Lock is SFIC prepped w/ construction core SFP Lock is SFIC prepped w/ plastic construction core LF6 Lock is Schlage LFIC prepped w/ Schlage core LFL Lock is Schlage LFIC prepped but less core LFC Lock is Schlage LFIC prepped w/ construction core	PAGE 14	PAGE 14	REX — Request to Exit (Functions 199A and 200only). ISM - Industry Standard Molex Connector AM — Antimicrobial Coating. LL — Lead Wrapped Case. W - Weatherized (F Trim Only)  Additional options available  *All thumbturns will now be ADA by default
										PAGE 15

**NOTES:**

- 1 - Specify handing for all functions
- 2 - For Split Finishes, Contact PDQ Customer Service
- 3 - Compatible with all F, J and JW Series trim, any Sectional or Escutcheon.

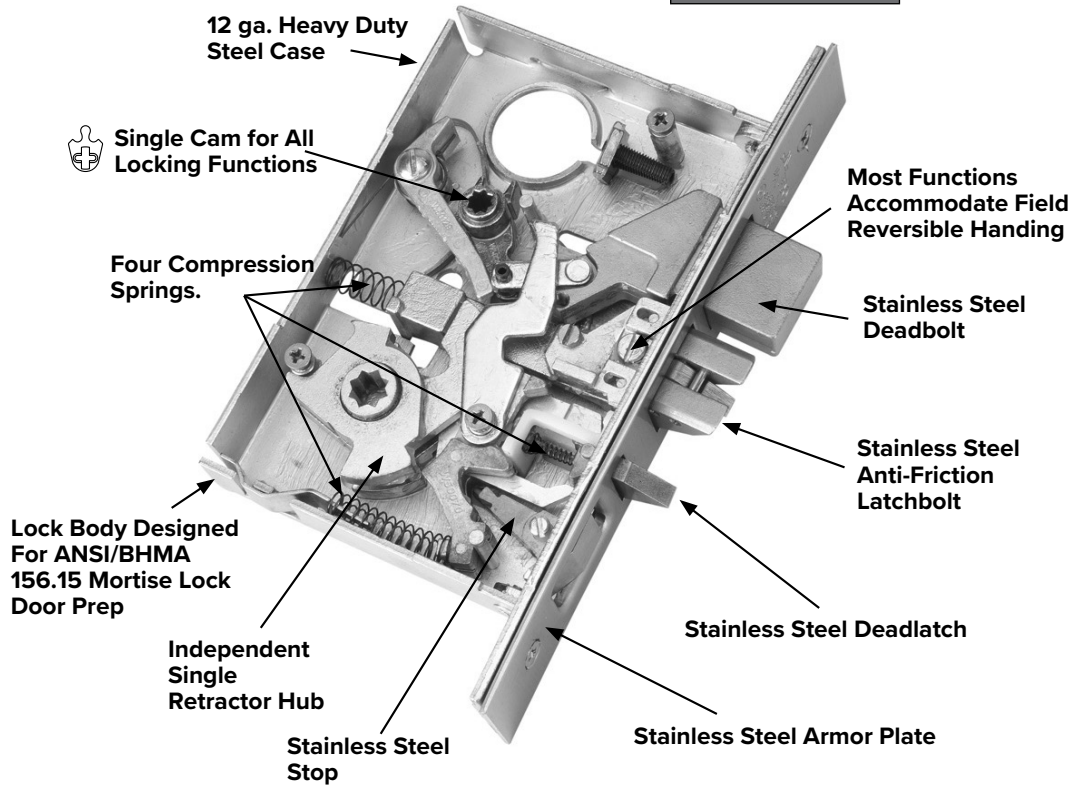

# MR SERIES

# LIST PRICE

Effective July 3, 2023

## Locksets/Trim

**Notes:**

- 1 - Lock adjustment for Square Rose, Wide J Trim, see page 13.
- 2 - Finishes 605, 606 and 612 consult factory for lead-time.
- 3 - F-Trim available in 626 only.

SECTIONAL			ESCUTCHEON		
SERIES:	F SERIES	J SERIES	F SERIES	J SERIES	
LEVERS:	PHL, BSN, MIA	ALL LEVERS & KNOB	PHL, BSN, MIA	ALL LEVERS & KNOB	
ROSE/ESCUTCHEON:	ROUND (SF)	ROUND (SJ) SQUARE (SR)	(EF) 2-1/16" W x 7-5/8" H	STANDARD (EJ): 1-3/4" W x 7-5/8" H WIDE (EW): 2-9/16" W x 8" H	

	ANSI NO.	FUNCTION	DESCRIPTION	626	630	605, 606, 612, 613E, 622, 629	626	630	605, 606, 612, 613E, 622, 629
NON-KEYED	F01	126	Passage	\$550.00	\$520.00	\$570.00	\$580.00	\$550.00	\$610.00
		174	Privacy with Thumbturn Both Sides	\$630.00	\$600.00	\$650.00	\$660.00	\$630.00	\$690.00
	F22	176	Privacy						
SINGLE CYLINDER	F06	113	Classroom Hold back Single Cyl	\$660.00	\$630.00	\$680.00	\$690.00	\$660.00	\$720.00
	F07	115	Storeroom						
	F04	116	Entry						
		148	Classroom						
		149	Assisted Living						
	181	Office							
DOUBLE CYLINDER		114	Classroom Hold back Double Cyl	\$730.00	\$700.00	\$750.00	\$760.00	\$730.00	\$790.00
	F30	138	Institution						
	F09	186	Apartment Entrance						
NON-KEYED WITH DEADBOLT	F02	178	Privacy with Deadbolt	\$700.00	\$670.00	\$720.00	\$730.00	\$700.00	\$760.00
	F19	179	Privacy with Deadbolt and Egress						
SINGLE CYLINDER WITH DEADBOLT	F08	117	Front Door	\$685.00	\$655.00	\$705.00	\$715.00	\$685.00	\$745.00
	F21	135	Entrance, Storeroom						
	F13	136	Dormitory, Entrance						
		139	Closet, Storeroom						
		141	Storeroom with Deadbolt						
	F10	154	Entrance						
	F20	162	Apartment, Corridor						
		213	Double Cylinder and Thumbturn Deadbolt with Dummy Trim						
	215	Single Cylinder Deadbolt with Dummy Trim							
DOUBLE CYLINDER WITH DEADBOLT		128	Institution with Deadbolt	\$750.00	\$720.00	\$770.00	\$780.00	\$750.00	\$810.00
	F14	137	Store Door						
	F34	157	Intruder Deadbolt with Deadlatch						
	F11	158	Dormitory						
	F33	159	Dormitory						
	214	Double Cylinder and Thumbturn Deadbolt with Dummy Trim							
DEADLOCK	F18	131	Single Cylinder Deadbolt	\$420.00	\$390.00	\$440.00			
	F17	132	Cylinder and Thumbturn Deadbolt						
	F16	133	Double Cylinder Deadbolt	\$430.00	\$400.00	\$450.00			
	F29	134	Classroom Deadbolt						
ELECTRIFIED		199A	Storeroom, Single Cylinder	\$1030.00	\$1000.00	\$1050.00	\$1060.00	\$1030.00	\$1090.00
		200	Institutional, Double Cylinder	\$1060.00	\$1030.00	\$1080.00	\$1090.00	\$1060.00	\$1120.00
WITH INDICATORS		232	Privacy Single Cylinder Deadbolt w/Indicator	N/A	\$750.00	\$800.00	N/A	\$780.00	\$840.00
	F13	236	Dormitory, Entrance w/Indicator						
		241	Storeroom with Deadbolt w/Indicator						
	F34*	257	Intruder w/Indicator						
	F33*	259	Dormitory w/Indicator						
	F15*	260	Faculty Restroom w/Deadbolt w/Indicator						
		269	Privacy w/Indicator						
	F22*	276	Privacy w/Indicator						
	F02*	278	Privacy w/Deadbolt w/Indicator						
F19*	279	Privacy w/Deadbolt and Egress w/Indicator							
DUMMY/ DUMMY TRIM		205	Double Dummy	\$390.00	\$360.00	\$410.00	\$420.00	\$390.00	\$450.00
		206	Double Dummy with Chassis	\$490.00	\$460.00	\$510.00	\$520.00	\$490.00	\$550.00
		207	Double Dummy with Active Trim						
		211	Single Dummy	\$210.00	\$180.00	\$205.00	\$240.00	\$210.00	\$240.00
		212	Single Dummy with Chassis	\$310.00	\$280.00	\$330.00	\$340.00	\$310.00	\$370.00

\*w/Indicator

## J Series Rose and Escutcheon Lock Adjustment

CODE	DESCRIPTION	LOCK ADJUSTMENT
		630, 605, 606, 612, 613E, 622, 629
SR	Sectional Square Rose - J Trim	\$20.00
EJ	Standard Width Escutcheon - J Trim Dimensions: 1-3/4" W x 7-5/8" H	N/C
EW	Wide Width Escutcheon - J Trim Dimensions: 2-9/16" W x 8" H	\$10.00 (Additional add to EJ List Price)
SJ	Sectional Round Rose - J Trim	N/C

### F Type Levers



PHILADELPHIA — PF



BOSTON — BF



MIAMI — MF

### J Type Levers



PHILADELPHIA — PJ



BOSTON — BJ



MIAMI — MJ



CHICAGO — CJ



DALLAS — DJ



HOUSTON — HJ



MEMPHIS — TJ



ORLANDO — OJ

(Specify handing)



LOS ANGELES — LJ



BALL KNOB — KJ\*



**ALL LEVERS**

\*Knobs are not ADA Compliant

CYLINDER OPTIONS	ICON
D	
SFL	
LFL	

IC Core not included see page 15 for core options

### Sectional Trim



ROUND ROSE (SF)  
F-TRIM



SQUARE ROSE (SR)  
J-TRIM ONLY



ROUND ROSE (SJ)  
J-TRIM

### Escutcheon Trim



EF  
STANDARD F



EJ  
STANDARD J



EW  
WIDE J

# MR SERIES

## LIST PRICE

Effective July 3, 2023

PDQ KEYWAY	COMPATIBLE WITH	SOLD WITH LOCK
AR1	Arrow / AR1	N/C
CO59A1	Corbin / 59A1	
CO6	Corbin / 60	
CL4	Corbin / L4	
RUD	Ruswin / D1	
SCE	Schlage / E	
SCC	Schlage / C	
SCC-K	Schlage / C-K	
SAL	Sargent / LA	
RA-RC	Sargent / RA-RC	
YA8	Yale / E1R	
GA	Yale / GA	
FAL	Falcon / E-R	
KW	Kwikset	
TA	PDQ / TA (Restricted. Limited to Grandmaster systems w/4 masters)	
Dummy	—	
T-Turn	—	
L	Less Cylinder	Deduct \$4.00
<b>HIGH SECURITY CYLINDERS AND CORES</b>		
SEE HIGH SECURITY CYLINDERS AND CORES SECTION, PAGE 118.		

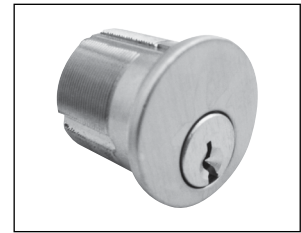

Mortise Cylinder

**NOTES:**

- Uncombined cores do not include springs & pins
- Combined cores include master keying in the list price
- **PDQ1, PDQ2, PDQ3 (Restricted)**  
BEST A2 & A4 Systems Available
- Control Keys must be ordered separately

## Cores and Keyways

DESCRIPTION	PDQ NO.	ADD
<b>SMALL FORMAT UNCOMBINED</b>		
6 Pin Cores	I5206 + KEYWAY	\$40.00
7 Pin Cores	I5207 + KEYWAY	
<b>COMBINATED</b>		
6 Pin Cores	I5206-1 + KEYWAY	\$60.00
7 Pin Cores	I5207-1 + KEYWAY	
<b>BEST Compatible</b>		
A (DEFAULT), B, C, D, E, F, G, H, J, K, L, M, Q,		
WA, WB, WC, WG, WH, TB, TD, TE, & R		
<b>PDQ Exclusive</b>		
PDQ1, PDQ2		
<b>PDQ Exclusive and Restricted</b>		
PDQ3		
<b>SFIC CONSTRUCTION</b>		
Construction Core 6-pin only		\$60.00
Dummy Construction Core Plastic		\$8.00
<b>LFIC CONSTRUCTION</b>		
Construction Core 6-pin only. <b>Construction cores are invoiced at shipment and credited upon return.</b>		\$70.00
<b>IC Tailpiece Assembly</b>		
		\$10.00
<b>LFIC COMBINATED</b>		
Schlage compatible LFIC, SCC (Schlage C compatible) keyway		\$70.00
PDQ TA LFIC Restricted		
<b>LFIC UNCOMBINED</b>		
Schlage compatible LFIC, SCC (Schlage C compatible) keyway		\$50.00
<b>HIGH SECURITY IC CORES</b>		

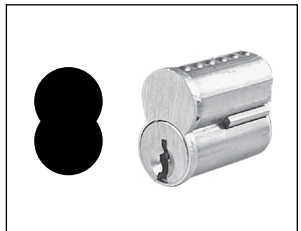

SFL/SFIC Core

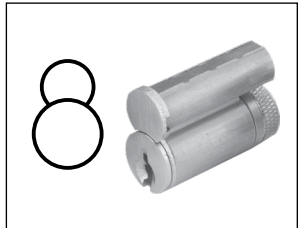

LFL/LFIC Schlage Format



IC Mortise Housing



### Options

\*All thumbturns will now be ADA by default

CODE	DESCRIPTION	LOCK ADJUSTMENT
TC1S	Tactile Abrasive Coating - Inside only (PHL and MIA levers only)	\$25.00
TC1OS	Tactile Abrasive Coating - Outside only (PHL and MIA levers only)	
TC2	Tactile Abrasive Strip - Both Sides (PHL and MIA levers only)	\$50.00
SSM	Sectional Single Sided Mounting Assembly	
LL	Lead-wrapped Case	\$185.00
SHS	Security Head Screws	\$15.00
EASA	Extended Lip Strike (1-3/8, 1-5/8, 1-7/8)	\$10.00
REX	Request to Exit (Available for functions 199A and 200 only)	\$185.00
ISMC	Industry Standard Molex Connector (Order in addition to other electrified options)	\$108.00
LM	Latch Bolt Monitoring (Available with functions MR113, MR115, MR116, MR126, MR138, MR148, MR199A, and MR200 only)	\$185.00
SF	Split Finishes	Higher Finish Price
HDS	HD Spindle for high abuse applications (for F Trim Only)	\$35.00
AM	Antimicrobial Coating - Sectional Mortise Lock inside lever, rose, thumbturn, outside lever (Not available with 605 finish)	
AM	Antimicrobial Coating - Escutcheon Mortise Lock inside lever, rose, thumbturn, outside lever (Not available with 605 finish)	
W	Weatherized Finish - for F Trim Only	\$80.00
TD1	MR adapted to accommodate 2-1/4" thick door (sectional trim)	\$65.00
TD2	MR adapted to accommodate 2-1/2" thick door (sectional trim)	
TD3	MR adapted to accommodate 2-3/4" to 3" thick door (sectional trim)	
TD4	MR adapted to accommodate 2-1/4" thick door (escutcheon trim)	
TD5	MR adapted to accommodate 2-1/2" to 2 3/4" thick door (escutcheon trim)	
TD6	MR adapted to accommodate 3" thick door (escutcheon trim)	
TD1	MR adapted to accommodate 2-1/4"-2-1/2" thick door	\$65.00
TD2	MR adapted to accommodate 2-3/4" thick door	
TD3	MR adapted to accommodate 3" thick door	



### Thick Door Installation Kits

DESCRIPTION	PDQ NO.	LIST PRICE
<b>J TRIM SECTIONAL</b>		\$150.00
2-1/2" door	W51447	
2-3/4" to 3" door	W51448	
<b>J TRIM ESCUTCHEON AND ESCUTCHEON WIDE</b>		
2-1/2 -2-3/4" door	W51449	
3" door	W51450	

Note: Kits include hardware to install lock in center of door. Cylinders and strikes not included.

## Strikes

DESCRIPTION	LIP LENGTH	PDQ NO.	LIST PRICE
1-1/4" x 4-7/8" ANSI/ASA Curved Lip (NON-HANDED)	1-3/16"	W51290-(designate finish)	\$30.00
Extended Straight Lip	1-7/8"	W51002-(designate finish)	\$40.00

## Mortise Lock Body with Armor Plate

TYPE	LOCK BODY BY FUNCTION	PDQ NO.	LIST PRICE
Non-Keyed	126, 174, 176	Contact Customer Support	\$265
Non-Keyed Deadbolt	178, 179		\$290
Single Cylinder	113, 115, 116, 148, 149, 181		\$300
Single Cylinder Deadbolt	117, 135, 136, 139, 141, 154, 162, 213, 215		\$330
Double Cylinder	114, 138, 186		\$300
Double Cylinder Deadbolt	128, 137, 157, 158, 159, 214		\$330
Electrified	199A / 200		\$500
Electrified w/ REX	199A / 200 REX		\$685

## Sectional Trim Packs\* (Lever and Rose)

DESCRIPTION	PDQ NO.	LIST PRICE
Full Sectional Trim Pack (both sides of door), "F" or "J" Trim, All Functions*	Contact Customer Support	\$400.00
Half Sectional Trim Pack (one side of door), "F" or "J" Trim, All Functions*		\$200.00

\* Note - Cylinders priced separate, See cylinders page 130

## Escutcheon Trim Packs\* (Lever and Escutcheon)



DESCRIPTION	PDQ NO.	LIST PRICE
Full Escutcheon Trim Pack (both sides of door), "F" or "J" Trim, All Functions*	Contact Customer Support	\$450.00
Half Escutcheon Trim Pack (one side of door), "F" or "J" Trim, All Functions*		\$225.00

\* Note - Cylinders priced separate, See cylinders page 130





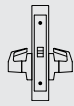
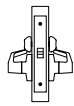

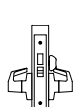
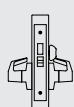
### Miscellaneous Parts

DESCRIPTION	PDQ NO.	LIST PRICE
Cam (Corbin A01) For #16 mortise Cylinder	I127-4201	\$10.00
IC Cam for SFIC Mortise Housing	I54061	
IC Cam for LFIC Mortise housing	I54261	
Collar Cyl Vandal 3/8" (specify finish)	W51214	\$20.00
Collar Spring	W51049	\$8.00
Anti-Friction Latchbolt	W91904	\$40.00

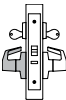

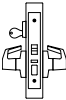

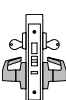

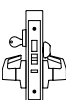
### PDQ Functions – Non Keyed

FUNCTION	FUNCTION NUMBER	OUTSIDE   INSIDE	DESCRIPTION	ANSI NUMBER
Passage	MR126		<ul style="list-style-type: none"> <li>Latchbolt operated by lever from either side</li> </ul>	F01
Privacy with Thumbturn on Both Sides	MR174		<ul style="list-style-type: none"> <li>Latchbolt operated by lever from either side</li> <li>Thumbturn outside locks/unlocks outside lever</li> <li>Thumbturn inside locks/unlocks outside lever</li> <li>Closing door unlocks outside lever</li> <li>Rotating inside lever unlocks outside lever</li> </ul>	—
Privacy	MR176		<ul style="list-style-type: none"> <li>Latchbolt operated by lever from either side</li> <li>Emergency coin turn outside unlocks outside lever</li> <li>Thumbturn inside locks/unlocks outside lever</li> <li>Closing door unlocks outside lever</li> <li>Rotating inside lever unlocks outside lever</li> </ul>	F22
Privacy with Deadbolt	MR178		<ul style="list-style-type: none"> <li>Latchbolt operated by lever from either side</li> <li>Emergency coin turn outside retracts deadbolt</li> <li>Thumbturn inside extends/retracts deadbolt</li> <li>Not field reversible</li> <li>Specify handing</li> </ul>	F02
Privacy with Deadbolt and Egress	MR179		<ul style="list-style-type: none"> <li>Latchbolt operated by lever from either side</li> <li>Emergency coin turn outside retracts deadbolt</li> <li>Thumbturn inside extends/retracts deadbolt</li> <li>Inside lever simultaneously retracts latchbolt and deadbolt</li> </ul>	F19

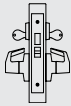
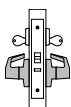
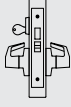
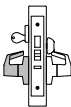
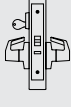

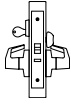

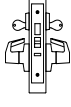

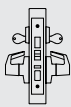
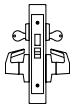
## PDQ Functions – Keyed

FUNCTION	FUNCTION NUMBER	OUTSIDE   INSIDE	DESCRIPTION	ANSI NUMBER
Hold Back Single Cylinder	MR113		<ul style="list-style-type: none"> <li>Latchbolt operated by lever from inside</li> <li>Key outside retracts latchbolt</li> <li>Rigid outside lever</li> <li>Auxiliary latch deadlocks latchbolt</li> <li>Key outside secures latchbolt when latchbolt is retracted by inside lever</li> <li>Not field reversible</li> <li>Specify handing</li> </ul>	F06
Hold Back Double Cylinder	MR114		<ul style="list-style-type: none"> <li>Latchbolt operated by lever from inside</li> <li>Key outside retracts latchbolt</li> <li>Rigid outside lever</li> <li>Auxiliary latch deadlocks latchbolt</li> <li>Key inside secures latchbolt when latchbolt is retracted by inside lever</li> <li>Not field reversible</li> <li>Specify handing</li> </ul>	—
Storeroom	MR115		<ul style="list-style-type: none"> <li>Latchbolt operated by lever from inside</li> <li>Key outside retracts latchbolt</li> <li>Rigid outside lever</li> <li>Auxiliary latch deadlocks latchbolt</li> </ul>	F07
Entry	MR116		<ul style="list-style-type: none"> <li>Latchbolt operated by lever from either side</li> <li>Toggle locks/unlocks outside lever</li> <li>Key outside retracts latchbolt</li> <li>Auxiliary latch deadlocks latchbolt</li> </ul>	F04
Front Door	MR117		<ul style="list-style-type: none"> <li>Latchbolt operated by lever from either side</li> <li>Toggle locks/unlocks outside lever</li> <li>Key outside retracts latchbolt</li> <li>Key outside extends/retracts deadbolt</li> <li>Thumbturn inside extends/retracts deadbolt</li> </ul>	F08 or F10
Institution with Deadbolt	MR128		<ul style="list-style-type: none"> <li>Key outside retracts latchbolt</li> <li>Key inside retracts latchbolt</li> <li>Key outside extends/retracts deadbolt</li> <li>Key inside extends/retracts deadbolt</li> <li>Rigid outside lever</li> <li>Rigid inside lever</li> <li>Auxiliary latch deadlocks latchbolt</li> </ul>	—
Entrance/Storeroom	MR135		<ul style="list-style-type: none"> <li>Latchbolt operated by lever from either side</li> <li>Key outside extends/retracts deadbolt</li> <li>Thumbturn inside extends/retracts deadbolt</li> </ul>	F21
Dormitory/Exit	MR136		<ul style="list-style-type: none"> <li>Latchbolt operated by lever from either side</li> <li>Key outside extends/retracts deadbolt</li> <li>Thumbturn inside extends/retracts deadbolt</li> <li>Extending deadbolt locks latchbolt and outside lever</li> <li>Inside lever simultaneously retracts latchbolt and deadbolt</li> <li>Auxiliary latch deadlocks latchbolt</li> </ul>	F13

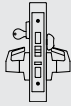
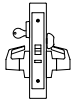
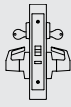
### PDQ Functions – Keyed

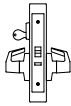
FUNCTION	FUNCTION NUMBER	OUTSIDE   INSIDE	DESCRIPTION	ANSI NUMBER
Store Door	MR137		<ul style="list-style-type: none"> <li>Latchbolt operated by lever from either side</li> <li>Key outside extends/retracts deadbolt</li> <li>Key inside extends/retracts deadbolt</li> <li>Latchbolt and deadbolt are independent of each other</li> </ul>	F14
Institution	MR138		<ul style="list-style-type: none"> <li>Key outside retracts latchbolt</li> <li>Key inside retracts latchbolt</li> <li>Rigid outside lever</li> <li>Rigid inside lever</li> <li>Auxiliary latch deadlocks latchbolt</li> </ul>	F30
Closet / Storeroom	MR139		<ul style="list-style-type: none"> <li>Latchbolt operated by lever from either side</li> <li>Key outside extends/retracts deadbolt</li> </ul>	—
Storeroom with Deadbolt	MR141		<ul style="list-style-type: none"> <li>Latchbolt operated by lever from inside</li> <li>Key outside retracts latchbolt</li> <li>Key outside extends/retracts deadbolt</li> <li>Rigid outside lever</li> <li>Inside lever simultaneously retracts latchbolt and deadbolt</li> <li>Auxiliary latch deadlocks latchbolt</li> <li>Thumbturn inside extends/contracts deadbolt but doesn't effect outside lever</li> </ul>	—
Classroom	MR148		<ul style="list-style-type: none"> <li>Latchbolt operated by lever from either side</li> <li>Key outside locks/unlocks outside lever</li> <li>Inside lever always free</li> <li>Auxiliary latch deadlocks latchbolt</li> </ul>	
Assisted Living	MR149		<ul style="list-style-type: none"> <li>Latchbolt operated by lever from either side</li> <li>Key outside locks/unlocks outside lever</li> <li>Thumbturn inside locks/unlocks outside lever</li> <li>Closing door unlocks outside lever</li> <li>Rotating inside lever unlocks outside lever</li> <li>Auxiliary latch deadlocks latchbolt</li> </ul>	—
Entrance	MR154		<ul style="list-style-type: none"> <li>Latchbolt operated by lever from either side</li> <li>Toggle locks/unlocks outside lever</li> <li>Key outside retracts latchbolt</li> <li>Key outside extends/retracts deadbolt</li> <li>Thumbturn inside extends/retracts deadbolt</li> <li>Inside lever simultaneously retracts latchbolt and deadbolt</li> <li>Auxiliary latch deadlocks latchbolt</li> <li>Projecting then retracting the deadbolt releases the toggle</li> </ul>	—
Intruder Deadbolt with Deadlatch	MR157		<ul style="list-style-type: none"> <li>Latchbolt operated by lever from either side</li> <li>Key outside extends/retracts deadbolt</li> <li>Key inside extends/retracts deadbolt</li> <li>Extending deadbolt locks latchbolt and outside lever</li> <li>Inside lever simultaneously retracts latchbolt and deadbolt</li> <li>Auxiliary latch deadlocks latchbolt</li> </ul>	
Dormitory	MR158		<ul style="list-style-type: none"> <li>Latchbolt operated by lever from either side</li> <li>Toggle locks/unlocks outside lever</li> <li>Key outside extends/retracts deadbolt</li> <li>Key inside extends/retracts deadbolt</li> <li>Inside lever simultaneously retracts latchbolt and deadbolt</li> <li>Auxiliary latch deadlocks latchbolt</li> </ul>	F11
Dormitory	MR159		<ul style="list-style-type: none"> <li>Latchbolt operated by lever from either side</li> <li>Key outside extends/retracts deadbolt</li> <li>Key inside extends/retracts deadbolt</li> <li>Inside lever simultaneously retracts latchbolt and deadbolt</li> </ul>	F33

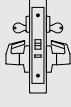
## PDQ Functions – Keyed

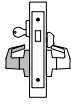
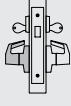
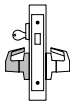
FUNCTION	FUNCTION NUMBER	OUTSIDE   INSIDE	DESCRIPTION	ANSI NUMBER
Apartment/ Corridor	MR162		<ul style="list-style-type: none"> <li>Latchbolt operated by lever from either side</li> <li>Toggle locks/unlocks outside lever</li> <li>Key outside retracts latchbolt</li> <li>Key outside extends/retracts deadbolt</li> <li>Thumbturn inside extends/retracts deadbolt</li> <li>Inside lever simultaneously retracts latchbolt and deadbolt</li> <li>Auxiliary latch deadlocks latchbolt</li> </ul>	F20
Office	MR181		<ul style="list-style-type: none"> <li>Latchbolt operated by lever from either side</li> <li>Key outside locks/unlocks outside lever</li> <li>Thumbturn inside locks/unlocks outside lever</li> <li>Closing door unlocks outside lever</li> <li>Rotating inside lever unlocks outside lever</li> <li>Auxiliary latch deadlocks latchbolt</li> </ul>	—
Apartment	MR186		<ul style="list-style-type: none"> <li>Latchbolt operated by lever from either side</li> <li>Key inside locks/unlocks outside lever</li> <li>Key outside retracts latchbolt</li> <li>Auxiliary latch deadlocks latchbolt</li> <li>Not Field Reversible</li> </ul>	F09
Electrified Storeroom	 MR199A		<ul style="list-style-type: none"> <li>Key outside retracts latchbolt</li> <li>Latchbolt operated by lever from inside</li> <li>Auxiliary latch deadlocks latchbolt</li> <li>Fail safe – latchbolt operated by lever from outside unless electrically locked</li> <li>Fail secure – latchbolt operated by lever from outside when electrically unlocked</li> <li>Motor drive locking/unlocking</li> <li>Not field reversible</li> <li>Specify handing</li> </ul> <p> • Available with option: REX - Request to Exit</p>	—
Electrified Institutional	 MR200		<ul style="list-style-type: none"> <li>Key outside retracts latchbolt</li> <li>Key inside retracts latchbolt</li> <li>Auxiliary latch deadlocks latchbolt</li> <li>Fail safe – latchbolt operated by either lever when electrically locked</li> <li>Fail secure – latchbolt operated by either lever when electrically unlocked</li> <li>Motor drive locking/unlocking</li> <li>Not field reversible</li> <li>Specify handing</li> </ul> <p> • Available with option: REX - Request to Exit</p>	—
Cylinder and Thumbturn Deadbolt with Dummy Trim	MR213		<ul style="list-style-type: none"> <li>Key outside extends/retracts deadbolt</li> <li>Thumbturn inside extends/retracts deadbolt</li> <li>Rigid outside lever</li> <li>Rotating inside lever retracts deadbolt</li> </ul>	—
Double Cylinder Deadbolt with Dummy Trim	MR214		<ul style="list-style-type: none"> <li>Key outside extends/retracts deadbolt</li> <li>Key inside extends/retracts deadbolt</li> <li>Rigid outside lever</li> <li>Rotating inside lever retracts deadbolt</li> </ul>	—
Single Cylinder Deadbolt with Dummy Trim	MR215		<ul style="list-style-type: none"> <li>Key outside extends/retracts deadbolt</li> <li>Rigid outside lever</li> <li>Rotating inside lever retracts deadbolt</li> </ul>	—

# MR SERIES

## LIST PRICE

Effective July 3, 2023

### PDQ Indicator Functions

- Locked/Unlocked Indicator conforms with ANSI Z535.1 Safety Colors: Red and Green.









Shown with optional Security Screws. For more information, contact PDQ Customer Service.

FUNCTION	FUNCTION NUMBER	OUTSIDE   INSIDE	DESCRIPTION	ANSI NUMBER
Dormitory/ Exit w/Indicator	MR236		<ul style="list-style-type: none"> <li>• Latchbolt operated by lever from either side</li> <li>• Key outside extends/retracts deadbolt</li> <li>• Thumbturn inside extends/retracts deadbolt</li> <li>• Inside lever simultaneously retracts latchbolt and deadbolt</li> <li>• Auxiliary latch deadlocks latchbolt</li> <li>• Indicator, outside — (LOCKED/UNLOCKED)</li> </ul>	F13
Storeroom with Deadbolt w/Indicator	MR241		<ul style="list-style-type: none"> <li>• Latchbolt operated by lever from inside</li> <li>• Key outside retracts latchbolt</li> <li>• Key outside extends/retracts deadbolt</li> <li>• Rigid outside lever</li> <li>• Inside lever simultaneously retracts latchbolt and deadbolt</li> <li>• Auxiliary latch deadlocks latchbolt</li> <li>• Thumbturn inside extends/contracts deadbolt but doesn't effect outside lever.</li> <li>• Indicator, outside — (LOCKED/UNLOCKED)</li> </ul>	—
Intruder Deadbolt with Deadlatch	MR257		<ul style="list-style-type: none"> <li>• Latchbolt operated by lever from either side</li> <li>• Key outside extends/retracts deadbolt</li> <li>• Key inside extends/retracts deadbolt</li> <li>• Inside lever simultaneously retracts latchbolt and deadbolt</li> <li>• Auxiliary latch deadlocks latchbolt</li> <li>• Indicator, inside — (LOCKED/UNLOCKED)</li> </ul>	F34 w/Indicator
Intruder Deadbolt	MR259		<ul style="list-style-type: none"> <li>• Latchbolt operated by lever from either side</li> <li>• Key outside extends/retracts deadbolt</li> <li>• Key inside extends/retracts deadbolt</li> <li>• Inside lever simultaneously retracts latchbolt and deadbolt</li> <li>• Indicator, inside — (VACANT/OCCUPIED)</li> </ul>	F33 w/Indicator
Faculty Restroom with Deadbolt w/Indicator	MR260		<ul style="list-style-type: none"> <li>• Latchbolt retracted by key outside or lever inside</li> <li>• Key outside extends/retracts deadbolt</li> <li>• Rigid outside lever</li> <li>• Thumbturn inside extends/retracts deadbolt</li> <li>• Rotating inside lever retracts deadbolt and latchbolt simultaneously</li> <li>• Inside lever is always free for immediate egress</li> <li>• Indicator, outside — (VACANT/OCCUPIED)</li> </ul>	—
Privacy w/Indicator	MR 269		<ul style="list-style-type: none"> <li>• Latchbolt operated by lever from either side</li> <li>• Key outside extends/retracts deadbolt</li> <li>• Thumbturn inside extends/retracts deadbolt</li> <li>• Inside lever simultaneously retracts latchbolt and deadbolt</li> <li>• Indicator, outside — (VACANT/OCCUPIED)</li> </ul>	
Privacy w/Indicator	MR276		<ul style="list-style-type: none"> <li>• Latchbolt operated by lever from either side</li> <li>• Emergency coin turn outside unlocks outside lever</li> <li>• Thumbturn inside locks/unlocks outside lever</li> <li>• Closing door unlocks outside lever</li> <li>• Rotating inside lever unlocks outside lever</li> <li>• Indicator, outside — (VACANT/OCCUPIED)</li> </ul>	F22 w/Indicator
Privacy with Deadbolt w/Indicator	MR278		<ul style="list-style-type: none"> <li>• Latchbolt operated by lever from either side</li> <li>• Emergency coin turn outside retracts deadbolt</li> <li>• Thumbturn inside extends/retracts deadbolt</li> <li>• Indicator, outside — (VACANT/OCCUPIED)</li> </ul>	F02 w/Indicator
Privacy with Deadbolt and Egress w/Indicator	MR279		<ul style="list-style-type: none"> <li>• Latchbolt operated by lever from either side</li> <li>• Emergency coin turn outside retracts deadbolt</li> <li>• Thumbturn inside extends/retracts deadbolt</li> <li>• Inside lever simultaneously retracts latchbolt and deadbolt</li> <li>• Indicator, outside — (VACANT/OCCUPIED)</li> </ul>	F19 w/Indicator



Notes: Functions MR257, MR259 and MR260 not available in 7 Pin SFIC or LFIC.



### PDQ Functions – Deadlocks

FUNCTION	FUNCTION NUMBER	OUTSIDE   INSIDE	DESCRIPTION	ANSI NUMBER
Single Cylinder Deadbolt	MR131		<ul style="list-style-type: none"> <li>• Key outside extends/retracts deadbolt</li> </ul>	F18
Cylinder and Thumbturn Deadbolt	MR132		<ul style="list-style-type: none"> <li>• Key outside extends/retracts deadbolt</li> <li>• Thumbturn inside extends/retracts deadbolt</li> </ul>	F17
Double Cylinder Deadbolt	MR133		<ul style="list-style-type: none"> <li>• Key outside extends/retracts deadbolt</li> <li>• Key inside extends/retracts deadbolt</li> </ul>	F16
Classroom Deadbolt	MR134		<ul style="list-style-type: none"> <li>• Key outside extends/retracts deadbolt</li> <li>• Inside cylinder turn retracts but does not extend deadbolt</li> <li>• Not field reversible</li> <li>• Specify handing</li> </ul> 	F29
Single Cylinder Deadbolt w/Indicator (Privacy)	MR232		<ul style="list-style-type: none"> <li>• Key outside extends/retracts deadbolt</li> <li>• Thumb turn inside extends/retracts deadbolt</li> <li>• Indicator outside displays:                             <ul style="list-style-type: none"> <li>• Occupied when deadbolt is projected</li> <li>• Vacant when deadbolt is retracted</li> </ul> </li> <li>• Indicator, outside — (VACANT/OCCUPIED)</li> </ul>	—

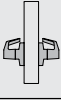
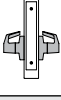
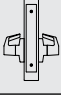
### PDQ Functions – Non Keyed Dummy

FUNCTION	FUNCTION NUMBER	OUTSIDE   INSIDE	DESCRIPTION	ANSI NUMBER
Double Dummy	MR205		<ul style="list-style-type: none"> <li>• Rigid outside lever</li> <li>• Rigid inside lever</li> </ul>	—
Double Dummy with Chassis	MR206		<ul style="list-style-type: none"> <li>• Rigid outside lever</li> <li>• Rigid inside lever</li> </ul>	—
Double Dummy with Active Trim	MR207		<ul style="list-style-type: none"> <li>• Movable outside lever</li> <li>• Movable inside lever</li> </ul>	—
Single Dummy	MR211		<ul style="list-style-type: none"> <li>• Rigid outside lever</li> </ul>	—
Single Dummy with Chassis	MR212		<ul style="list-style-type: none"> <li>• Rigid outside lever</li> </ul>	—



## Function Cross Reference

ANSI #	PDQ FUNCTION	ARROW	BEST	CORBIN	DORMA	FALCON	MARKS	SARGENT	SCHLAGE	ACCENTRA
DUMMY 1 SIDE	MR211	BM/AM08	45H1DT	ML2050	M9001	MA12	DI/DO	8293	L0170	AU865
DUMMY 2 SIDES	MR207	BM/AM09	45H2DT	ML2071	M9002	MA18	DT	8294	L0172	AU838A
DUMMY 1 SIDE	MR212	N/A	N/A	N/A	M9003	N/A	N/A	N/A	L9175	N/A
DUMMY 2 SIDES	MR206	N/A	N/A	N/A	M9004	N/A	N/A	N/A	L9176	N/A
F01	MR126	BM/AM01	45HN	ML2071	M9010	MA101	5N	8215	L9010	AU8801FL
F31	SEE TJ SE-RIES	BM/AM07	45HNX	N/A	M9025	MA161	5EX	N/A	N/A	AU8828
F22	MR176	BM/AM26	45HLT	ML2060	M9040	MA321	5LJ	8265	L9040	AU8862FL
F04	MR116	BM/AM22	45HA	ML2051	M9050	MA521	5E	8205	L9050	AU8807FL
F09	MR186	BM/AM32	45HC	ML2042	M9060	MA381	5G	8216	L9060	AU8817-2FL
	MR148	BM/AM17	45HR	ML2055	M9070	MA561	5J	8237	L9070	AU8808FL
F06	MR113	N/A	45HR/HB	ML2056	M9076	MA551	5JM/JR	8289	L9076	AU8800
F07	MR115	BM/AM12	45HD	ML2057	M9080	MA581	5EW	8204	L9080	AU8805FL
	MR199A	BM/AM17/177	45HEL	ML22901	M9080EL	MA851	5EL	8270	L9080EL	AU8890FL
	MR199A	BM/AM17/178	45HEU	ML22904	M9080EU	MA881	5EU	8270	L9080EU	AU8891FL
	MR199A W/ REX	N/A	45HEURQE	ML22901 M92	M9080ELRX	N/A	5EL W10	RX-8272	L9080ELRX	AU8890FL-REX
	MR199A W/ REX	N/A	45HEURQE	ML22904 M92	M9080ELRX	N/A	5EU W10	RX-8273	L9080EU-RX	AU8891FL-REX
F30	MR138	BM/AM33	45HW	ML2032	M9082	MA411	5WW	N/A	L9082	AU8830-2FL
F19	MR179	BM/AM02	45HL	ML2030	M9940	MA311	5LF	8266	L9440	AU8802FL
F20	MR162	BM/AM20	45HAB	ML2067	M9953	MA531	5FD	8243	L9453	AU8847FL
F13	MR136	BM/AM19	45HT	ML2065	M9956	MA571	5FW	8225	L9456	AU8822FL
F11	MR158	N/A	N/A	N/A	M9957	N/A	5FA	N/A	N/A	AU8800
F17	MR132	BM41	45HAD	ML2013	N/A	M941	5P	8221	L9460	AU8815
F18	MR131	BM40	45HYB	NML2011	N/A	MA921	5S	8220	L9464	AU8814
F16	MR133	BM42	45HWD	ML2012	N/A	M931	5T	8222	L9462	AU8814-2
F29	MR134	BM44	45HRD	ML2017	MB9963	M911	5SC	8203	L9463	AU8813ST
F14	MR137	BM/A/31	45HG	ML2017	M9966	MA371	5C	8226	L9466	AU8860-2FL
F34	MR157	N/A	45HIDA	ML2023	M9967	MA431	5FC	8240	N/A	AU8812-2FL
F33	MR159	N/A	45HIND	N/A	M9968	N/A	5FX	N/A	L9457	AU8811-2FL
F21	MR135	BM/AM13	45HB	ML2024	M9973	MA541	5B	8224	L9473	AU8860FL
F02	MR178	N/A	N/A	ML2020	N/A	MA301	5-55L	8268	N/A	N/A

## Lever Cross Reference

LEVER AND KNOB OPTIONS	PDQ	ARROW	BEST	CORBIN	DORMA	FALCON	MARKS	SARGENT	SCHLAGE	ACCENTRA
LEVER	PHILADELPHIA	X	15	NS NEWPORT	LR	D DANE	AMERICAN LEVER 92	L	06 RHODES	AU AUGUSTA
	BOSTON	BR	14	PS PRINCETON	LC	Q QUANTUM	CRESCENT LEVER 86	P	17SPARTA	PB PACIFIC BEACH
	CHICAGO	N	12	REGIS	LIIO	N/A	OMNI 78	W	02	PINEHURST PNR
	DALLAS	HS	3	LS LUSTR	LT	K KIM	PLAZA LEVER 82	J	03TUBULAR	CR CARMEL
	HOUSTON	N/A	79	25M PIET	N/A	N/A	N/A	REM	M51	N/A
	MIAMI	V	16	AS ARMSTONG	LG	A AVALON	TITAN LEVER 96	B	07ATHENS	JN JEFFERSON
	MEMPHIS	W	69	DIRKE	LD	N/A	DAYTON 83	A	12	VICTORIA TT
	LOS ANGELES	N/A	N/A	N/A	N/A	N/A	N/A	N/A	N/A	N/A
	ORLANDO	N/A	N/A	N/A	N/A	N/A	N/A	N/A	LATITUDE	N/A
KNOB	KNOB	HB	4	YW	KB	T TROY	ROUND KNOB 10	C	41 PLYMOUTH	LF LITCHFIELD
	B	HT	N/A	GR	KB	H HANA	ROUND KNOB 10	B	42 ORBIT	CA CAROLINA
	N/A	A	R	F	KB	G GALA	RW	N/A	B	R

Information on this sheet is compiled from public documents and third parties. As a result, PDQ makes no guarantees as to their accuracy, content, quality or availability. Comparisons were made using the technical features only and are not commercial comparisons. Final suitability should be determined by a professional hardware consultant.



# MR SERIES

## LIST PRICE

Effective July 3, 2023

### F Series Sectional Trim

- Levers: Solid Forged Brass
- Trim: Wrought

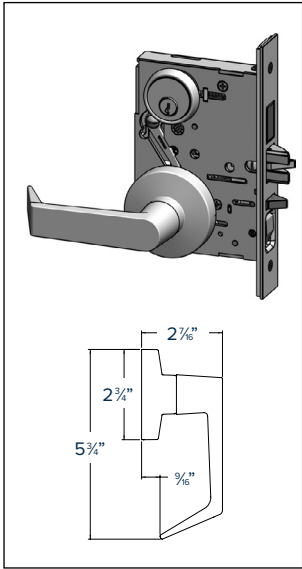

PHILADELPHIA — PFSF

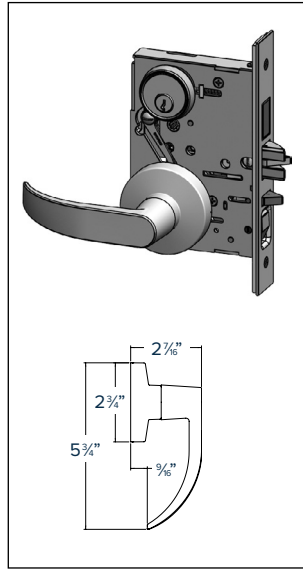

BOSTON — BFSF

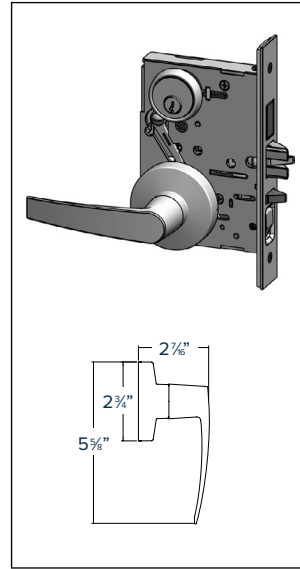

MIAMI — MFSF

### F Series Escutcheon Trim

- Levers: Solid Forged Brass
- Trim: Forged Brass

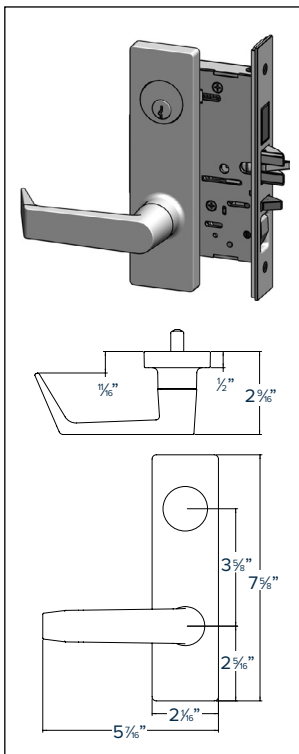

PHILADELPHIA — PFEF

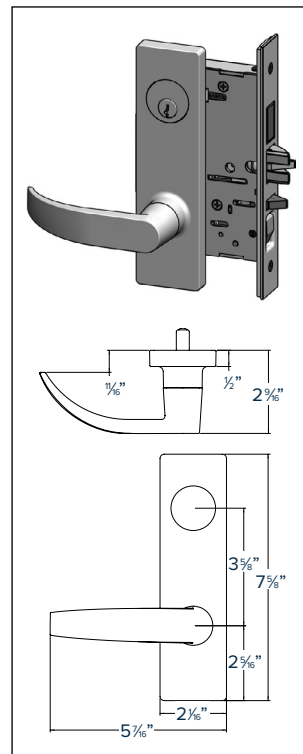

BOSTON — BFEF

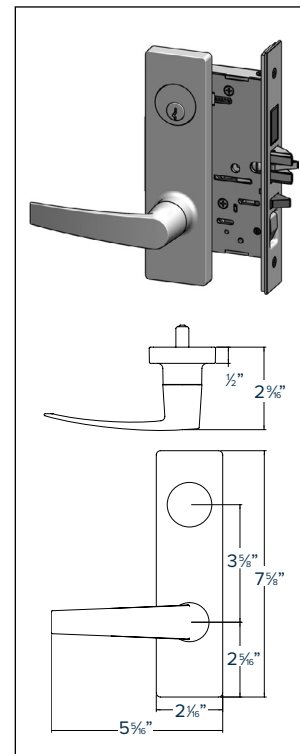

MIAMI — MFEF



\*Knobs are not ADA Compliant

## J Series Sectional Trim with Round Rose

- Levers: Philadelphia, Boston, Miami, Memphis, Houston – Solid Levers  
Chicago, Dallas, Los Angeles, Orlando – Hollow Tube Levers
- Trim: Wrought

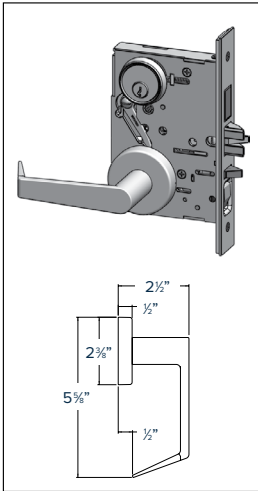

PHILADELPHIA —  
PJSJ

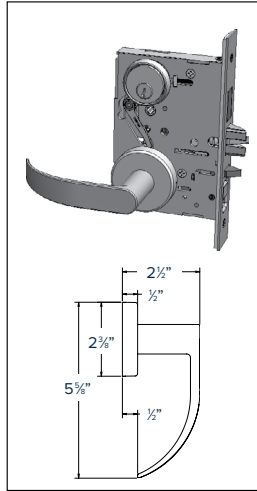

BOSTON — BJSJ

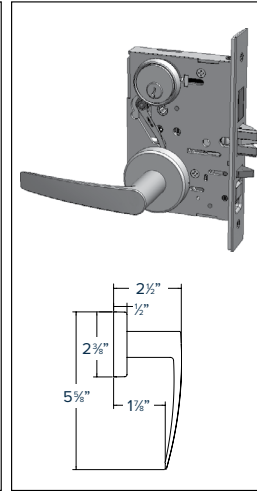

MIAMI — MJSJ

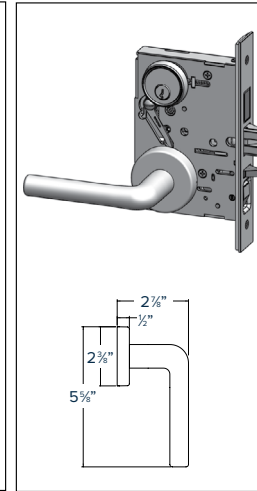

CHICAGO — CJSJ

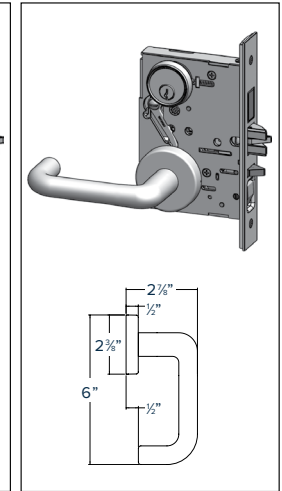

DALLAS — DJSJ

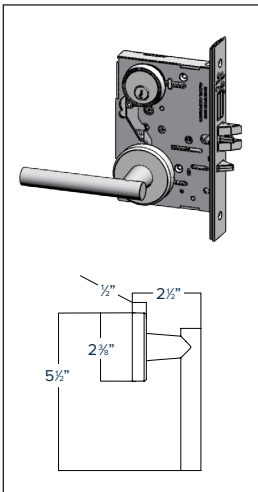

HOUSTON — HJSJ

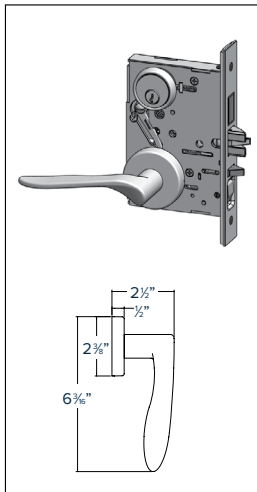

MEMPHIS — TJSJ

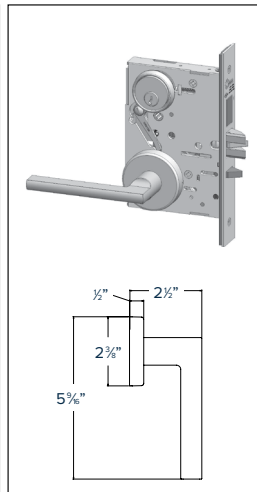

ORLANDO — OJSJ

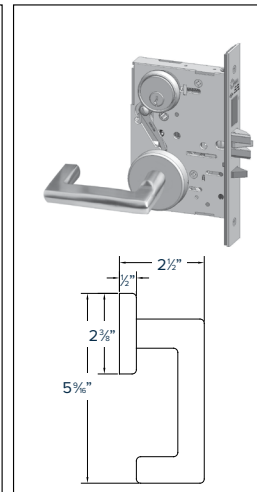

LOS ANGELES —  
LJSJ

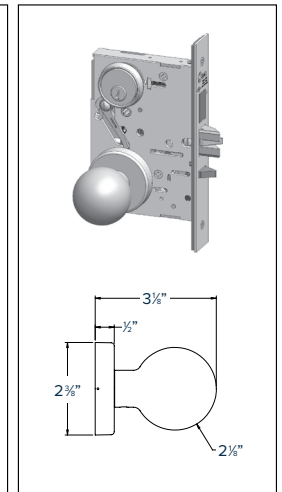

BALL KNOB — KJSJ



\*Knobs are not ADA Compliant

# MR SERIES

# LIST PRICE

Effective July 3, 2023

## J Series Sectional Trim with Square Rose

- Levers: Philadelphia, Boston, Miami, Memphis, Houston – Solid Levers  
Chicago, Dallas, Los Angeles, Orlando – Hollow Tube Levers
- Trim: Wrought

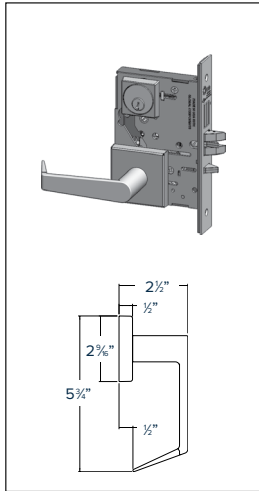

PHILADELPHIA —  
PJSR

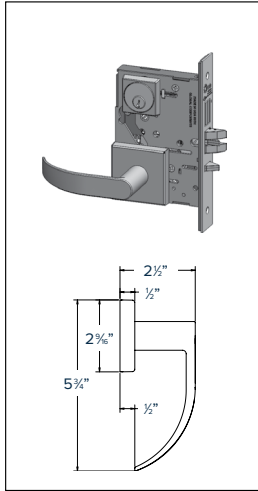

BOSTON — BJSR

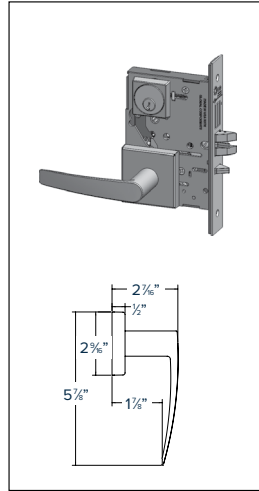

MIAMI — MJSR

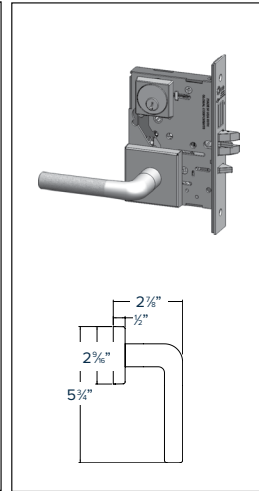

CHICAGO — CJSR

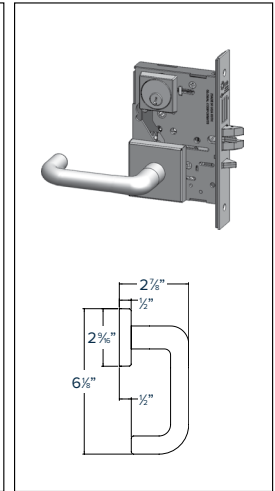

DALLAS — DJSR

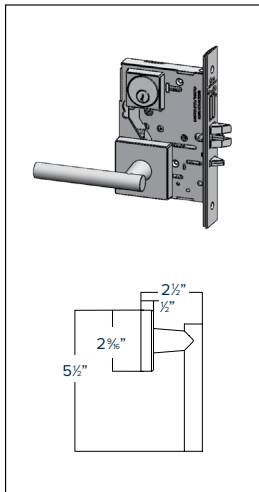

HOUSTON — HJSR

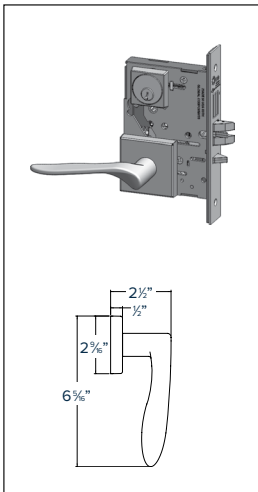

MEMPHIS — TJSR

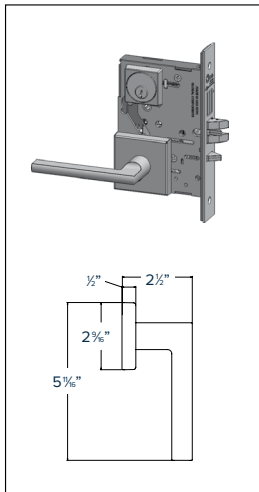

ORLANDO — OJSR

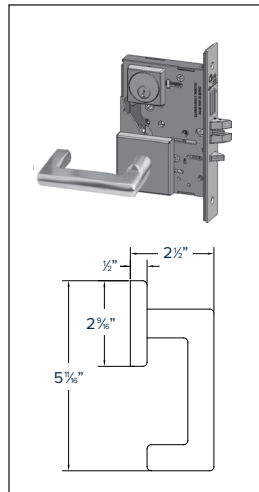

LOS ANGELES —  
LJSR

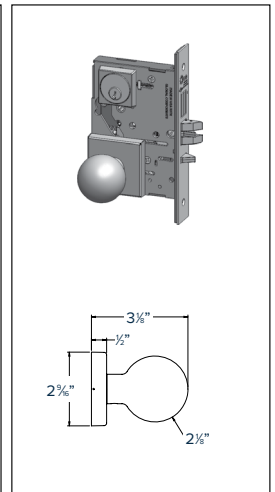

BALL KNOB — KJSJ

ALL LEVERS

\*Knobs are not ADA Compliant

## J Series Escutcheon Trim

- Levers: Philadelphia, Boston, Miami, Memphis, Houston – Solid Levers
- Chicago, Dallas, Los Angeles, Orlando – Hollow Tube Levers
- Trim: Investment Cast Stainless

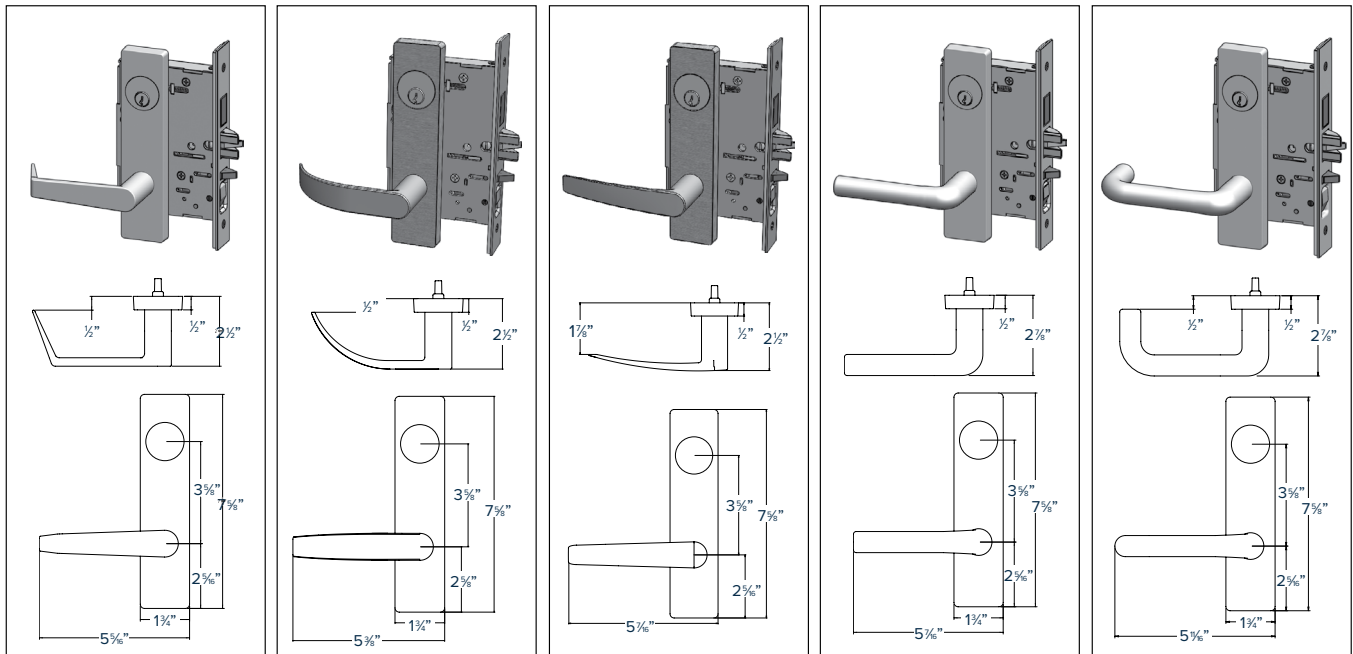

PHILADELPHIA — PJEJ

BOSTON — BJEJ

MIAMI — MJEJ

CHICAGO — CJEJ

DALLAS — DJEJ

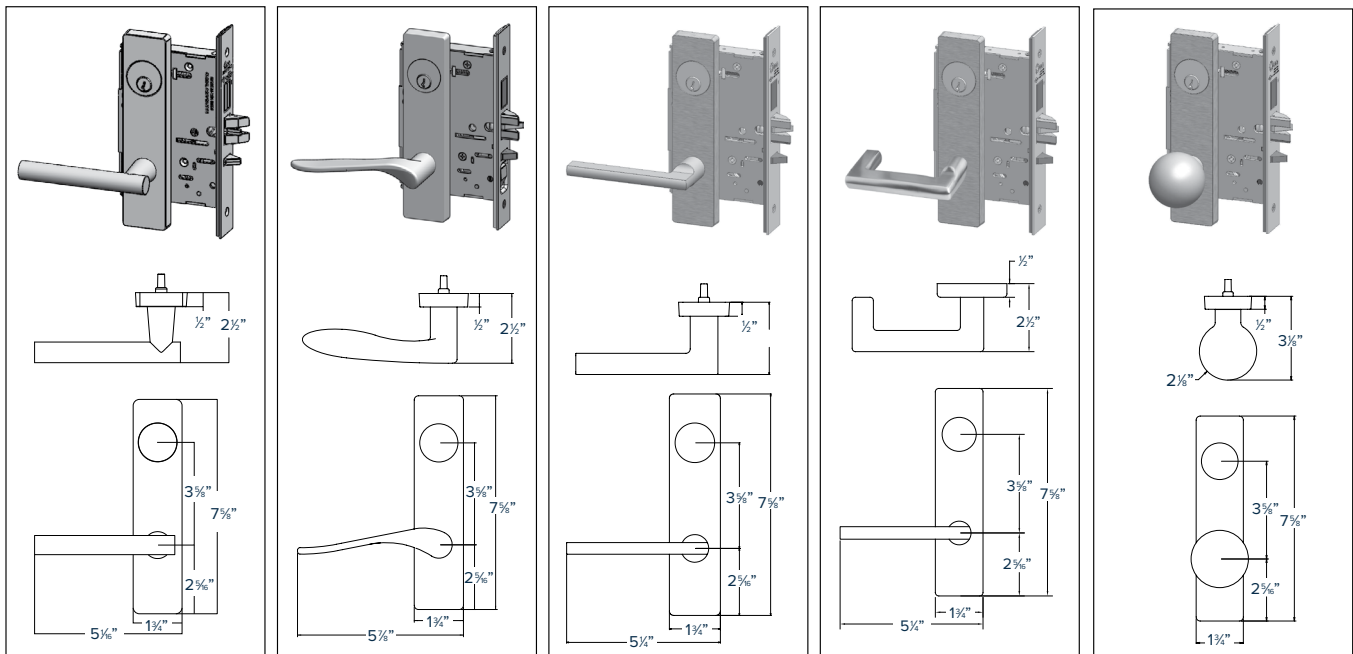

HOUSTON — HJEJ

MEMPHIS — TJEJ

ORLANDO — OJEJ

LOS ANGELES — LJEJ

BALL KNOB — KJEJ



\*Knobs are not ADA Compliant

# MR SERIES

# LIST PRICE

Effective July 3, 2023

## J Series Wide Escutcheon Trim

- Levers: Philadelphia, Boston, Miami, Memphis, Houston – Solid Levers
- Chicago, Dallas, Los Angeles, Orlando – Hollow Tube Levers
- Trim: Investment Cast Stainless

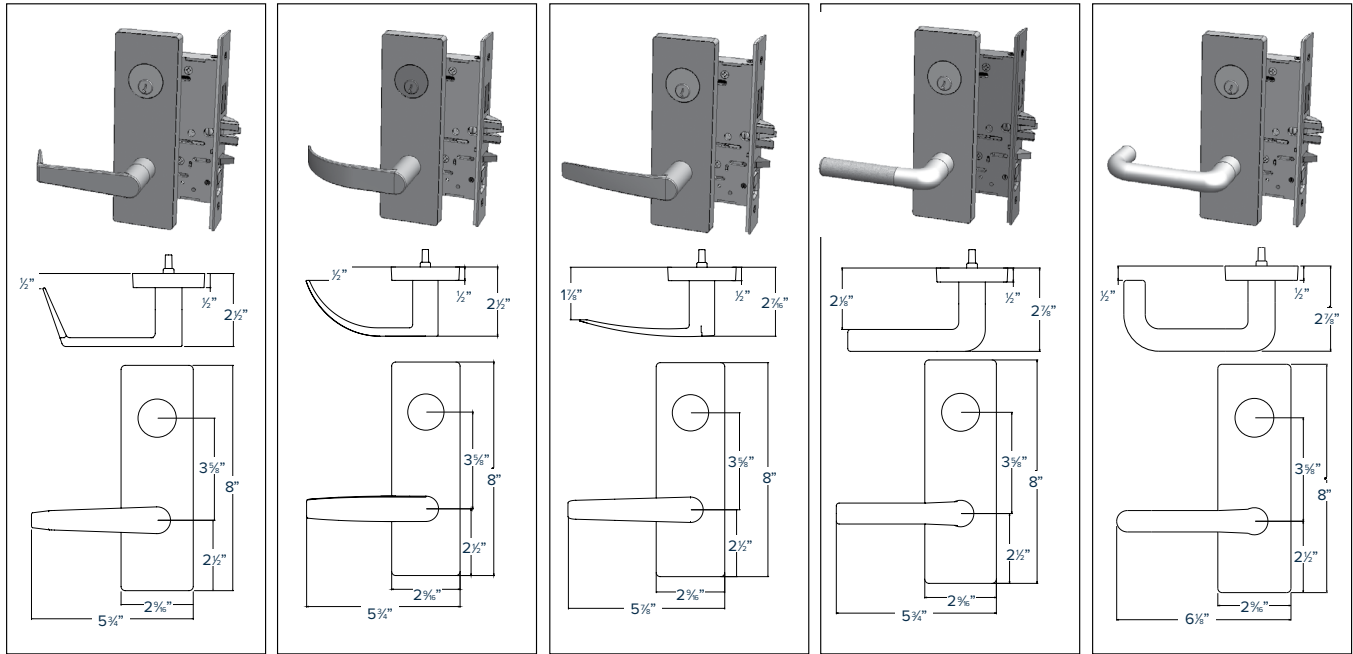

PHILADELPHIA — PJEW

BOSTON — BJEW

MIAMI — MJEW

CHICAGO — CJEW

DALLAS — DJEW

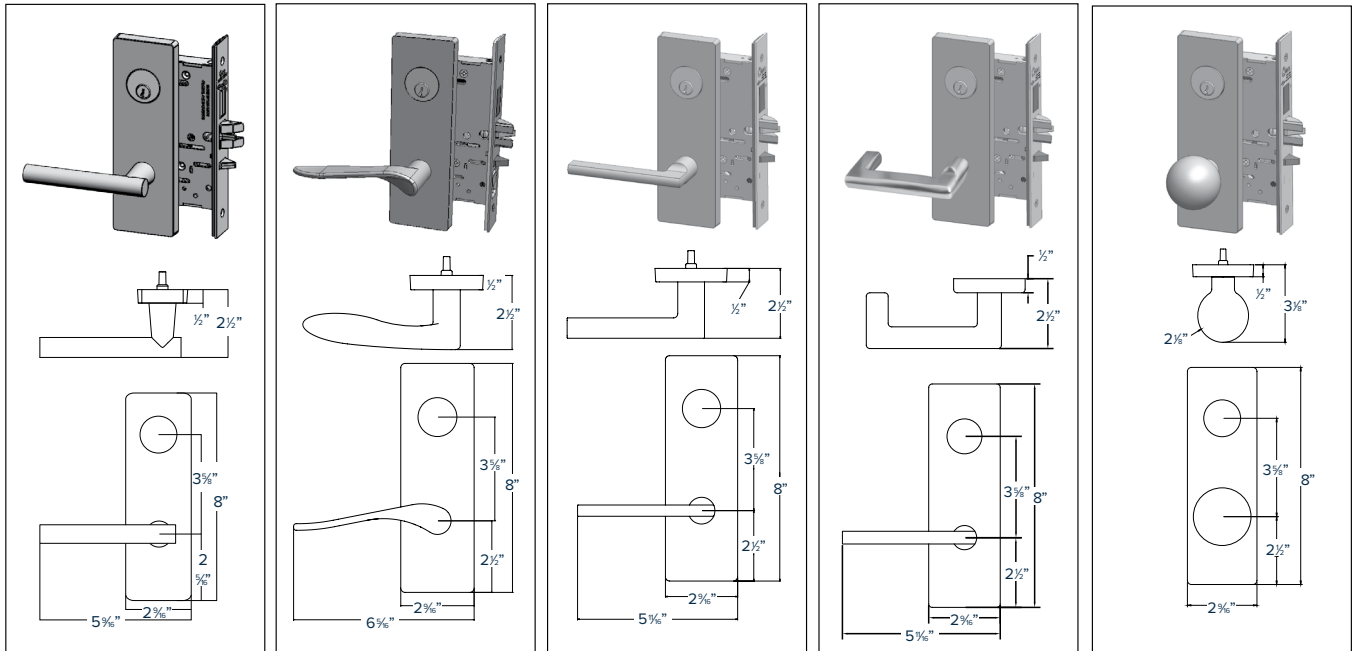

HOUSTON — HJEW

MEMPHIS — TJEW

ORLANDO — OJEW)

LOS ANGELES — LJEW

BALL KNOB — KJEW

ALL LEVERS

\*Knobs are not ADA Compliant

## Typical Applications

- High-End Residential
- Multi-family
- Offices

## Features

- Contemporary decorative trim perfect for high end residential and office work
- Designed to compliment MR Series Mortise locks sharing the same sectional rose diameter and levers
- Investment cast stainless steel trim
- Range of lever styles available
- Available in round rose or square rose
- Uses a slender 2-3/8" diameter rose providing a clean contemporary look

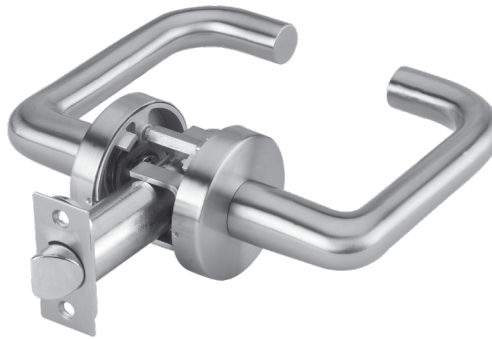

Round Rose Trim  
with Dallas Lever



Square Rose Trim  
with Orlando Lever

## Specifications



<b>FOR DOORS:</b>	• For doors 1-3/8" (35mm) to 1-3/4" (44mm) thick standard
<b>BACKSET:</b>	• 2-3/4" (70mm) default. Optional: 2-3/8" (60mm);
<b>STRIKE:</b>	• "Full Lip" strike default. "T" strike and ASA strike optional
<b>ROSE DIMENSIONS:</b>	• Round Rose: 2-3/8" DIA • Square Rose: 2-9/16"
<b>DOOR PREP:</b>	• ANSI Standard 115.2, Type 161 for 2-3/4" Backset • Type 160 optional
<b>LATCH BOLTS:</b>	• 2-3/4" Backset has 1-1/8" faceplate. 2-3/8" Backset has a 1" faceplate filler
<b>HAND:</b>	• Non-handed, except Memphis. (Orlando, Los Angeles, Houston is handed for 211 function only)
<b>FINISHES:</b>	• 605 (US3) Bright Brass, 606 (US4) Satin Brass, 612 (US10) Satin Bronze, 613E Dark Oxidized Satin Bronze (Equivalent), 622 (US19) Flat Black, 629 (US32) Bright Stainless Steel, 630 (US32D) Satin Stainless Steel
<b>TRIM:</b>	• Stainless Steel Levers and Roses
<b>LEVER DESIGNS:</b>	• Philadelphia, Boston, Miami, Chicago, Houston, Memphis, Orlando, Los Angeles, Dallas and Ball Knob.
<b>CERTIFICATIONS, LISTINGS, COMPLIANCES:</b>	• Complies with ADA (Americans with Disabilities Act) and ICC/ANSI 117.1 for Accessible and Usable Buildings (except ball knob).
<b>WARRANTY:</b>	• Five (5) year limited warranty

## How to Order

TJ SERIES  
TUBULAR LOCKS

QUANTITY	SERIES	FUNCTION	LEVER	ROSE	FINISH	BACKSET	HANDING	STRIKE
5	TJ	176	PHL	—	630	234	—	FL
			PHL	<b>BLANK</b> – Round Rose (Default) <b>SR</b> – Square Rose	605	<b>234</b> – 2-3/4" Default <b>238</b> – 2-3/8" Optional	<b>LH</b> – Left Hand <b>RH</b> – Right Hand	<b>FL</b> – Full Lip Strike (Default) <b>T</b> – 'T' Strike <b>ASA</b> – ANSI/ ASA Strike
			BSN		606			
			MIA		612			
			CHI		613E			
			DAL		622			
			MEM		629			
			ORL		630			
			HOU					
			LAX					
			KJ					

## TJ Series

ANSI NO.	FUNCTION	DESCRIPTION	SECTIONAL	
			630	605, 606, 612 613E, 622, 629
	125	Communicating	\$130.00	\$155.00
F75	126	Passage	\$180.00	\$205.00
F76	176	Privacy	\$180.00	\$205.00
	205	Double Dummy	\$130.00	\$155.00
	211	Single Dummy	\$100.00	\$112.00

## Rose Option

CODE	DESCRIPTION	LOCK ADJUSTMENT
—	Round Rose	N/C
SR	Square Rose	\$10.00

## Lever / Round Rose



PHILADELPHIA — PHL

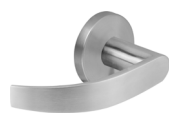

BOSTON — BSN



MIAMI — MIA



CHICAGO — CHI



DALLAS — DAL



MEMPHIS — MEM  
 (Specify handing)



ORLANDO — ORL  
 (Specify handing)



LOS ANGELES — LAX  
 (Specify handing)



HOUSTON — HOU  
 (Specify handing)



BALL KNOB — KJ



ALL LEVERS



### Lever / Square Rose



PHILADELPHIA — PHL



BOSTON — BSN



MIAMI — MIA



CHICAGO — CHI



DALLAS — DAL



MEMPHIS — MEM  
 (Specify handing)



ORLANDO — ORL  
 (Specify handing)



LOS ANGELES — LAX  
 (Specify handing)



HOUSTON — HOU  
 (Specify handing)





BALL KNOB — KJ

 **ALL LEVERS**

## PDQ Functions

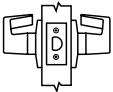
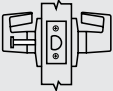
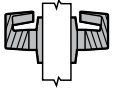
TJ SERIES  
TUBULAR LOCKS

FUNCTION	FUNCTION NUMBER	INSIDE   OUTSIDE	DESCRIPTION	ANSI NUMBER
<b>NON KEYED</b>				
Communicating	125		<ul style="list-style-type: none"> <li>Latchbolt operated by lever from inside</li> <li>Non removable blank outside</li> </ul>	—
Passage Closet	126		<ul style="list-style-type: none"> <li>Latchbolt operated by lever from either side</li> </ul>	F75
Privacy Bedroom/Bathroom	176		<ul style="list-style-type: none"> <li>Latchbolt operated by lever from either side</li> <li>Outside lever locked by push button on inside</li> <li>Outside lever unlocked by emergency release from outside, rotating inside lever, or closing door</li> </ul>	F76
Double Dummy	205		<ul style="list-style-type: none"> <li>Rigid lever both sides</li> <li>No mechanical operation</li> </ul>	—
Single Dummy	211		<ul style="list-style-type: none"> <li>Rigid lever outside</li> <li>No mechanical operation</li> </ul>	—



INDICATES RIGID LEVER



# Heavy Duty Grade 1 Cylindrical Locks



ASSEMBLED  
IN THE USA

## More Duty Than You Can Handle

Most manufacturers' approach to lock design ends with simply meeting BHMA/ANSI standards but not PDQ. Our philosophy is to step out of the box and develop innovative designs that take our locks to the next level. We don't just meet the standard, we crush it. Our design doctrine delivers the confidence that locks are built to last, whether the application calls for resistance to high abuse or to millions of cycles of operation without any degradation in performance

---

### XGT/GT Mechanical

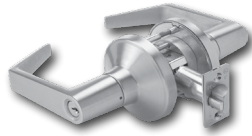

#### Applications

High traffic doors, areas subject to severe abuse, K-12, higher education, Healthcare, public buildings and retro-fit applications.

---

### XGT/GT199A Electro-Mechanical

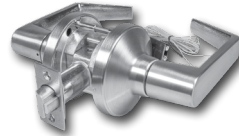

#### Applications

Stairwell towers, tenant spaces, pharmacies, computer rooms and high security areas.

---

### XGT/GT135LED School Security Solution



#### Applications

In K-12 and higher education, indicators are part of the overall security plan. The GT135LED Classroom Intruder lock is designed to allow a staff member to use the inside cylinder to lock the outside of the door. The Intruder function eliminates the need to open the door to check for a locked lever. Simply press the button on the lock and if the red LED lights up the outside lever in locked and secure. If the LED does not light up, the outside lever is unlocked.

---

### SX Ball Knob

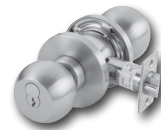

#### Applications

High traffic areas, Healthcare and commercial buildings.



# XGT/ GT199A

## Electrified Cylindrical Lock Grade 1 Heavy Duty



ASSEMBLED  
IN THE USA

### Typical Applications

- Computer Rooms
- High Security Areas
- Pharmacies
- Stairwell Towers
- Tenant Spaces

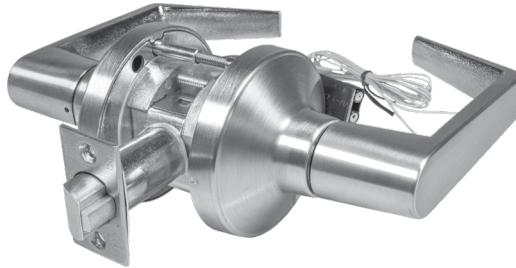

### Specifications



<b>PERFORMANCE:</b>	<ul style="list-style-type: none"> <li>• Motor drive factory tested to over 1.4 million cycles (nearly 3x the ANSI/BHMA Grade 1 Standard).</li> </ul>
<b>RECOMMENDED POWER SUPPLY:</b>	<ul style="list-style-type: none"> <li>• PDQ Model # PS220.                             <ul style="list-style-type: none"> <li>– Input: 110-120 VAC 60Hz</li> <li>– Output: 24VDC, 2A, filtered and regulated.</li> </ul> </li> <li>• Rated for simultaneous operation of 2ea mortise lock assemblies.</li> <li>• Power Supply Requirements:                             <ul style="list-style-type: none"> <li>– AC/DC Output Voltage</li> <li>– 1A min (filtered and regulated).</li> </ul> </li> </ul>
<b>ELECTRICAL SPECIFICATIONS:</b>	<ul style="list-style-type: none"> <li>• Input voltage: 12-24VDC or 12-24VAC.</li> <li>• Max In-rush current: 1.0A.</li> <li>• Standby current:                             <ul style="list-style-type: none"> <li>– 12VAC: 12mA.</li> <li>– 24VAC: 10mA.</li> <li>– 12VDC: 3mA.</li> <li>– 24VDC: 5mA.</li> </ul> </li> <li>• 12-24VDC @ &lt; 1A initial surge (1 sec), 5mA standby after 30 sec.                             <ul style="list-style-type: none"> <li>– AC Output Voltage.</li> </ul> </li> <li>• 12-24VAC (60Hz) @ &lt; 1A initial surge (1 sec), 15mA standby after 30 sec</li> </ul> <p>Note: Operating voltage at ± 10% of rated voltage.</p>
<b>CERTIFICATIONS, LISTINGS, COMPLIANCES:</b>	<ul style="list-style-type: none"> <li>• ANSI/UL10C and CAN/ULC-5104 Listed for "Fire Exit Hardware" up to 3 hours for 4'0" x 8'0" maximum single, 8'0" x 8'0" maximum pairs.</li> <li>• Assembled in the U.S.A. with U.S. and foreign material. Meets requirements of the Buy American Act as a COTS product manufactured in the United States.</li> </ul>
<b>WARRANTY:</b>	<ul style="list-style-type: none"> <li>• 25-Years Mechanical / 2-Years Electronic</li> </ul>

### Trim/Levers



PHILADELPHIA — PHL



SFL



LFL



BOSTON — BSN



SFL



MIAMI — MIA



SFL

# XGT/GT135 LED

# School Security Solutions



ASSEMBLED  
IN THE USA



Outside Lever Unlocked



To Check the Security of the Outside Lever, Press the Button. If the Red Led Lights Up, that Confirms the Outside Lever is Locked and Secure.

## Easy-to-Read LED Indicator Confirms the Door is Locked.

XGT/GT 135 LED Classroom Intruder Cylindrical Lock is designed to allow a staff member to use the inside cylinder to lock the outside of the door, without compromising safety to the occupants in the room. But how does a staff member know if the outside lever is locked?



Until now, it required opening the door and checking the lever. PDQ's 135 LED Classroom Intruder function eliminates the need to open the door. Simply press the button on the lock, and...if the Red LED lights up, the outside lever is locked and secure. If the Red LED does not light up, this indicates the outside lever is not locked and secure.

## Features



- Complies with California Education Code (Functions GT135, GT135LED, GT145)
- Red LED (Light Emitting Diode) outside lever status indicator.
- Pushing the button located on the rose of the inside lock, Red LED illuminates indicating the outside lever is locked.
- Offered with cylinder housings compatible with Best® Small Format Inter-changeable cores, Schlage® Large Format Interchangeable cores and most others.
- Large Format Inter-changeable cores only available with PHL lever.
- Keying options available, compatible with most key systems.
- Battery life rating: 10 years\*
- Battery type: CR1220
- Patented (US Patent #9,187,928)
- Factory tested to over 2 million cycles (2 times the ANSI/BHMA Grade 1 std)
- Lever torque tested to 2,100 in-lbs (3 times the ANSI/BHMA Grade 1 std)

## Status Indicator Locks

GT135LED  
GT135  
GT145

## Time Out Locks

GT173

## School Security Functions

Vestibule Class Room Security with LED Status Indicator

Vestibule Class Room Security without LED Status Indicator

Vestibule Class Room Security with Lock Directional Arrow (No LED Indicator)

Time Out Lock



ASSEMBLED  
IN THE USA

## Typical Applications

- Federal and State Government
- Healthcare
- Higher Education
- Hospitality
- Houses of Worship
- Industrial
- K-12 Education
- Offices
- Public Buildings

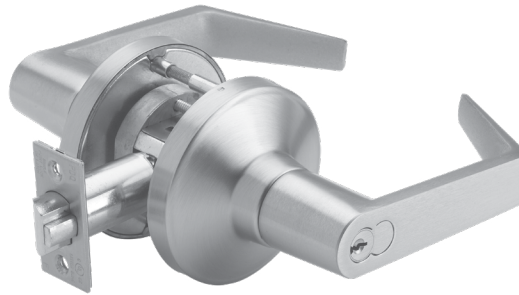

## Specifications



<b>FOR DOORS:</b>	• 1-3/4" to 2-1/4" thick • Preset for 1-3/4" door
<b>APPLICATION:</b>	• Through door thru-bolting
<b>DOOR PREP:</b>	• Standard ANSI A156.115 (161) for Cylindrical Locks
<b>BACKSET:</b>	• 2-3/4" Standard. 2-3/4"FF, 3-3/4" and 5" Optional (Ordered from factory only). • Heavy duty diecast, investment cast, chromated cold rolled steel and stainless steel mechanism. • Billet Steel spindles for locking functions
<b>FRONT:</b>	• 2-1/4" x 1-1/8" • Stainless Steel or Wrought Brass • Beveled 1/8" in 2"
<b>STRIKE</b>	• ASA standard • T-Strike or Full Lip Strike optional • Stainless Steel or Wrought Brass
<b>LEVERS:</b>	• Philadelphia (SFL and LFL), Boston (SFL), Miami (SFL)
<b>ROSE:</b>	• 3-3/8" DIA Wrought
<b>LATCHBOLT:</b>	• 9/16" Throw Deadlocking
<b>HAND:</b>	• Non-handed
<b>TRIM:</b>	• Solid diecast PHL, BSN or MIA Levers • 41° Lever Rotation Standard with 2-3/4" Backset • Wrought Brass Roses, Concealed Screws • 65° Lever Rotation Standard with 3/4" latch for double doors (Ordered from factory only) and all 2-3/8", 3-3/4" and 5" Backsets (Ordered from factory only)
<b>KEYS:</b>	• Two (2) per Lock
<b>KEYWAYS</b>	• SCC standard (Schlage C Compatible) • Also available in keyways of other manufacturers
<b>INTERCHANGEABLE CORE:</b>	• Available for all keyed functions • 6 or 7-pin • Large Format IC Core available for PHL Lever ONLY. • Compatible with Best, Falcon and Arrow small format IC cores
<b>CYLINDER:</b>	• 6-pin Brass Insert Cylinder keyed to 5-pins • Standard High Security and UL437 Cylinders Available
<b>KEYING:</b>	• Options: MK, CMK or GMK • Zero Bitted (KO), Keyed Different (KD) or Keyed Alike (KA) Can be keyed into existing master key systems
<b>FINISHES:</b>	• 605 (US3), 606 (US4), 612 (US10), 613E , 619 (US15), 622 (US19), 625 (US26), 626 (US26D) • Optional Antimicrobial Coating 626 (USD26D) only†
<b>CERTIFICATIONS, LISTINGS, COMPLIANCES:</b>	• UL listed for 3 hrs, for single doors up to 4'0" x 8'0" • Certified to ANSI/BHMA A156.2, Grade 1 • California Education Code Compliant (Functions XGT135, XGT135LED, XGT145) • Federal Specification FF-H-10C (Superseded by A156.2) • Approved for Florida HVHZ (High Velocity Hurricane Zone). PDQ Product Approval: FL 21376. • Design load rating: ± 70.0 PSF for single door (3' x 7') • Complies with ADA (Americans with Disabilities Act) and ICC/ANSI 117.1 for Accessible and Usable Buildings
<b>WARRANTY:</b>	• Limited Lifetime Warranty
<b>COUNTRY OF ORIGIN:</b>	• Proudly Assembled in the U.S.A. with U.S. and foreign material. Meets requirements of the Buy American Act as a COTS product manufactured in the United States.

† Available with antimicrobial powder coating, treated with silver ionic technology that is known to inhibit the growth of microbes.

# XGT SERIES

# LIST PRICE



Effective July 3, 2023

## How to Order

QUANTITY	SERIES	FUNCTION	LEVER	FINISH	BACKSET	STRIKE	CYLINDER	KEYWAY	KEYING	OPTION
6	XGT	116	PHL	626	234	ASA	D	SCC	KD	—
NOTE: Case quantity is 6/ Case weight is 33 lbs. Keyed Functions/ Case weight is 31 lbs. Non-Keyed Functions / For split finishes, designate O/S trim first, then I/S										
			BSN	605	234 —	ASA —	D Default	PAGE 39		TC1IS — Tactile Abrasive Coating - Inside only
			MIA	606	2-3/4" (default)	ASA (default)	L Less Cylinder			TC1OS — Tactile Abrasive Coating - Outside only
			PHL	612	334 —	FL —	SF6 Lock is SFIC prepped w/ 6 pin core			TC2 — Tactile Abrasive Coating - Both Sides
				613E	3-3/4"	Full Lip	SF7 Lock is SFIC prepped w/ 7 pin core			SF — Split Finishes
				619	5 — 5"	T — "T" Strike	SFL Lock is SFIC prepped but less core			LL — Lead-Lined Rose
				622			SFC Lock is SFIC prepped w/ construction core			DB — Dust Box
				625			SFP Lock is SFIC prepped w/ plastic construction core			AM — Antimicrobial Coating
				626			LF6 Lock is Schlage LFIC prepped w/ Schlage core			REX — Request to Exit
							LFL Lock is Schlage LFIC prepped but less core			ISMIC - Industry Standard Molex Connector
							LFC Lock is Schlage LFIC prepped w/ construction core			W - Weatherized (626 Only)
PAGE 38										
PAGE 40										

XGT SERIES  
CYLINDRICAL LOCKS

ANSI NO.	FUNCTION	DESCRIPTION	626	605/606/612 613E/619/622/625
<b>NON-CYLINDER</b>				
F89	124	Exit	\$373.00	\$395.00
	125	Communicating		
F75	126	Passage	\$420.00	\$442.00
	173	Time Out		
	175	Hospital / Privacy		
F76	176	Privacy	\$257.00	\$279.00
F77	177	Patio / Privacy		
	205	Double Dummy	\$175.00	\$186.00
	211	Single Dummy		
<b>SINGLE CYLINDER</b>				
F86	115	Store Room	\$484.00	\$506.00
F109	116	Entrance		
F84	148	Classroom		
	150	Exit / Twin Communicating		
F82	182	Office / Entry	\$504.00	\$526.00
	120	Security		
	129	Exit / Twin Communicating		
F92	155	Service Station	\$544.00	\$566.00
F90	165	Dormitory / Corridor		
<b>DOUBLE CYLINDER</b>				
F87	128	Institution	\$554.00	\$576.00
F110	135	Classroom / Security		
F110	135LED	Classroom/Security w/Red LED Outside Lever Status Indicator	\$723.00	\$745.00
F110	145	Classroom / Security w/Locking Direction Arrow	\$578.00	\$600.00
F91	137	Store Door		
F80	141	Communicating		
<b>ELECTRIFIED</b>				
	199A	Store Room	\$964.00	\$986.00

CYLINDER OPTIONS	ICON	LOCK ADJUSTMENT
D		
SFL		N/C
LFL*		

**IC Core not included see page 39 for core options**

**LFIC prep only available in PHL lever and 613E, 622, 626 finish.**

**NOTES:**

- Locks will be furnished with ASA Strike & SCC Keyway unless otherwise stated

## Trim/Levers



**ALL LEVERS**



PHILADELPHIA — PHL



SFL



LFL



BOSTON — BSN



SFL



MIAMI — MIA



SFL



### Backset

CODE	DESCRIPTION	LOCK ADJUSTMENT
<b>2-3/4" BACKSET</b>		
234	2-3/4" Deadlocking 2-1/4" x 1-1/8"	N/C
<b>3-3/4" BACKSET</b>		
334F	2-1/4" x 1-1/8"	\$18
334	2-1/4" x 1"	
<b>5" BACKSET</b>		
5	2-1/4" x 1-1/8"	\$24

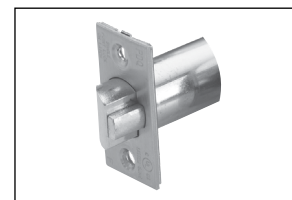

Latchbolt

### Strikes

	CODE	DESCRIPTION	LOCK ADJUSTMENT
	ASA	ASA Strike (any finish) 1-1/4" x 4-7/8"	N/C
	T	T-Strike (any finish) 1-1/8" x 2-3/4"	
	FL	Full Lip Strike (any finish) 1-5/8" x 2-1/4"	

**NOTES:**

- Specify finish for Strikes & Latchbolts if ordered separately

**NOTES:**

- Specify finish for cylinders ordered separately
- Kwikset cylinder available in 5 pin only
- Specify KD, KA4, or 1 bitted 6 pin cylinder keyed for 5 pin

### Keyways and Cylinders

PDQ KEYWAY	COMPATIBLE WITH	SOLD WITH LOCK
AR1	Arrow / AR1	N/C
CO59A1	Corbin / 59A1	
CO6	Corbin / 60	
CL4	Corbin / L4	
RUD	Russwin / D1	
SCE	Schlage / E	
SCC	Schlage / C	
SCC-K	Schlage / C-K	
SAL	Sargent / LA	
RA-RC	Sargent / RA-RC	
YA8	Yale / E1R	
GA	Yale / GA	
FAL	Falcon / E-R	
KW	Kwikset	
TA	PDQ / TA (Restricted. Limited to Grandmaster systems w/4 masters)	
Dummy	—	
T-Turn	—	
L	Less Cylinder	Deduct \$4.00
<b>HIGH SECURITY CYLINDERS AND CORES</b>		
SEE HIGH SECURITY CYLINDERS AND CORES SECTION, PAGE 118.		

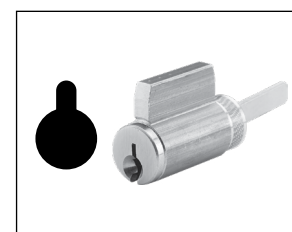

Key in Knob/Lever Cylinder



UL 437 and High Security Cylinders



### Cores and Keyways

DESCRIPTION	PDQ NO.	ADD
<b>SMALL FORMAT UNCOMBINATED</b>		
6 Pin Cores	I5206 + KEYWAY	\$40.00
7 Pin Cores	I5207 + KEYWAY	
<b>COMBINATED</b>		
6 Pin Cores	I5206-1 + KEYWAY	\$60.00
7 Pin Cores	I5207-1 + KEYWAY	
<b>BEST<sup>™</sup> Compatible</b>		
A (DEFAULT), B, C, D, E, F, G, H, J, K, L, M, Q,		
WA, WB, WC, WG, WH, TB, TD, TE, & R		
<b>PDQ Exclusive</b>		
PDQ1, PDQ2		
<b>PDQ Exclusive and Restricted</b>		
PDQ3		
<b>SFIC CONSTRUCTION</b>		
Construction Core 6-pin only		\$60.00
Dummy Construction Core Plastic		\$8.00
<b>LFIC CONSTRUCTION</b>		
Construction Core 6-pin only. <b>Construction cores are invoiced at shipment and credited upon return.</b>		\$70.00
IC Tailpiece Assembly		\$10.00
<b>LFIC COMBINATED</b>		
Schlage compatible LFIC, SCC (Schlage C compatible) keyway		\$70.00
PDQ TA LFIC Restricted		
<b>LFIC UNCOMBINATED</b>		
Schlage compatible LFIC, SCC (Schlage C compatible) keyway		\$50.00
<b>HIGH SECURITY IC CORES</b>		
SEE HIGH SECURITY CYLINDERS AND CORES SECTION, PAGE 118. — LFIC REQUIRES LARGE FORMAT LEVER		

**NOTES:**

- Specify finish for IC Cores ordered separately
- Control keys must be ordered separately
- PDQ1, PDQ2, PDQ3 (Restricted)**, Best A2 & A4 Systems Available

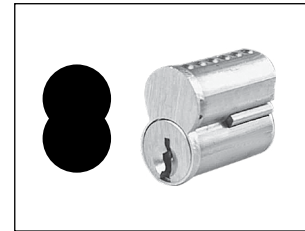

SFL/SFIC Core

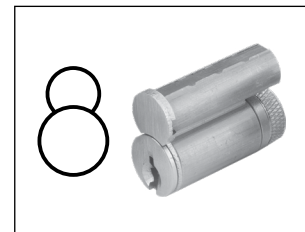

LFL/LFIC Schlage Format



UL 437 and High Security Cylinders













## Options

CODE	DESCRIPTION	LIST PRICE
<b>TC1IS</b>	Tactile Abrasive Coating - Inside only	\$26.00
<b>TC1OS</b>	Tactile Abrasive Coating - Outside only	
<b>TC2</b>	Tactile Abrasive Coating - Both Sides	\$52.00
<b>LL</b>	Lead-Lined Rose	\$214.00
<b>DB</b>	Dust Box	\$8.00
<b>AM</b>	Antimicrobial Coating, Lever Set Includes Inside and Outside Lever and Rose (Not available with 605 or 625 finish)	\$37.00
<b>REX</b>	Request to Exit	\$122.00
<b>ISMC</b>	Industry Standard Molex Connector	\$108.00
<b>W</b>	Weatherized Finish (626 Only)	\$80.00

**XGT SERIES**  
CYLINDRICAL LOCKS

# XGT SERIES PARTS

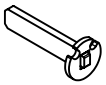
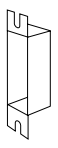
**LIST PRICE**  
Effective July 3, 2023

	DESCRIPTION	LIST PRICE	FINISHES						
			N/A	605	606	612	613E	625	626
	<b>Push Button</b> For Functions GT155, GT165, GT173, GT175, GT176, GT177, GT182	\$13	—	VA91302-5	VA91302-8	VA91302-3	VA91302-6	VA91302-2	VA91302-7
	<b>Outside Rose</b> for All Functions, Inside Rose For All functions except GT135LED, GT145	\$43	—	V32006-5	V32006-8	V32006-3	V32006-6	V32006-2	V32006-7
	<b>Inside Rose</b> w/Locking Directional Arrow For Functions GT135LED, GT145		—	VA10093-5	VA10093-8	VA10093-3	VA10093-6	VA10093-2	VA10093-7
	<b>"T" STRIKE SQUARE CORNERS</b> 1-1/8" X 2-3/4" X 3/32"	\$17	—	V919050-5	V919050-8	V919050-3	V919050-6	V919050-2	V919050-7
	<b>ASA ANSI STRIKE</b> 1-1/4" X 4-7/8" X 3/32"	\$38	—	V91905-5	V91905-8	V91905-3	V91905-6	V91905-2	V91905-7
	<b>"FULL LIP" STRIKE</b> 1-5/8" X 2-1/4" X 3/32"	\$14	—	V919051-5	V919051-8	V919051-3	V919051-6	V919051-2	V919051-7
	<b>SCREW PACK - INCLUDES MOUNTING SCREWS, HEX KEY(M5 X .8) AND PICK.</b>	\$12	—	VA10030-5	VA10030-8	VA10030-3	VA10030-6	VA10030-2	VA10030-7
	<b>SPACER</b> — For 1-3/8" doors. Sold as a pair. To be installed as a set.	\$64				V32433			
	<b>EXTENSION</b> — Converts standard latchbolt from 2-3/4" Backset to 5"	\$58				VA21902			
	<b>CENTERING PLATE</b> — 1-1/8" latch Front Filler Plate. Centers and supports latch bolt when used in hollow stile doors must be ordered with lock from factory.	\$75				V21904			
	<b>DISPOSABLE CORE FOR SFIC</b>	\$9				VA10100			
	<b>TAILPIECE WITH SPRING FOR SFIC HOUSING</b>	\$12				VP92905			
	<b>TAILPIECE FOR XGT/GT/GP KEY IN KNOB CYLINDER</b>	\$5				V32106			
	<b>DUST BOX FOR "T" STRIKE</b>	\$8				I0251			
	<b>DUST BOX FOR ASA (ANSI)</b>					Y025-SBX			
	<b>DUST BOX FOR FULL LIP STRIKE</b>					I0251R			
	<b>Boring Jig</b> — Locates off 2-1/8" bore to drill 5/16"DIA anti-rotation through-bolts	\$100				V11225			
	<b>LEVER RETURN SPRING</b>	\$5				V32015-1 V32015-2 V32015-3			

\*Available in 626 only. 1-1/8" faceplate-lock must be 2-3/4" Backset.



**XGT SERIES**  
CYLINDRICAL LOCKS

# XGT SERIES PARTS

## LIST PRICE

Effective July 3, 2023

XGT SERIES  
CYLINDRICAL LOCKS

REPLACEMENT LEVERS	DESCRIPTION	LIST PRICE	FINISHES						LIST PRICE	FINISH
			605	606	612	613E	622	625		
 <b>BOSTON</b>	Non-Cylinder Plain	\$150	V32319-5	V32319-8	V32319-3	V32319-6	V32319-H	V32319-2	\$140	V32319-7
	Non-Cylinder with button lock		V32321-5	V32321-8	V32321-3	V32321-6	V32321-H	V32321-2		V32321-7
	Conventional Key in Knob/Lever		V32320-5	V32320-8	V32320-3	V32320-6	V32320-H	V32320-2		V32320-7
	Small Format Interchangeable Core		V32327-5	V32327-8	V32327-3	V32327-6	V32327-H	V32327-2		V32327-7
 <b>MIAMI</b>	Non-Cylinder Plain		V32361-5	V32361-8	V32361-3	V32361-6	V32361-H	V32361-2		V32361-7
	Non-Cylinder with button lock		V32360-5	V32360-8	V32360-3	V32360-6	V32360-H	V32360-2		V32360-7
	Conventional Key in Knob/Lever		V32362-5	V32362-8	V32362-3	V32362-6	V32362-H	V32362-2		V32362-7
	Small Format Interchangeable Core		V32364-5	V32364-8	V32364-3	V32364-6	V32364-H	V32364-2		V32364-7
 <b>PHILADELPHIA</b>	Non-Cylinder Plain		V32305-5	V32305-8	V32305-3	V32305-6	V32305-H	V32305-2		V32305-7
	Non-Cylinder with button lock		V32307-5	V32307-8	V32307-3	V32307-6	V32307-H	V32307-2		V32307-7
	Conventional Key in Knob/Lever		V32306-5	V32306-8	V32306-3	V32306-6	V32306-H	V32306-2		V32306-7
	Small Format Interchangeable Core		V32322-5	V32322-8	V32322-3	V32322-6	V32322-H	V32322-2		V32322-7
	Large Format Interchangeable Core		—							V32427-7





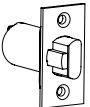

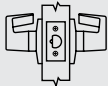
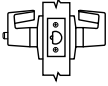

**ALL LEVERS**

LATCHBOLTS	DESCRIPTION	LIST PRICE	FINISHES						
			605	606	612	613E	622	625	626
	Standard Latchbolt With Dead Latch 2-3/4" Backset, 9/16" Throw for all functions. Faceplate: 2-1/4" X 1-1/8", Square Corners	\$130	V91904-511	V91904-811	V91904-311	V91904-611	V91904-H11	V91904-211	V91904-711

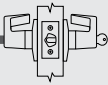
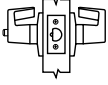
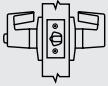
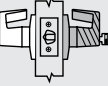
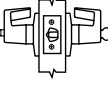
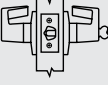
Note: Replacement latch for 3-3/4" Backset applications when used with V21902 extension or factory assembled locks with 2-3/8" Backset. NOT INTENDED FOR FIELD RETROFIT.

## PDQ Functions

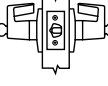
FUNCTION	FUNCTION NUMBER	INSIDE   OUTSIDE	DESCRIPTION	ANSI NUMBER
<b>NON KEYED</b>				
Passage / Closet	XGT126™		<ul style="list-style-type: none"> <li>Latchbolt operated by lever from either side at all times</li> </ul>	F75
Time Out Lock	XGT173		<ul style="list-style-type: none"> <li>Latchbolt by lever from either side unless push button on outside is depressed. Lock returns to passage mode upon release of push button.</li> <li>Inside lever locked only when pushing button on outside lever.</li> <li>Inside lever unlocked by emergency release of button from outside.</li> </ul> 	—
Hospital Privacy	XGT175		<ul style="list-style-type: none"> <li>Latchbolt operated by lever from either side or emergency turn piece in outside lever</li> <li>Outside lever locked by push button on inside</li> <li>Outside lever unlocked by emergency turn piece from outside, rotating inside lever, or closing door</li> </ul>	—
Privacy Bedroom / Bathroom	XGT176™		<ul style="list-style-type: none"> <li>Latchbolt operated by lever from either side or emergency release in outside lever</li> <li>Outside lever locked by push button on inside</li> <li>Outside lever unlocked by emergency release from outside, rotating inside lever, or closing door</li> </ul>	F76
Patio	XGT177		<ul style="list-style-type: none"> <li>Latchbolt operated by lever from either side</li> <li>Outside lever locked by push button on inside</li> <li>Outside lever unlocked by rotating inside lever, or closing door</li> <li>Outside lever has non-removable security features</li> </ul>	F77
<b>KEYED</b>				
Storeroom	XGT115		<ul style="list-style-type: none"> <li>Latchbolt operated by inside lever or key in outside lever</li> <li>Outside lever always fixed</li> </ul>	F86
Entrance	XGT116		<ul style="list-style-type: none"> <li>Latchbolt operated by lever from either side or key in outside lever</li> <li>Outside lever locked by push/turn button on inside</li> <li>When outside lever is locked by push button on inside – key from outside, or rotating inside lever unlocks outside lever</li> <li>When outside lever is locked by pushing and turning button on the inside, key from outside or rotating inside lever retracts latch but does not unlock outside lever</li> </ul>	F109
Security	XGT120		<ul style="list-style-type: none"> <li>Latchbolt operated by lever from either side</li> <li>Key on outside locks inside lever</li> <li>Key on outside unlocks inside lever</li> <li>Outside keyed lever always free</li> <li>Inside lever has non-removable security features</li> </ul> 	—
Utility Asylum / Institution	XGT128		<ul style="list-style-type: none"> <li>Both levers rigid</li> <li>Latchbolt retracted by key on both sides</li> <li>Can only gain entry or exit by key</li> </ul>	F87
Exit or Twin Communicating	XGT129		<ul style="list-style-type: none"> <li>Latchbolt operated by key in inside lever</li> <li>Inside lever always fixed</li> <li>Blank plate outside</li> <li>Minimum clearance of 1-1/2" between doors</li> <li>Frame depth 7-1/8"</li> </ul>	—
Vestibule Class Room Security	XGT135		<ul style="list-style-type: none"> <li>Latchbolt operated by lever from either side</li> <li>Key in either lever locks outside lever</li> <li>Key in either lever unlocks outside lever</li> <li>Inside lever always free</li> </ul>	F110





INDICATES RIGID LEVER

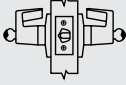
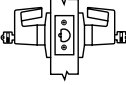
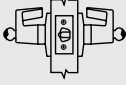
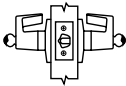
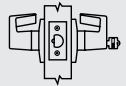

### PDQ Functions

XGT SERIES  
CYLINDRICAL LOCKS

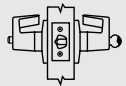
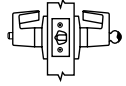
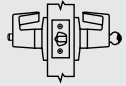
FUNCTION	FUNCTION NUMBER	INDISE   OUTSIDE	DESCRIPTION	ANSI NUMBER
<b>KEYED</b>				
Vestibule Class Room Security	XGT135LED		<ul style="list-style-type: none"> <li>Latchbolt operated by lever from either side</li> <li>Key in either lever locks outside lever</li> <li>Key in either lever unlocks outside lever</li> <li>Inside lever always free</li> <li>Red LED Outside Lever Status Indicator</li> <li>Lock Directional Arrow</li> <li>Patent #9,187,928</li> </ul>	F110
Store Door	XGT137		<ul style="list-style-type: none"> <li>Latchbolt operated by lever from either side</li> <li>Both levers locked by key from either side</li> <li>Both levers unlocked by key from either side</li> </ul>	F91
Communicating	XGT141		<ul style="list-style-type: none"> <li>Latchbolt operated by lever from either side</li> <li>Key in either side locks or unlocks its own lever independently</li> </ul>	F80
Vestibule Class Room Security	XGT145		<ul style="list-style-type: none"> <li>Latchbolt operated by lever from either side</li> <li>Key in either lever locks outside lever</li> <li>Key in either lever unlocks outside lever</li> <li>Inside lever always free</li> <li>Lock Directional Arrow*</li> </ul>	F110
Classroom	XGT148		<ul style="list-style-type: none"> <li>Latchbolt operated by lever from either side</li> <li>Outside lever locked by key from outside</li> <li>Outside lever unlocked by key from outside</li> <li>Inside lever always operates latch</li> </ul>	F84
Exit or Twin Communicating	XGT150		<ul style="list-style-type: none"> <li>Latchbolt operated by inside lever</li> <li>Blank plate outside</li> <li>Inside lever locked by key inside</li> <li>Inside lever unlocked by key inside</li> <li>Minimum clearance of 1-1/2" between doors</li> <li>Use only in rooms with more than one exit</li> <li>Frame depth 7-1/8"</li> </ul>	—
Service Station	XGT155		<ul style="list-style-type: none"> <li>Latchbolt operated by lever from either side or key in outside lever</li> <li>Outside lever locked by push button on inside</li> <li>When outside lever is locked by push button on inside – key from outside, rotating inside lever, or closing door unlocks outside lever</li> <li>When outside lever is locked by pushing and turning the slotted button on the inside, key from outside or rotating inside lever retracts latch but does not unlock outside lever</li> </ul>	F92
Dormitory / Corridor	XGT165		<ul style="list-style-type: none"> <li>Latchbolt operated by lever from either side or key in outside lever</li> <li>Outside lever locked by key on outside or push button on inside</li> <li>Outside lever unlocked by key in outside lever, closing door, or rotating inside lever</li> <li>Inside lever always free</li> </ul>	F90
Entry	XGT182		<ul style="list-style-type: none"> <li>Latchbolt operated by lever from either side or key in outside lever</li> <li>Outside lever locked by push button on inside</li> <li>Outside lever unlocked by key from outside, or rotating inside lever</li> </ul>	F82

## Cross Reference

**XGT SERIES**  
CYLINDRICAL LOCKS

ANSI # / FUNCTION	PDQ	SARGENT	CORBIN	SCHLAGE
F75 — PASSAGE	XGT 126	11U15	CL3310	ND10S
F76 — PRIVACY	XGT 176	11U65	CL3320	ND40S
F82 — ENTRY	XGT 182	11G24	CL3361	ND50PD
F84 — CLASSROOM	XGT 148	11G37	CL3355	ND70PD
F86 — STORE ROOM	XGT 115	11G04	CL3357	ND80PD
F90 — CORRIDOR	XGT 165	11G54	CL3375	ND73PD
F110 — INTRUDER CLASSROOM	XGT 135	11G38	CL3352	ND95PD
F110 — INTRUDER CLASSROOM W/LED INDICATOR	XGT 135 LED PDQ Exclusive - Patent #9,187,928	N/A	N/A	N/A

## Lever Cross Reference

PDQ	SARGENT	CORBIN	SCHLAGE
PHILADELPHIA — PHL	L Lever	NZD	RHO
BOSTON — BSN	P Lever	PZD	SPA
MIAMI — MIA	B Lever	AZD	ATH



PHILADELPHIA — PHL



BOSTON — BSN



MIAMI — MIA

Information on this sheet is compiled from public documents and third parties. As a result, PDQ makes no guarantees as to their accuracy, content, quality or availability. Comparisons were made using the technical features only and are not commercial comparisons. Final suitability should be determined by a professional hardware consultant.

 **ALL LEVERS**



ASSEMBLED  
IN THE USA

## Typical Applications

- Federal and State Government
- Healthcare
- Higher Education
- Hospitality
- Houses of Worship
- Industrial
- K-12 Education
- Offices
- Public Buildings

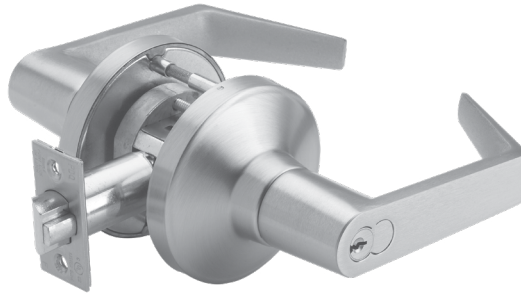

## Specifications



<b>FOR DOORS:</b>	• 1-3/4" to 2-1/4" thick • Preset for 1-3/4" door
<b>APPLICATION:</b>	• Through door thru-bolting
<b>DOOR PREP:</b>	• Standard ANSI A156.115 (161) for Cylindrical Locks
<b>BACKSET:</b>	• 2-3/4" Standard. 3-3/4" and 5" Optional (Ordered from factory only).
<b>CHASSIS:</b>	• Heavy duty diecast, investment cast, chromated cold rolled steel and stainless steel mechanism. Billet Steel spindles for locking functions
<b>FRONT:</b>	• 2-1/4" x 1-1/8" • Stainless Steel or Wrought Brass • Beveled 1/8" in 2"
<b>STRIKE</b>	• ASA standard • T-Strike or Full Lip Strike optional • Stainless Steel or Wrought Brass
<b>LEVERS:</b>	• Philadelphia (SFL and LFL), Boston (SFL), Miami (SFL)
<b>ROSE:</b>	• 3-3/8" DIA Wrought
<b>LATCHBOLT:</b>	• 9/16" Throw Deadlocking
<b>HAND:</b>	• Non-handed
<b>TRIM:</b>	• Solid diecast PHL, BSN or MIA Levers • 41° Lever Rotation Standard with 2-3/4" Backset • Wrought Brass Roses, Concealed Screws • 65° Lever Rotation Standard with 3/4" latch for double doors (Ordered from factory only) and all 2-3/8", 3-3/4" and 5" Backsets (Ordered from factory only)
<b>KEYS:</b>	• Two (2) per Lock
<b>KEYWAYS</b>	• SCC standard (Schlage C Compatible) • Also available in keyways of other manufacturers
<b>INTERCHANGEABLE CORE:</b>	• Available for all keyed functions • 6 or 7-pin • Large Format IC Core available for PHL Lever ONLY. • Compatible with Best, Falcon and Arrow small format IC cores
<b>CYLINDER:</b>	• 6-pin Brass Insert Cylinder keyed to 5-pins • Standard High Security and UL437 Cylinders Available
<b>KEYING:</b>	• Options: MK, CMK or GMK • Zero Bitted (KO), Keyed Different (KD) or Keyed Alike (KA) Can be keyed into existing master key systems
<b>FINISHES:</b>	• 605 (US3), 606 (US4), 612 (US10), 613E, 619 (US15), 622 (US19), 625 (US26), 626 (US26D) • Optional Antimicrobial Coating 626 (USD26D) only†
<b>CERTIFICATIONS, LISTINGS, COMPLIANCES:</b>	• UL listed for 3 hrs, for single doors up to 4'0" x 8'0" • Certified to ANSI/BHMA A156.2, Grade 1 • California Education Code Compliant (Functions GT135, GT135LED, GT145) • Federal Specification FF-H-10C (Superseded by A156.2) • Approved for Florida HVHZ (High Velocity Hurricane Zone). PDQ Product Approval: FL 21376. Design load rating: ± 70.0 PSF for single door (3' x 7') • Complies with ADA (Americans with Disabilities Act) and ICC/ANSI 117.1 for Accessible and Usable Buildings
<b>WARRANTY:</b>	• Twenty-five (25) year Limited Warranty
<b>COUNTRY OF ORIGIN:</b>	• Proudly Assembled in the U.S.A. with U.S. and foreign material. Meets requirements of the Buy American Act as a COTS product manufactured in the United States.

† Available with antimicrobial powder coating, treated with silver ionic technology that is known to inhibit the growth of microbes.



# GT SERIES

# LIST PRICE

## How to Order



Effective July 3, 2023

QUANTITY	SERIES	FUNCTION	LEVER	FINISH	BACKSET	STRIKE	CYLINDER	KEYWAY	KEYING	OPTION
6	GT	150	PHL	626	234	ASA	D	SCC	KD	—
<p>NOTE: Case quantity is 6/ case weight is 33lbs. Keyed Functions/Case Weight is 31lbs. Non-Keyed Functions/ For split finishes, designate O/S trim first, then I/S</p>										
			BSN	605	234 — 2-3/4" (default)	ASA — ANSI/ ASA (default)	D Default	PAGE 49		TC1S — Tactile Abrasive Coating - Inside only
			MIA	606	334 — 3-3/4"	FL — Full Lip	L Less Cylinder			TC1OS — Tactile Abrasive Coating - Outside only
			PHL	612	5 — 5"	T — "T" Strike	SF6 Lock is SFIC prepped w/ 6 pin core			TC2 — Tactile Abrasive Coating - Both Sides
				613E			SF7 Lock is SFIC prepped w/ 7 pin core			SF — Split Finishes
				619			SFL Lock is SFIC prepped but less core			LL — Lead-Linked Rose
				622			SFC Lock is SFIC prepped w/ construction core			DB — Dust Box
				625			SFP Lock is SFIC prepped w/ plastic construction core			AM — Antimicrobial Coating
				626			LF6 Lock is Schlage LFIC prepped w/ Schlage core			ISMC - Industry Standary Molex Connector
							LFL Lock is Schlage LFIC prepped but less core			REX — Request to Exit
							LFC Lock is Schlage LFIC prepped w/ construction core			W - Weatherized (626 Only)
										PAGE 50

GT SERIES  
CYLINDRICAL LOCKS

## Locksets - Standard and Interchangeable Cores

ANSI NO.	FUNCTION	DESCRIPTION	626	605/606/612 613E/619/622/625
<b>NON-CYLINDER</b>				
F89	124	Exit		
	125	Communicating	\$338.00	\$360.00
F75	126	Passage		
	173	Time Out		
	175	Hospital / Privacy	\$385.00	\$407.00
F76	176	Privacy		
F77	177	Patio / Privacy		
	205	Double Dummy	\$222.00	\$244.00
	211	Single Dummy	\$140.00	\$151.00
<b>SINGLE CYLINDER</b>				
F86	115	Store Room		
F109	116	Entrance		
F84	148	Classroom	\$449.00	\$471.00
	150	Exit / Twin Communicating		
F82	182	Office / Entry		
	120	Security	\$469.00	\$491.00
	129	Exit / Twin Communicating	\$509.00	\$531.00
F92	155	Service Station		
F90	165	Dormitory / Corridor		
<b>DOUBLE CYLINDER</b>				
F87	128	Institution	\$519.00	\$541.00
F110	135	Classroom / Security		
F110	135LED	Classroom/Security w/Red LED Outside Lever Status Indicator	\$688.00	\$710.00
F110	145	Classroom / Security w/Locking Direction Arrow		
F91	137	Store Door	\$543.00	\$565.00
F80	141	Communicating		
<b>ELECTRIFIED</b>				
	199A	Store Room	\$929.00	\$951.00

CYLINDER OPTIONS	ICON	LOCK ADJUSTMENT
D		
SFL		N/C
LFL*		

IC Core not included see page 49 for core options.

LFC prep only available in PHL lever and 613E, 622, 626 finish.

### NOTES:

- Locks will be furnished with ASA Strike & SCC Keyway unless otherwise stated

## Trim/Levers

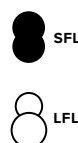

### Backset

CODE	DESCRIPTION	LOCK ADJUSTMENT
<b>2-3/4" BACKSET</b>		
234	2-3/4" Deadlocking 2-1/4" x 1-1/8"	N/C
<b>3-3/4" BACKSET</b>		
334F	2-1/4" x 1-1/8"	\$18
334	2-1/4" x 1"	
<b>5" BACKSET</b>		
5	2-1/4" x 1-1/8"	\$24

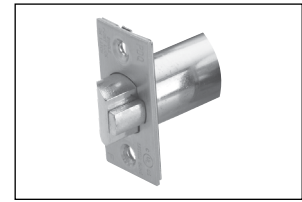

Latchbolt

GT SERIES  
CYLINDRICAL LOCKS

### Strikes

	CODE	DESCRIPTION	LOCK ADJUSTMENT
	ASA	ASA Strike (any finish) 1-1/4" x 4-7/8"	N/C
	T	T-Strike (any finish) 1-1/8" x 2-3/4"	
	FL	Full Lip Strike (any finish) 1-5/8" x 2-1/4"	

**NOTES:**

- Specify finish for Strikes & Latchbolts if ordered separately

**NOTES:**

- Specify finish for cylinders ordered separately
- Kwikset cylinder available in 5 pin only
- Specify KD, KA4, or 1 bitted 6 pin cylinder keyed for 5 pin

### Keyways and Cylinders

PDQ KEYWAY	COMPATIBLE WITH	SOLD WITH LOCK
AR1	Arrow / AR1	N/C
CO59A1	Corbin / 59A1	
CO6	Corbin / 60	
CL4	Corbin / L4	
RUD	Russwin / D1	
SCE	Schlage / E	
SCC	Schlage / C	
SCC-K	Schlage / C-K	
SAL	Sargent / LA	
RA-RC	Sargent / RA-RC	
YA8	Yale / E1R	
GA	Yale / GA	
FAL	Falcon / E-R	
KW	Kwikset	
TA	PDQ / TA (Restricted. Limited to Grandmaster systems w/4 masters)	
Dummy	—	
T-Turn	—	
L	Less Cylinder	Deduct \$4.00
<b>HIGH SECURITY CYLINDERS AND CORES</b>		
SEE HIGH SECURITY CYLINDERS AND CORES SECTION, PAGE 118.		

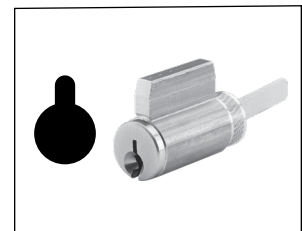

Key in Knob/Lever Cylinder



UL 437 and High Security Cylinders

## Cores and Keyways

DESCRIPTION	PDQ NO.	ADD
<b>SMALL FORMAT UNCOMBINATED</b>		
6 Pin Cores	I5206 + KEYWAY	\$40.00
7 Pin Cores	I5207 + KEYWAY	
<b>COMBINATED</b>		
6 Pin Cores	I5206-1 + KEYWAY	\$60.00
7 Pin Cores	I5207-1 + KEYWAY	
<b>BEST™ Compatible</b>		
A (DEFAULT), B, C, D, E, F, G, H, J, K, L, M, Q,		
WA, WB, WC, WG, WH, TB, TD, TE, & R		
<b>PDQ Exclusive</b>		
PDQ1, PDQ2		
<b>PDQ Exclusive and Restricted</b>		
PDQ3		
<b>SFIC CONSTRUCTION</b>		
Construction Core 6-pin only		\$60.00
Dummy Construction Core Plastic		\$8.00
<b>LFIC CONSTRUCTION</b>		
Construction Core 6-pin only. <b>Construction cores are invoiced at shipment and credited upon return.</b>		\$70.00
IC Tailpiece Assembly		\$10.00
<b>LFIC COMBINATED</b>		
Schlage compatible LFIC, SCC (Schlage C compatible) keyway		\$70.00
PDQ TA LFIC Restricted		
<b>LFIC UNCOMBINATED</b>		
Schlage compatible LFIC, SCC (Schlage C compatible) keyway		\$50.00
<b>HIGH SECURITY IC CORES</b>		
SEE HIGH SECURITY CYLINDERS AND CORES SECTION, PAGE 118. — LFIC REQUIRES LARGE FORMAT LEVER		

- NOTES:**
- Specify finish for IC Cores ordered separately
  - Control keys must be ordered separately
  - PDQ1, PDQ2, PDQ3 (Restricted)**, Best A2 & A4 Systems Available

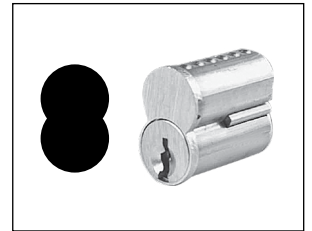

SFL/SFIC Core

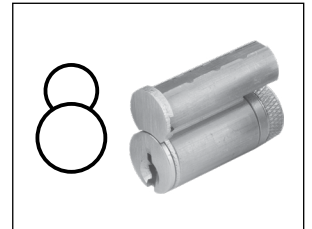

LFL/LFIC Schlage Format

















UL 437 and High Security Cylinders

### Options

CODE	DESCRIPTION	LIST PRICE
<b>TC1IS</b>	Tactile Abrasive Coating - Inside only	\$26.00
<b>TC1OS</b>	Tactile Abrasive Coating - Outside only	
<b>TC2</b>	Tactile Abrasive Coating - Both Sides	\$52.00
<b>LL</b>	Lead-Lined Rose	\$214.00
<b>DB</b>	Dust Box	\$8.00
<b>AM</b>	Antimicrobial Coating, Lever Set Includes Inside and Outside Lever and Rose (Not available with 605 or 625 finish)	\$37.00
<b>REX</b>	Request to Exit	\$122.00
<b>ISMC</b>	Industry Standard Molex Connector	\$108.00
<b>W</b>	Weatherized Finish - 626 Only	\$80.00

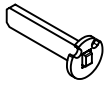
# GT SERIES PARTS

**LIST PRICE**  
Effective July 3, 2023

	DESCRIPTION	LIST PRICE	FINISHES							
			N/A	605	606	612	613E	622	625	626
	<b>Push Button</b> For Functions GT155, GT165, GT173, GT175, GT176, GT177, GT182	\$13	—	VA91302-5	VA91302-8	VA91302-3	VA91302-6	VA91302-H	VA91302-2	VA91302-7
	<b>Outside Rose</b> for All Functions, Inside Rose For All functions except GT135LED, GT145	\$43	—	V32006-5	V32006-8	V32006-3	V32006-6	V32006-H	V32006-2	V32006-7
	<b>Inside Rose</b> w/Locking Directional Arrow For Functions GT135LED, GT145		—	VA10093-5	VA10093-8	VA10093-3	VA10093-6	VA10093-H	VA10093-2	VA10093-7
	<b>"T" STRIKE SQUARE CORNERS</b> 1-1/8" X 2-3/4" X 3/32"	\$17	—	V919050-5	V919050-8	V919050-3	V919050-6	V919050-H	V919050-2	V919050-7
	<b>ASA ANSI STRIKE</b> 1-1/4" X 4-7/8" X 3/32"	\$38	—	V91905-5	V91905-8	V91905-3	V91905-6	V91905-H	V91905-2	V91905-7
	<b>"FULL LIP" STRIKE</b> 1-5/8" X 2-1/4" X 3/32"	\$14	—	V919051-5	V919051-8	V919051-3	V919051-6	V919051-H	V919051-2	V919051-7
	<b>SCREW PACK - INCLUDES MOUNTING SCREWS, HEX KEY(M5 X .8) AND PICK.</b>	\$12	—	VA10030-5	VA10030-8	VA10030-3	VA10030-6	VA10030-H	VA10030-2	VA10030-7
	<b>SPACER</b> — For 1-3/8" doors. Sold as a pair. To be installed as a set.	\$64	V32433							
	<b>EXTENSION</b> — Converts standard latchbolt from 2-3/4" Backset to 5"	\$58	VA21902							
	<b>CENTERING PLATE</b> — 1-1/8" latch Front Filler Plate. Centers and supports latch bolt when used in hollow stile doors must be ordered with lock from factory.	\$75	V21904							
	<b>DISPOSABLE CORE FOR SFIC</b>	\$9	VA10100							
	<b>TAILPIECE WITH SPRING FOR SFIC HOUSING</b>	\$12	VP92905							
	<b>TAILPIECE FOR XGT/GT/GP KEY IN KNOB CYLINDER</b>	\$5	V32106							
	<b>DUST BOX FOR "T" STRIKE</b>	\$8	I0251							
	<b>DUST BOX FOR ASA (ANSI)</b>		Y025-SBX							
	<b>DUST BOX FOR FULL LIP STRIKE</b>		I0251R							
	<b>Boring Jig</b> — Locates off 2-1/8" bore to drill 5/16"DIA anti-rotation through-bolts	\$100	V11225							
	<b>LEVER RETURN SPRING</b>	\$5	V32015-1 V32015-2 V32015-3							

**GT SERIES**  
CYLINDRICAL LOCKS



\*Available in 626 only. 1-1/8" faceplate-lock must be 2-3/4" Backset.

# GT SERIES PARTS

**LIST PRICE**

Effective July 3, 2023

**GT SERIES**  
CYLINDRICAL LOCKS

REPLACEMENT LEVERS	DESCRIPTION	LIST PRICE	FINISHES						LIST PRICE	FINISH	
			605	606	612	613E	622	625			
 <b>BOSTON</b>	Non-Cylinder Plain	\$150	V32319-5	V32319-8	V32319-3	V32319-6	V32319-H	V32319-2	\$140	V32319-7	
	Non-Cylinder with button lock		V32321-5	V32321-8	V32321-3	V32321-6	V32321-H	V32321-2		V32321-7	
	Conventional Key in Knob/Lever		V32320-5	V32320-8	V32320-3	V32320-6	V32320-H	V32320-2		V32320-7	
	Small Format Interchangeable Core		V32327-5	V32327-8	V32327-3	V32327-6	V32327-H	V32327-2		V32327-7	
 <b>MIAMI</b>	Non-Cylinder Plain		V32361-5	V32361-8	V32361-3	V32361-6	V32361-H	V32361-2		V32361-7	
	Non-Cylinder with button lock		V32360-5	V32360-8	V32360-3	V32360-6	V32360-H	V32360-2		V32360-7	
	Conventional Key in Knob/Lever		V32362-5	V32362-8	V32362-3	V32362-6	V32362-H	V32362-2		V32362-7	
	Small Format Interchangeable Core		V32364-5	V32364-8	V32364-3	V32364-6	V32364-H	V32364-2		V32364-7	
 <b>PHILADELPHIA</b>	Non-Cylinder Plain		-	V32305-5	V32305-8	V32305-3	V32305-6	V32305-H		V32305-2	V32305-7
	Non-Cylinder with button lock			V32307-5	V32307-8	V32307-3	V32307-6	V32307-H		V32307-2	V32307-7
	Conventional Key in Knob/Lever			V32306-5	V32306-8	V32306-3	V32306-6	V32306-H		V32306-2	V32306-7
	Small Format Interchangeable Core			V32322-5	V32322-8	V32322-3	V32322-6	V32322-H		V32322-2	V32322-7
	Large Format Interchangeable Core								V32427-7		





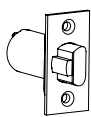



**ALL LEVERS**

LATCHBOLTS	DESCRIPTION	LIST PRICE	FINISHES						
			605	606	612	613E	622	625	626
	Standard Latchbolt With Dead Latch 2-3/4" Backset, 9/16" Throw for all functions. Faceplate: 2-1/4" X 1-1/8", Square Corners	\$130	V91904-511	V91904-811	V91904-311	V91904-611	V91904-H11	V91904-211	V91904-711

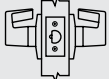
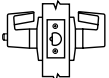
Note: Replacement latch for 3-3/4" Backset applications when used with V21902 extension or factory assembled locks with 2-3/8" Backset. NOT INTENDED FOR FIELD RETROFIT.

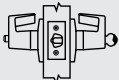
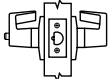
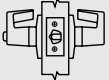
## PDQ Functions





FUNCTION	FUNCTION NUMBER	INSIDE   OUTSIDE	DESCRIPTION	ANSI NUMBER
<b>NON KEYED</b>				
Exit	GT124		<ul style="list-style-type: none"> <li>Latchbolt operated by inside lever at all times</li> <li>Outside lever always fixed</li> <li>Outside lever has non-removable security features</li> </ul>	F89
Communicating	GT125		<ul style="list-style-type: none"> <li>Latchbolt operated by inside lever</li> <li>Blank plate outside</li> <li>Minimum clearance of 1-1/2" between doors</li> <li>Frame depth 7-1/8"</li> </ul>	—
Passage / Closet	GT126™		<ul style="list-style-type: none"> <li>Latchbolt operated by lever from either side at all times</li> </ul>	F75
Time Out Lock	GT173		<ul style="list-style-type: none"> <li>Latchbolt by lever from either side unless push button on outside is depressed. Lock returns to passage mode upon release of push button.</li> <li>Inside lever locked only when pushing button on outside lever.</li> <li>Inside lever unlocked by emergency release of button from outside.</li> </ul> 	—
Hospital Privacy	GT175		<ul style="list-style-type: none"> <li>Latchbolt operated by lever from either side or emergency turn piece in outside lever</li> <li>Outside lever locked by push button on inside</li> <li>Outside lever unlocked by emergency turn piece from outside, rotating inside lever, or closing door</li> </ul>	—
Privacy Bedroom / Bathroom	GT176™		<ul style="list-style-type: none"> <li>Latchbolt operated by lever from either side or emergency release in outside lever</li> <li>Outside lever locked by push button on inside</li> <li>Outside lever unlocked by emergency release from outside, rotating inside lever, or closing door</li> </ul>	F76
Patio	GT177		<ul style="list-style-type: none"> <li>Latchbolt operated by lever from either side</li> <li>Outside lever locked by push button on inside</li> <li>Outside lever unlocked by rotating inside lever, or closing door</li> <li>Outside lever has non-removable security features</li> </ul>	F77
Double Dummy	GT205		<ul style="list-style-type: none"> <li>Pull lever both sides</li> <li>No mechanical operation</li> </ul>	—
Single Dummy	GT211		<ul style="list-style-type: none"> <li>Pull lever one side</li> <li>No mechanical operation</li> </ul>	—

**GT SERIES**  
CYLINDRICAL LOCKS

 INDICATES RIGID LEVER

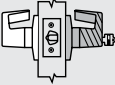
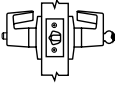
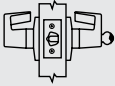
### PDQ Functions

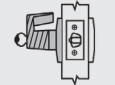
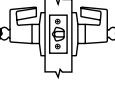
GT SERIES  
CYLINDRICAL LOCKS

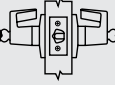
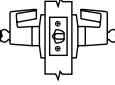
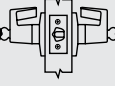
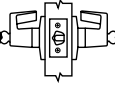



FUNCTION	FUNCTION NUMBER	INSIDE   OUTSIDE	DESCRIPTION	ANSI NUMBER
<b>KEYED</b>				
Storeroom	GT115		<ul style="list-style-type: none"> <li>Latchbolt operated by inside lever or key in outside lever</li> <li>Outside lever always fixed</li> </ul>	F86
Entrance	GT116		<ul style="list-style-type: none"> <li>Latchbolt operated by lever from either side or key in outside lever</li> <li>Outside lever locked by push/turn button on inside</li> <li>When outside lever is locked by push button on inside – key from outside, or rotating inside lever unlocks outside lever</li> <li>When outside lever is locked by pushing and turning button on the inside, key from outside or rotating inside lever retracts latch but does not unlock outside lever</li> </ul>	F109
Security	GT120		<ul style="list-style-type: none"> <li>Latchbolt operated by lever from either side</li> <li>Key on outside locks inside lever</li> <li>Key on outside unlocks inside lever</li> <li>Outside keyed lever always free</li> <li>Inside lever has non-removable security features</li> </ul>	—
Utility Asylum / Institution	GT128		<ul style="list-style-type: none"> <li>Both levers rigid</li> <li>Latchbolt retracted by key on both sides</li> <li>Can only gain entry or exit by key</li> </ul>	F87
Exit or Twin Communicating	GT129		<ul style="list-style-type: none"> <li>Latchbolt operated by key in inside lever</li> <li>Inside lever always fixed</li> <li>Blank plate outside</li> <li>Minimum clearance of 1-1/2" between doors</li> <li>Frame depth 7-1/8"</li> </ul>	—
Vestibule Class Room Security	GT135		<ul style="list-style-type: none"> <li>Latchbolt operated by lever from either side</li> <li>Key in either lever locks outside lever</li> <li>Key in either lever unlocks outside lever</li> <li>Inside lever always free</li> </ul>	F110
Vestibule Class Room Security	 GT135LED		<ul style="list-style-type: none"> <li>Latchbolt operated by lever from either side</li> <li>Key in either lever locks outside lever</li> <li>Key in either lever unlocks outside lever</li> <li>Inside lever always free</li> <li>Red LED Outside Lever Status Indicator</li> <li>Lock Directional Arrow</li> <li>Patent # 9,187,928</li> </ul>	F110
Store Door	GT137		<ul style="list-style-type: none"> <li>Latchbolt operated by lever from either side</li> <li>Both levers locked by key from either side</li> <li>Both levers unlocked by key from either side</li> </ul>	F91
Communicating	GT141		<ul style="list-style-type: none"> <li>Latchbolt operated by lever from either side</li> <li>Key in either side locks or unlocks its own lever independently</li> </ul>	F80
Vestibule Class Room Security	GT145		<ul style="list-style-type: none"> <li>Latchbolt operated by lever from either side</li> <li>Key in either lever locks outside lever</li> <li>Key in either lever unlocks outside lever</li> <li>Inside lever always free</li> <li>Lock Directional Arrow</li> </ul>	F110



INDICATES RIGID LEVER

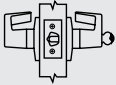

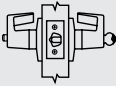
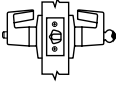
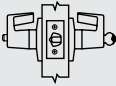
## PDQ Functions

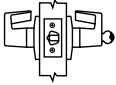
FUNCTION	FUNCTION NUMBER	INSIDE   OUTSIDE	DESCRIPTION	ANSI NUMBER
<b>KEYED</b>				
Classroom	GT148		<ul style="list-style-type: none"> <li>Latchbolt operated by lever from either side</li> <li>Outside lever locked by key from outside</li> <li>Outside lever unlocked by key from outside</li> <li>Inside lever always operates latch</li> </ul>	F84
Exit or Twin Communicating	GT150		<ul style="list-style-type: none"> <li>Latchbolt operated by inside lever</li> <li>Blank plate outside</li> <li>Inside lever locked by key inside</li> <li>Inside lever unlocked by key inside</li> <li>Minimum clearance of 1-1/2" between doors</li> <li>Use only in rooms with more than one exit</li> <li>Frame depth 7-1/8"</li> </ul>	—
Service Station	GT155		<ul style="list-style-type: none"> <li>Latchbolt operated by lever from either side or key in outside lever</li> <li>Outside lever locked by push button on inside</li> <li>When outside lever is locked by push button on inside – key from outside, rotating inside lever, or closing door unlocks outside lever</li> <li>When outside lever is locked by pushing and turning the slotted button on the inside, key from outside or rotating inside lever retracts latch but does not unlock outside lever</li> </ul>	F92
Dormitory / Corridor	GT165		<ul style="list-style-type: none"> <li>Latchbolt operated by lever from either side or key in outside lever</li> <li>Outside lever locked by key on outside or push button on inside</li> <li>Outside lever unlocked by key in outside lever, closing door, or rotating inside lever</li> <li>Inside lever always free</li> </ul>	F90
Entry	GT182		<ul style="list-style-type: none"> <li>Latchbolt operated by lever from either side or key in outside lever</li> <li>Outside lever locked by push button on inside</li> <li>Outside lever unlocked by key from outside, or rotating inside lever</li> </ul>	F82
Electrified Storeroom	 GT199A		<ul style="list-style-type: none"> <li>Key outside retracts latchbolt</li> <li>Latchbolt operated by lever from inside</li> <li>Auxiliary latch deadlocks latchbolt</li> <li>Fail safe—latchbolt operated by lever from outside unless electrically locked</li> <li>Fail secure—latchbolt operated by lever from outside when electrically unlocked</li> <li>Accepts 12VDC@.6A, 12VAC@.6A, 24VDC@.3A and 24VAC@.3A</li> <li>Furnished with 6" wire leads</li> </ul>	—



**GT SERIES**  
CYLINDRICAL LOCKS

## Cross Reference

ANSI # / FUNCTION	PDQ	BEST	CORBIN	DORMA	FALCON T SERIES	HAGER	MARKS 95 SERIES	SARGENT	SCHLAGE	ACCENTRA
F75 PASSAGE	GT 126	93K N	CL3510	C810	101	3410	N	10U15	ND10S	5401LN
F76 PRIVACY	GT 176	93K L	CL3520	C840	301	3440	L	10U65	ND40S	5402LN
F82 ENTRY	GT 182	93K A	CL3561	C850	501	3450	A	10G24	ND50PD	5404LN
F109 ENTRANCE	GT 116	93K AB	CL3551	C853	N/A	3453	N/A	10G05	ND53PD	5404LN
F84 CLASSROOM	GT 148	93K R	CL3555	C870	561	3470	S	10G37	ND70PD	5408LN
F86 STORE ROOM	GT 115	93K D	CL3557	C880	581	3480	F	10G04	ND80PD	5405LN
F90 CORRIDOR	GT 165	93K KT	N/A	C873	571	3473	T	10G54	ND73PD	5422LN
F110 INTRUDER CLASSROOM	GT 135	93K IN	N/A	C877	381	3495	DB	10G38	ND95PD	5418LN
F110 INTRUDER CLASSROOM W/LED INDICATOR	GT 135 LED PDQ Exclusive - Patent #9,187,928	N/A	N/A	N/A	N/A	N/A	N/A	N/A	N/A	N/A
SINGLE DUMMY	GT 211	93K 1DT	CL3550	C801	12	3417	DO	10U93	ND170	5455LN

GT SERIES  
CYLINDRICAL LOCKS

## Lever Cross Reference

PDQ	BEST	CORBIN	DORMA	FALCON	HAGER	MARKS	SARGENT	SCHLAGE	ACCENTRA
PHL — PHILADELPHIA	15	NZD	LR	D	WTS	195	L Lever	RHO	AU
BOSTON — BSN	14	PZD	LC	Q	ARC	295	P Lever	SPA	PB
MIAMI — MIA	16	AZD	LG	A	AUS	495	B Lever	ATH	MO



PHILADELPHIA — PHL



BOSTON — BSN



MIAMI — MIA

Information on this sheet is compiled from public documents and third parties. As a result, PDQ makes no guarantees as to their accuracy, content, quality or availability. Comparisons were made using the technical features only and are not commercial comparisons. Final suitability should be determined by a professional hardware consultant.

 **ALL LEVERS**

## Typical Applications

- Apartments
- Back-of-House Hotel/Motel
- Commercial Buildings
- Government Buildings
- High Traffic Areas
- Healthcare
- Houses of Worship
- Military Barracks
- Retail Backroom
- Retrofit/Repair/Replacement

## Features

- UL listed for 3-hour fire door
- Exceeds ANSI/BHMA A156.2 Grade 1
- 5 standard functions
- Various strike and latch options to accommodate any opening
- Available in keyways of most major manufacturers
- Tactile abrasive coating option
- Antimicrobial coating option
- Five (5) year limited warranty







## Specifications



<b>FOR DOORS:</b>	• 1-3/8" to 2" thick.
<b>DOOR PREP:</b>	• Fits Standard 160 or 161 Door Prep.
<b>BACKSET:</b>	• 2-3/8", 2-3/4", 3-3/4", 5".
<b>CASE:</b>	• Steel, Yellow Chromate Plate
<b>FRONT:</b>	• 2-1/4" x 1-1/8" or 2-1/4" x 1" • Stainless Steel or Wrought Bronze.
<b>STRIKE:</b>	• 4-7/8" x 1-1/4" (ASA). "T" or "FL" Strike Optional. • Stainless Steel or Wrought Bronze.
<b>UL F LATCHBOLT:</b>	• 3 hours of fire testing qualified, stainless steel latch bolt.
<b>ROSE:</b>	• 3" DIA Wrought.
<b>HAND:</b>	• Non-handed.
<b>TRIM:</b>	• CQ ball knob. Stainless steel or wrought brass.
<b>KEYWAYS:</b>	• Available in keyways of most major manufacturers.
<b>CYLINDER:</b>	• Supplied standard to accommodate SFIC core. (Cylinder not included). • Standard High Security and UL437 Cylinders Available
<b>KEYING:</b>	• Standard core is available and can be MK, CMK, GMK, or CK. Available Zero Bitted (KO), Keyed Different (KD), Keyed Alike (KA). Can be keyed into existing masterkey systems of other manufacturers.
<b>FINISHES:</b>	• 630 (US32D)
<b>WARRANTY:</b>	• Five (5) Year Limited Warranty
<b>CERTIFICATIONS, LISTINGS, COMPLIANCES:</b>	• Meets ANSI/BHMA A156.2–2003 Grade 1, surpassed 800,000 cycles • UL/CUL 10C listed for 3 hrs, for single doors up to 4'0" x 8'0" • TAA compliant. Country of origin: Taiwan

‡ Available with antimicrobial coating, technology that is known to inhibit the growth of microbes.

## PDQ Functions

FUNCTION	FUNCTION NUMBER	INSIDE   OUTSIDE	DESCRIPTION	ANSI NUMBER
<b>NON KEYED</b>				
Passage	126		<ul style="list-style-type: none"> <li>Latchbolt operated by both knobs</li> </ul>	F75
Privacy Bathroom	176		<ul style="list-style-type: none"> <li>Latchbolt operated by both knobs</li> <li>Push button in inside knob locks outside knob</li> <li>Inside knob or closing door releases button</li> <li>Emergency opening from outside</li> </ul>	F76
<b>KEYED</b>				
Storeroom	115		<ul style="list-style-type: none"> <li>Latchbolt operated from outside by key, inside by knob</li> <li>Outside knob is rigid at all times</li> <li>Inside knob always free for immediate exit</li> <li>Deadlocking (guarded) latchbolt</li> </ul>	F86
Entrance	116		<ul style="list-style-type: none"> <li>Latchbolt operated by both knobs</li> <li>Outside knob locked or unlocked by turn/push button</li> <li>Inside knob always free</li> <li>Pushing and turning button locks outside knob requiring use of key until button is manually unlocked</li> <li>Pushing button only locks outside knob until unlocked with key or inside knob is turned</li> </ul>	F109
Classroom	148		<ul style="list-style-type: none"> <li>Latchbolt operated from outside by knob except when locked from outside by key</li> <li>Latchbolt operated from inside by knob at all times</li> <li>Deadlocking (guarded) latchbolt</li> </ul>	F84



## How to Order



QUANTITY	SERIES	FUNCTION	KNOB	FINISH	BACKSET	STRIKE	CYLINDER	KEYWAY	KEYING	OPTION	
20	SX	116	CQ	630	234	ASA	D	SCC	KD	—	
NOTE: Case quantity is 10 / Case weight is 32 lbs. Keyed Functions / Case weight is 40 lbs. Non-Keyed Functions / For split finishes, designate O/S trim first, then I/S					<b>234</b> — 2-3/4" <b>238</b> — 2-3/8" <b>334</b> — 3-3/4" <b>5</b> — 5"	<b>ASA</b> — ANSI/ASA (default) <b>FL</b> — Full Lip <b>T</b> — "T" Strike	<b>D</b> Default <b>L</b> Less Cylinder <b>SF6</b> Lock is SFIC prepped w/ 6 pin core <b>SF7</b> Lock is SFIC prepped w/ 7 pin core <b>SFL</b> Lock is SFIC prepped but less core <b>SFC</b> Lock is SFIC prepped w/ construction core <b>SFP</b> Lock is SFIC prepped w/ plastic construction core	<b>PAGE 60</b>		<b>DB</b> — Dust Box <b>AM</b> — Antimicrobial Coating	
					<b>PAGE 59</b>	<b>PAGE 60</b>					<b>PAGE 61</b>

## Locksets

ANSI NO.	FUNCTION	DESCRIPTION	630
<i>NON-CYLINDER</i>			
F75	126	Passage	\$220.00
F76	176	Privacy	\$265.00
<i>SINGLE CYLINDER</i>			
F86	115	Storeroom	\$285.00
F109	116	Entrance	
F84	148	Classroom/Storage	
<b>List prices shown include conventional key in knob/lever cylinder. For I-C, list prices do not include core.</b>			

CYLINDER OPTIONS	ICON	LOCK ADJUSTMENT
D		N/C
SFL		

## Trim



**NOTES:**

- Locks will be furnished with 2-3/4" Latchbolt, ASA Strike & SCC Keyway unless otherwise stated
- 2-3/4" Latchbolt will be furnished with 2-1/4" x 1-1/8" faceplate unless otherwise stated

## Backset

CODE	DESCRIPTION	LOCK ADJUSTMENT
<b>2-3/4" BACKSET</b>		
234	2-1/4" x 1-1/8"	N/C
234F	2-1/4" x 1"	
234FR	2-1/4" x 1" x 1/4" Radius	\$5.00
<b>2-3/8" BACKSET</b>		
238F	2-1/4" x 1-1/8"	N/C
238	2-1/4" x 1"	
238R	2-1/4" x 1" x 1/4" Radius	\$5.00
<b>3-3/4" BACKSET</b>		
334F	2-1/4" x 1-1/8"	\$18.00
334	2-1/4" x 1"	
334R	2-1/4" x 1" x 1/4" Radius	
<b>5" BACKSET</b>		
5	2-1/4" x 1-1/8"	\$24.00
5F	2-1/4" x 1"	
5FR	2-1/4" x 1" x 1/4" Radius	



Latchbolt



Deadlatch

## Strikes

	CODE	DESCRIPTION	LOCK ADJUSTMENT
	ASA	ASA Strike 1-1/4" x 4-7/8" 630 (US32D) Stainless Steel	N/C
	T	T-Strike 1-1/8" x 2-3/4" 630 (US32D) Stainless Steel	
	FL	Full Lip Strike 1-5/8" x 2-1/4" (US32D) Stainless Steel	

**NOTES:**

- Specify desired finish for Strikes & Latchbolts if ordered separately

### Keyways and Cylinders

PDQ KEYWAY	COMPATIBLE WITH	SOLD WITH LOCK	
AR1	Arrow / AR1	N/C	
CO59A1	Corbin / 59A1		
CO6	Corbin / 60		
CL4	Corbin / L4		
RUD	Russwin / D1		
SCE	Schlage / E		
SCC	Schlage / C		
SCC-K	Schlage / C-K		
SAL	Sargent / LA		
RA-RC	Sargent / RA-RC		
YA8	Yale / E1R		
GA	Yale / GA		
FAL	Falcon / E-R		
KW	Kwikset		
TA	PDQ / TA (Restricted. Limited to Grandmaster systems w/4 masters)		
Dummy	—		
T-Turn	—		
L	Less Cylinder		Deduct \$4.00
<b>HIGH SECURITY CYLINDERS AND CORES</b>			
SEE HIGH SECURITY CYLINDERS AND CORES SECTION, PAGE 118.			

- NOTES:**
- Specify finish for cylinders ordered separately
  - Kwikset cylinder available in 5 pin only
  - Specify KD, KA4, or 1 bitted
  - 6 pin cylinder keyed for 5 pin

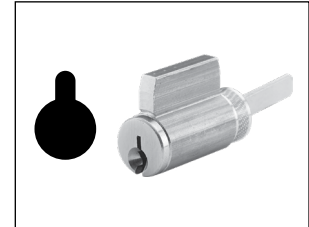

Key in Knob/Lever Cylinder

SX SERIES  
CYLINDRICAL LOCKS

### Cores and Keyways

DESCRIPTION	PDQ NO.	ADD
<b>SMALL FORMAT UNCOMBINATED</b>		
6 Pin Cores	I5206 + KEYWAY	\$40.00
7 Pin Cores	I5207 + KEYWAY	
<b>COMBINATED</b>		
6 Pin Cores	I5206-1 + KEYWAY	\$60.00
7 Pin Cores	I5207-1 + KEYWAY	
<b>BEST<sup>™</sup> Compatible</b>		
A (DEFAULT), B, C, D, E, F, G, H, J, K, L, M, Q,		
WA, WB, WC, WG, WH, TB, TD, TE, & R		
<b>PDQ Exclusive</b>		
PDQ1, PDQ2		
<b>PDQ Exclusive and Restricted</b>		
PDQ3		
<b>SFIC CONSTRUCTION</b>		
Construction Core 6-pin only		\$60.00
Dummy Construction Core Plastic		\$8.00
<b>HIGH SECURITY IC CORES</b>		
SEE HIGH SECURITY CYLINDERS AND CORES SECTION, PAGE 118. — LFIC REQUIRES LARGE FORMAT LEVER		

- NOTES:**
- Specify finish for IC Cores ordered separately
  - Control keys must be ordered separately
  - **PDQ1, PDQ2, PDQ3 (Restricted)**, Best A2 & A4 Systems Available

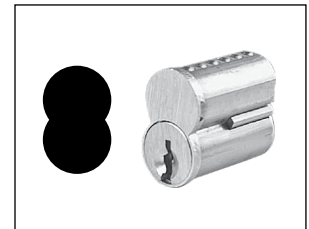

SFL/SFIC Core



UL 437 and High Security Cylinders





### Options

CODE	DESCRIPTION	LOCK ADJUSTMENT
<b>DB</b>	Dust Box	\$8.00
<b>AM</b>	Antimicrobial Coating, Knob Set Includes Inside and Outside Knob and Rose	\$37.00

### Backset

CODE	TYPE	FACEPLATE	CORNERS	PDQ NUMBER	LIST PRICE	
<b>2-3/4" BACKSET</b>						
234F	SPRINGLATCH	2-1/4" X 1	SQUARE	V21900-714	\$68.00	
234		2-1/4" X 1-1/8"	SQUARE (DEFAULT)	V21900-712		
234F	DEADLATCH	2-1/4" X 1	SQUARE	V21900-713		
234		2-1/4" X 1-1/8"	SQUARE (DEFAULT)	V21900-711		
<b>2-3/8" BACKSET</b>						
238	SPRINGLATCH	2-1/4" X 1	SQUARE (DEFAULT)	V21900-722		
238F		2-1/4" X 1-1/8"	SQUARE	V21900-724		
238R		2-1/4" X 1	1/4" RADIUS	V21900-722R		
238	DEADLATCH	2-1/4" X 1	SQUARE (DEFAULT)	V21900-721		
238F		2-1/4" X 1-1/8"	SQUARE	V21900-723		
238R		2-1/4" X 1	1/4" RADIUS	V21900-721R		
<b>3-3/4" BACKSET EXTENSION</b>						
Extension for 2-3/8" latch (sold separately) to make 3-3/4" Backset.				V21903	\$55.00	
<b>5" BACKSET EXTENSION</b>						
Extension for 2-3/4" latch (sold separately) to make 5" Backset.				V21902	\$58.00	

### Strikes

	CODE	DESCRIPTION	630	LIST PRICE
	ASA	ASA Strike (any finish) 1-1/4" x 4-7/8"	V91900-1	\$38.00
	T	T-Strike (any finish) 1-1/8" x 2-3/4"	V91901-1	\$17.00
	FL	Full Lip Strike (any finish) 1-5/8" x 2-1/4"	V919010-1	\$14.00
		MOUNTING SCREW PACK	X91910	\$12.00
		LATCHBOLT — 2-3/4" DEADLOCKING 2-1/4" X 1-1/8"	I04521-1	\$130.00
		LATCHBOLT — 2-3/8" DEADLOCKING 2-1/4" X 1-1/8"	V91904-721	\$115.00



## Durability and Reliability

PDQ's Grade 2 mechanical lock offering includes a range of features, functions, and styles as well as a commitment to deliver durability, convenience, and unmatched value for a wide range of projects and applications.

---

### GP Mechanical

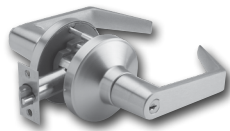

#### Applications

Heavy-duty performance for high-traffic interior and exterior applications including offices, hospitality, assisted living, church, and other high/medium duty commercial applications. Strong like an ox, over 3x BHMA abusive lever torque test standard.

---

### SD Mechanical

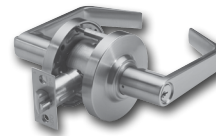

#### Applications

Built to offer tough and reliable performance at a competitive price. Applications include multi-family, offices, hospitality, assisted living, and other standard duty commercial applications.

---

### CL Interconnected Mechanical



#### Applications

Offers the security of a deadbolt and lever combined in one product. Applications include hospitality, assisted living, multi-family, offices and retail.

---

### SF Mechanical



#### Applications

Built to offer tough and reliable performance at a competitive price. Applications include multi-family, offices, hospitality, assisted living, and other standard duty commercial applications.



ASSEMBLED  
IN THE USA

## Typical Applications

- Government Facilities
- Healthcare
- Higher Education
- Hospitality
- Houses of Worship
- Industrial
- K-12 Education
- Multi-family
- Offices
- Public Buildings

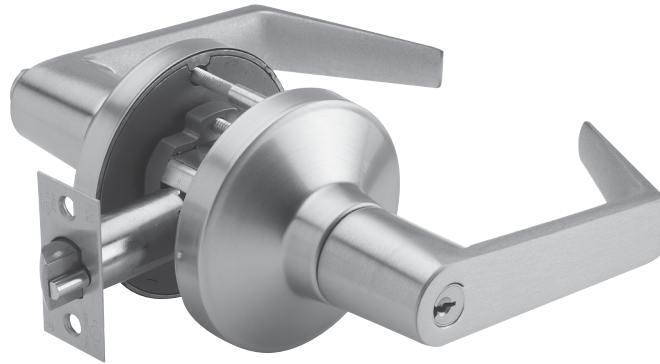

## Specifications



<b>FOR DOORS:</b>	• 1-3/8" to 1-3/4" thick • Preset for 1-3/4" door
<b>APPLICATION:</b>	• Through door thru-bolting • Fits 160 and 161 Door prep
<b>BACKSET:</b>	• 2-3/4" standard • 2-3/8", 3-3/4", 5" optional
<b>CHASSIS:</b>	• Heavy duty diecast, investment cast, cold rolled steel, stainless steel mechanism
<b>FRONT:</b>	• 2-1/4" x 1-1/8" or 2-1/4" x 1" • Stainless Steel or Wrought Brass • Beveled 1/8" on 2"
<b>STRIKE:</b>	• ASA standard • Stainless Steel or Wrought Brass • T-Strike or Full Lip Strike optional
<b>LEVERS:</b>	Philadelphia (SFL and LFL), Boston (SFL), Miami (SFL)
<b>ROSE:</b>	• 3-3/8" DIA Wrought
<b>LATCHBOLT:</b>	• 1/2" Throw
<b>HAND:</b>	• Non-handed
<b>TRIM:</b>	• Solid diecast PHL, BSN or MIA Levers • 65° Lever Rotation • Wrought Brass Roses • Concealed Screws
<b>KEYS:</b>	• Two (2) per Lock
<b>KEYWAYS:</b>	• SCC standard (Schlage C Compatible) • Compatible with Best, Falcon and Arrow small format IC cores
<b>INTERCHANGEABLE CORE:</b>	• Available for all keyed functions • Large Format IC Core available for PHL Lever ONLY. • 6 or 7-pin • Compatible with Best, Falcon & Arrow
<b>CYLINDER:</b>	• 6-pin Brass Insert Cylinder keyed to 5-pins • Standard High Security and UL437 Cylinders Available
<b>KEYING:</b>	• Options: MK, CMK or GMK • Zero Bitted (KO), Keyed Different (KD) or Keyed Alike (KA) Can be keyed into existing master key systems
<b>FINISHES:</b>	• 605 (US3), 606 (US4), 612 (US10), 613E, 619 (US15), 622 (US19), 625 (US26), 626 (US26D) • Optional Antimicrobial Coating Available with 626 finish only
<b>CERTIFICATIONS, LISTINGS, COMPLIANCES:</b>	• UL listed for 3 hrs, for single doors up to 4'0" x 8'0" • Certified to ANSI/BHMA 156.2, Grade 2 • Complies with ADA (Americans with Disabilities Act) and ICC/ANSI 117.1 for Accessible and Usable Buildings
<b>WARRANTY:</b>	• Eight (8) Year Limited Warranty
<b>COUNTRY OF ORIGIN:</b>	• Assembled in the U.S.A. with U.S. and foreign material. • Meets requirements of the Buy American Act as a COTS product manufactured in the United States.

† Available with antimicrobial coating, technology that is known to inhibit the growth of microbes.

### How to Order

QUANTITY	SERIES	FUNCTION	LEVER	FINISH	BACKSET	STRIKE	CYLINDER	KEYWAY	KEYING	OPTION						
6	GP	116	PHL	626	234	ASA	D	SCC	KD	—						
			BSN MIA PHL	605	234 —	ASA — ANSI/ ASA (default)	D Default L Less Cylinder SF6 Lock is SFIC prepped w/ 6 pin core SF7 Lock is SFIC prepped w/ 7 pin core SFL Lock is SFIC prepped but less core SFC Lock is SFIC prepped w/ construction core SFP Lock is SFIC prepped w/ plastic construction core LF6 Lock is Schlage LFIC prepped w/ Schlage core LFL Lock is Schlage LFIC prepped but less core LFC Lock is Schlage LFIC prepped w/ construction core	PAGE 67		TC1IS — Tactile Abrasive Coating - Inside only TC1OS — Tactile Abrasive Coating - Outside only TC2 — Tactile Abrasive Coating - Both Sides SF — Split Finishes LL — Lead-Lined Rose DB — Dust Box AM — Antimicrobial Coating W — Weatherized (626 Only)						
				606	2-3/4"						612	2-3/8"	613E	3-3/4"	619	5 — 5"

NOTE: Case quantity is 6 / Case weight is 30 lbs. Keyed Functions / Case weight is 29 lbs. Non-Keyed Functions / For split finishes, designate O/S trim first, then I/S

### Locksets - Standard and Interchangeable Cores

ANSI NO.	FUNCTION	DESCRIPTION	626	605/606/612 613E/619/622/625
<b>NON-CYLINDER</b>				
	125	Communicating	\$186.00	\$208.00
F75	126	Passage		
F76	176	Privacy	\$217.00	\$239.00
<b>SINGLE CYLINDER</b>				
F86	115	Store Room	\$234.00	\$256.00
F109	116	Entrance		
F84	148	Classroom		
	150	Exit / Twin Communicating		
F82	182	Office / Entry		
<b>DUMMY</b>				
	205	Double Dummy	\$142.00	\$164.00
	211	Single Dummy	\$81.00	\$92.00

List prices shown include cylinder.

CYLINDER OPTIONS	ICON	LOCK ADJUSTMENT
D		
SFL		N/C
LFL*		

IC Core not included see page 67 for core option  
LFL prep only available in PHL lever and 613E, 622, 626 finish.

### Trim/Levers



ALL LEVERS

### NOTES:

- Locks will be furnished with 2-3/4" Latchbolt, ASA Strike & SCC Keyway unless otherwise stated
- 2-3/4" Latchbolt will be furnished with 2-1/4" x 1-1/8" faceplate unless otherwise stated
- 2-3/8" Latchbolt will be furnished with 2-1/4" x 1" faceplate unless otherwise stated
- Split finishes priced at the highest finish price

### Backset

CODE	DESCRIPTION	LOCK ADJUSTMENT
	<b>2-3/4" BACKSET</b>	N/C
234	2-1/4" x 1-1/8"	
234F	2-1/4" x 1"	
	<b>2-3/8" BACKSET</b>	
238F	2-1/4" x 1-1/8"	\$5.00
238	2-1/4" x 1"	
238R	2-1/4" x 1" x 1/4" Radius	
	<b>3-3/4" BACKSET</b>	\$18.00
334F	2-1/4" x 1-1/8"	
334	2-1/4" x 1"	
334R	2-1/4" x 1" x 1/4" Radius	
	<b>5" BACKSET</b>	\$24.00
5	2-1/4" x 1-1/8"	
5F	2-1/4" x 1"	
5FR	2-1/4" x 1" x 1/4" Radius	

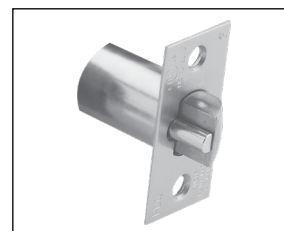

### Strikes

	CODE	DESCRIPTION	LOCK ADJUSTMENT
	ASA	ASA Strike (any finish) 1-1/4" x 4-7/8"	N/C
	T	T-Strike (any finish) 1-1/8" x 2-3/4"	
	FL	Full Lip Strike (any finish) 1-5/8" x 2-1/4"	

NOTES:  
 • Specify finish for Strikes & Latchbolts if ordered separately

## Keyways and Cylinders

PDQ KEYWAY	COMPATIBLE WITH	SOLD WITH LOCK	
AR1	Arrow / AR1	N/C	
CO59A1	Corbin / 59A1		
CO6	Corbin / 60		
CL4	Corbin / L4		
RUD	Russwin / D1		
SCE	Schlage / E		
SCC	Schlage / C		
SCC-K	Schlage / C-K		
SAL	Sargent / LA		
RA-RC	Sargent / RA-RC		
YA8	Yale / E1R		
GA	Yale / GA		
FAL	Falcon / E-R		
KW	Kwikset		
TA	PDQ / TA (Restricted. Limited to Grandmaster systems w/4 masters)		
Dummy	—		
T-Turn	—		
L	Less Cylinder		Deduct \$4.00
<b>HIGH SECURITY CYLINDERS AND CORES</b>			
SEE HIGH SECURITY CYLINDERS AND CORES SECTION, PAGE 118			

**NOTES:**

- Specify finish for cylinders ordered separately
- Kwikset cylinder available in 5 pin only
- Specify KD, KA4, or 1 bitted
- 6 pin cylinder keyed for 5 pin

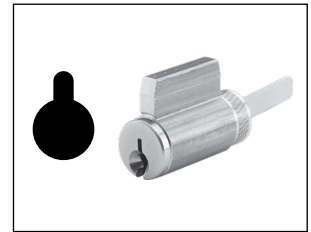

Key in Knob/Lever Cylinder



UL 437 and High Security Cylinders

## Cores and Keyways

DESCRIPTION	PDQ NO.	ADD
<b>SMALL FORMAT UNCOMBINED</b>		
6 Pin Cores	I5206 + KEYWAY	\$40.00
7 Pin Cores	I5207 + KEYWAY	
<b>COMBINED</b>		
6 Pin Cores	I5206-1 + KEYWAY	\$60.00
7 Pin Cores	I5207-1 + KEYWAY	
<b>BEST<sup>™</sup> Compatible</b>		
A (DEFAULT), B, C, D, E, F, G, H, J, K, L, M, Q, WA, WB, WC, WG, WH, TB, TD, TE, & R		
<b>PDQ Exclusive</b>		
PDQ1, PDQ2		
<b>PDQ Exclusive and Restricted</b>		
PDQ3		
<b>SFIC CONSTRUCTION</b>		
Construction Core 6-pin only		\$60.00
Dummy Construction Core Plastic		\$8.00
<b>LFIC CONSTRUCTION</b>		
Construction Core 6-pin only. <b>Construction cores are invoiced at shipment and credited upon return.</b>		\$70.00
IC Tailpiece Assembly		\$10.00
<b>LFIC COMBINED</b>		
Schlage compatible LFIC, SCC (Schlage C compatible) keyway		\$70.00
PDQ TA LFIC Restricted		
<b>LFIC UNCOMBINED</b>		
Schlage compatible LFIC, SCC (Schlage C compatible) keyway		\$50.00
<b>HIGH SECURITY IC CORES</b>		
SEE HIGH SECURITY CYLINDERS AND CORES SECTION, PAGE 118. — LFIC REQUIRES LARGE FORMAT LEVER		

**NOTES:**

- Combined cores include master keying in the list price
- Specify finish for IC Cores ordered separately
- Control keys must be ordered separately
- **PDQ1, PDQ2, PDQ3 (Restricted)**, Best A2 & A4 Systems Available

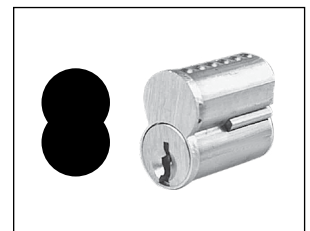

SFL/SFIC Core

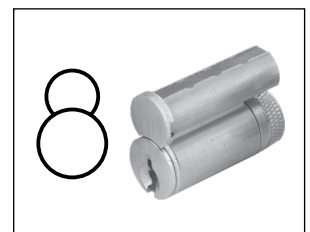

LFL/LFIC Schlage Format

### Options







CODE	DESCRIPTION	LOCK ADJUSTMENT
<b>TC1IS</b>	Tactile Abrasive Coating - Inside only	\$26.00
<b>TC1OS</b>	Tactile Abrasive Coating - Outside only	
<b>TC2</b>	Tactile Abrasive Coating - Both Sides	\$52.00
<b>SF</b>	Split Finishes	Higher Finish Price
<b>LL</b>	Lead-Lined Rose	\$214.00
<b>DB</b>	Dust Box	\$8.00
<b>AM</b>	Antimicrobial Coating, Lever Set Includes Inside and Outside Lever and Rose (Available with 626 finish only)	\$40.00
<b>W</b>	Weatherized Finish - 626 Only	\$80.00

CODE	TYPE	FACEPLATE	CORNERS	PDQ NUMBER	LIST PRICE	
<b>2-3/4" BACKSET</b>						
234F	SPRINGLATCH	2-1/4" X 1	SQUARE	V21900-714	\$68.00	
234		2-1/4" X 1-1/8"	SQUARE (DEFAULT)	V21900-712		
234F	DEADLATCH	2-1/4" X 1	SQUARE	V21900-713		
234		2-1/4" X 1-1/8"	SQUARE (DEFAULT)	V21900-711		
<b>2-3/8" BACKSET</b>						
238	SPRINGLATCH	2-1/4" X 1	SQUARE (DEFAULT)	V21900-722		
238F		2-1/4" X 1-1/8"	SQUARE	V21900-724		
238R		2-1/4" X 1	1/4" RADIUS	V21900-722R		
238	DEADLATCH	2-1/4" X 1	SQUARE (DEFAULT)	V21900-721		
238F		2-1/4" X 1-1/8"	SQUARE	V21900-723		
238R		2-1/4" X 1	1/4" RADIUS	V21900-721R		
<b>3-3/4" BACKSET EXTENSION</b>						
Extension for 2-3/8" latch (sold separately) to make 3-3/4" Backset.				V21903	\$55.00	
<b>5" BACKSET EXTENSION</b>						
Extension for 2-3/4" latch (sold separately) to make 5" Backset.				V21902		

## Strikes

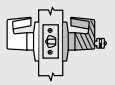
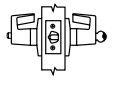
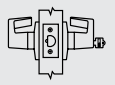
	CODE	DESCRIPTION	605	613E	622	630	LIST PRICE
	ASA	ASA Strike (any finish) 1-1/4" x 4-7/8"	V91900-5	V91900-6	V91900-H	V91900-1	\$38.00
	T	T-Strike (any finish) 1-1/8" x 2-3/4"	V91901-5	V91901-6	V91901-H	V91901-1	\$17.00
	FL	Full Lip Strike (any finish) 1-5/8" x 2-1/4"	V919010-5	V919010-6	V919010-H	V919010-1	\$14.00

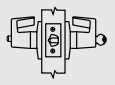
## PDQ Functions

FUNCTION	FUNCTION NUMBER	INSIDE   OUTSIDE	DESCRIPTION	ANSI NUMBER
<b>NON KEYED</b>				
Communicating	GP125		<ul style="list-style-type: none"> <li>Latchbolt operated by inside lever</li> <li>Blank plate outside</li> <li>Minimum clearance of 1-1/2" between doors</li> <li>Frame depth 7-1/8"</li> <li>Deadlocking (guarded) latchbolt</li> </ul>	—
Passage	GP126		<ul style="list-style-type: none"> <li>Latchbolt operated by lever from either side at all times</li> </ul>	F75
Privacy Bedroom Bathroom	GP176		<ul style="list-style-type: none"> <li>Latchbolt operated by lever from either side or emergency release in outside lever</li> <li>Outside lever locked by push button on inside</li> <li>Outside lever unlocked by emergency release from outside, rotating inside lever, or closing door</li> </ul>	F76
<b>KEYED</b>				
Storeroom	GP115		<ul style="list-style-type: none"> <li>Latchbolt operated by inside lever or key in outside lever</li> <li>Outside lever always fixed</li> </ul>	F86
Entrance	GP116		<ul style="list-style-type: none"> <li>Latchbolt operated by lever from either side or key in outside lever</li> <li>Outside lever locked by push/turn button on inside</li> <li>When outside lever is locked by push button on inside – key from outside, or rotating inside lever unlocks outside lever</li> <li>When outside lever is locked by pushing and turning button on the inside, key from outside or rotating inside lever retracts latch but does not unlock outside lever</li> </ul>	F109
Classroom	GP148		<ul style="list-style-type: none"> <li>Latchbolt operated by lever from either side</li> <li>Outside lever locked by key from outside</li> <li>Outside lever unlocked by key from outside</li> <li>Inside lever always operates latch</li> </ul>	F84
Exit or Twin Communicating	GP150		<ul style="list-style-type: none"> <li>Latchbolt operated by inside lever</li> <li>Blank plate outside</li> <li>Inside lever locked by key inside</li> <li>Inside lever unlocked by key inside</li> <li>Minimum clearance of 1-1/2" between doors</li> <li>Use only in rooms with more than one exit</li> <li>Frame depth 7-1/8"</li> </ul>	—
Entry	GP182		<ul style="list-style-type: none"> <li>Latchbolt operated by lever from either side or key in outside lever</li> <li>Outside lever locked by push button on inside</li> <li>Outside lever unlocked by key from outside, and rotating inside lever</li> </ul>	F82
<b>DUMMY</b>				
Double Dummy	GP205		<ul style="list-style-type: none"> <li>Pull lever both sides</li> <li>No mechanical operation</li> </ul>	—
Single Dummy	GP211		<ul style="list-style-type: none"> <li>Pull lever one side</li> <li>No mechanical operation</li> </ul>	—

GP SERIES  
CYLINDRICAL LOCKS



INDICATES RIGID LEVER



## Cross Reference

ANSI # / FUNCTION	PDQ	ARROW	BEST	CORBIN	DORMA	FALCON	DORMA COMMERCIAL	SARGENT	SCHLAGE	ACCENTRA
F75 PASSAGE	GP 126	ML01	73K	CL3810	CL710	B101	QCL230	7U15	AL10	5301LN
F76 PRIVACY	GP 176	ML02	73K	CL3820	CL740	B301	QCL240	7U65	AL40	5303LN
F82 ENTRY	GP 182	NA	73K	CL3861	CL750	B501	NA	NA	AL50	5302LN
F109 ENTRANCE	GP 116	ML11	73K	CL3851	CL753	B511	QCL250	7G05	AL53	5307LN
F84 CLASSROOM	GP 148	ML17	73K	CL3855	CL770	B561	QCL260	7G37	AL70	5308LN
F86 STORE ROOM	GP 115	ML12	73K	CL3857	CL780	B581	QCL270	7G04	AL80	5305LN
SINGLE DUMMY	GP 211	ML08	73K	CL3850	CL701	B12	QCL220	7U93	AL170	5328LN

## Lever Comparison

PDQ	ARROW	BEST	CORBIN	DORMA	FALCON	DORMA COMMERCIAL	SARGENT	SCHLAGE	ACCENTRA
MIAMI — MIA	VR	16	AZD	LG	NA	SLA	B	JUP	MO
PHILADELPHIA — PHL	BRR	15	NZD	LR	D	PNN	L	SAT	AU
BOSTON — BSN	SR	14	PZD	LC	Q	PEA	P	NEP	PB



PHILADELPHIA — PHL



BOSTON — BSN



MIAMI — MIA

Information on this sheet is compiled from public documents and third parties. As a result, PDQ makes no guarantees as to their accuracy, content, quality or availability. Comparisons were made using the technical features only and are not commercial comparisons. Final suitability should be determined by a professional hardware consultant.

GP SERIES  
CYLINDRICAL LOCKS



## Typical Applications

- Assisted Living
- Hospitality
- Houses of Worship
- Industrial
- Medium/Light Commercial Installations
- Multi-family
- Offices
- Retail

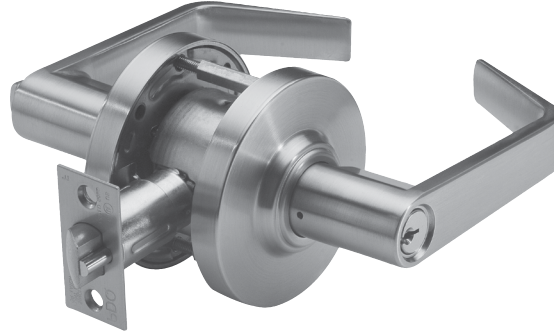

## Specifications



<b>FOR DOORS:</b>	• 1-3/8" to 1-3/4" thick • Preset for 1-3/4" door
<b>APPLICATION:</b>	• Through door thru-bolting • Fits standard 160 and 161 Door prep • Thru-Bolts are removable
<b>BACKSET:</b>	• 2-3/4" standard • 2-3/8", 3-3/4", 5" optional
<b>CHASSIS:</b>	• Heavy-gauge cold rolled steel mechanism • Dichromated for corrosion resistance
<b>FRONT:</b>	• 2-1/4" x 1-1/8" or 2-1/4" x 1" • Stainless Steel or Wrought Brass
<b>STRIKE:</b>	• ASA standard • T-Strike or Full Lip Strike optional • Stainless Steel or Wrought Brass
<b>LEVERS:</b>	• Philadelphia, Boston, Miami, Memphis, Orlando
<b>ROSE:</b>	• 3-3/8" DIA Wrought
<b>LATCHBOLT:</b>	• 1/2" Throw
<b>HAND:</b>	• Non-handed (Except Memphis)
<b>TRIM:</b>	• Solid diecast PHL, BSN, MIA, MEM and ORL Levers • Wrought Brass Roses • Concealed Screws
<b>KEYS:</b>	• Two (2) per Lock
<b>KEYWAYS:</b>	• SCC standard (Schlage C Compatible) • Also available in keyways of other manufacturers
<b>INTERCHANGEABLE CORE:</b>	• 6 or 7-pin • Compatible with Best, Falcon & Arrow. Not available with Memphis lever.
<b>CYLINDER:</b>	• 6-pin Brass Insert Cylinder keyed to 5-pins • Standard High Security and UL437 Cylinders Available
<b>KEYING:</b>	• Options: MK, CMK or GMK / Zero Bitted (KO), Keyed Different (KD) or Keyed Alike (KA) • Can be keyed into existing master key systems
<b>FINISHES:</b>	• 605 (US3), 613E, 622 (US19), 626 (US26D) †
<b>CERTIFICATIONS, LISTINGS, COMPLIANCES:</b>	• UL listed for 3 hrs, for single doors up to 4'0" x 8'0" • Certified to ANSI/BHMA A156.2 Grade 2 • Complies with ADA (Americans with Disabilities Act) and ICC/ANSI 117.1 for Accessible and Usable Buildings • TAA compliant. Country of origin: KR
<b>WARRANTY:</b>	• Five (5) year Limited Warranty

† Available with antimicrobial coating, technology that is known to inhibit the growth of microbes.

## How to Order

QUANTITY	SERIES	FUNCTION	LEVER	FINISH	BACKSET	STRIKE	CYLINDER	KEYWAY	KEYING	OPTION
10	SD	116	PHL	626	234	ASA	D	SCC	KD	—
NOTE: Case quantity is 10 / Case weight is 37 lbs. *Memphis keyed and dummy functions only.			BSN	605	234 —	ASA —	D Default	PAGE 75		SF — Split Finishes
			MIA	613E	2-3/4"	ANSI/	L Less Cylinder			DB — Dust Box
			PHL	622	238 —	ASA (de-	SF6 Lock is SFIC			
			MEM	626	2-3/8"	fault)	prepped w/ 6 pin			
			ORL		334 —	FL —	core			
					5 — 5"	Full Lip	SF7 Lock is SFIC			
						T —	prepped w/ 7 pin			
						"T" Strike	core			
							SFL Lock is SFIC			
							prepped but less			
							core			
							SFC Lock is SFIC			
							prepped w/			
							construction core			
							SFP Lock is SFIC			
							prepped w/ plastic			
							construction core			
										PAGE 76

## Locksets

ANSI NO.	FUNCTION	DESCRIPTION	626	605, 613E, 622
<b>NON-CYLINDER</b>				
	125	Communicating	\$118.00	\$127.00
F75	126	Passage		
F76	176	Privacy	\$122.00	\$131.00
<b>SINGLE CYLINDER</b>				
F86	115	Store Room	\$128.00	\$137.00
F109	116	Entrance		
F84	148	Classroom		
F82	182	Entry		
<b>DUMMY</b>				
	211	Single Dummy	\$64.00	\$69.00

List prices shown include cylinder.

CORE OPTIONS	ICON	LOCK ADJUSTMENT
D		N/C
SFL		N/C

IC Core not included see page 75 for core options.

**NOTES:**

- Locks will be furnished with 2-3/4" Latchbolt, ASA Strike & SCC Cylinder unless otherwise stated
- 2-3/4" Latchbolt will be furnished with 2-1/4" x 1-1/8" faceplate unless otherwise stated
- 2-3/8" Latchbolt will be furnished with 2-1/4" x 1" faceplate unless otherwise stated

SD SERIES  
CYLINDRICAL LOCKS

## Trim/Levers



CODE	DESCRIPTION	LOCK ADJUSTMENT
<b>2-3/4" BACKSET</b>		
234	2-1/4" x 1-1/8"	N/C
234F	2-1/4" x 1"	
234FR	2-1/4" x 1" x 1/4" Radius	
<b>2-3/8" BACKSET</b>		
238F	2-1/4" x 1-1/8"	N/C
238	2-1/4" x 1"	
238R	2-1/4" x 1" x 1/4" Radius	
<b>3-3/4" BACKSET</b>		
334F	2-1/4" x 1-1/8"	\$18
334	2-1/4" x 1"	
334R	2-1/4" x 1" x 1/4" Radius	
<b>5" BACKSET</b>		
5	2-1/4" x 1-1/8"	\$24
5F	2-1/4" x 1"	
5FR	2-1/4" x 1" x 1/4" Radius	

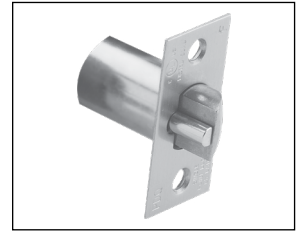

## Strikes

	CODE	DESCRIPTION	LOCK ADJUSTMENT
	ASA	ASA Strike (any finish) 1-1/4" x 4-7/8"	N/C
	T	T-Strike (any finish) 1-1/8" x 2-3/4"	
	FL	Full Lip Strike (any finish) 1-5/8" x 2-1/4"	

### NOTES:

- Specify finish for Strikes & Latchbolts if ordered separately

### Keyways and Cylinders

PDQ KEYWAY	COMPATIBLE WITH	SOLD WITH LOCK
AR1	Arrow / AR1	N/C
CO59A1	Corbin / 59A1	
CO6	Corbin / 60	
CL4	Corbin / L4	
RUD	Russwin / D1	
SCE	Schlage / E	
SCC	Schlage / C	
SCC-K	Schlage / C-K	
SAL	Sargent / LA	
RA-RC	Sargent / RA-RC	
YA8	Yale / E1R	
GA	Yale / GA	
FAL	Falcon / E-R	
KW	Kwikset	
TA	PDQ / TA (Restricted. Limited to Grandmaster systems w/4 masters)	
Dummy	—	
T-Turn	—	
L	Less Cylinder	
<b>HIGH SECURITY CYLINDERS AND CORES</b>		
SEE HIGH SECURITY CYLINDERS AND CORES SECTION, PAGE 118		

**NOTES:**

- Specify finish for cylinders ordered separately
- Kwikset cylinder available in 5 pin only
- Specify KD, KA4, or 1 bitted
- 6 pin cylinder keyed for 5 pin

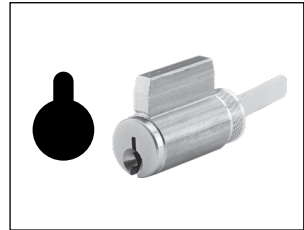

Key in Knob/Lever Cylinder



UL 437 and High Security Cylinders

### Cores and Keyways

DESCRIPTION	PDQ NO.	ADD
<b>SMALL FORMAT UNCOMBINED</b>		
6 Pin Cores	I5206 + KEYWAY	\$40.00
7 Pin Cores	I5207 + KEYWAY	
<b>COMBINED</b>		
6 Pin Cores	I5206-1 + KEYWAY	\$60.00
7 Pin Cores	I5207-1 + KEYWAY	
<b>BEST Compatible</b>		
A (DEFAULT), B, C, D, E, F, G, H, J, K, L, M, Q, WA, WB, WC, WG, WH, TB, TD, TE, & R		
<b>PDQ Exclusive</b>		
PDQ1, PDQ2		
<b>PDQ Exclusive and Restricted</b>		
PDQ3		
<b>SFIC CONSTRUCTION</b>		
Construction Core 6-pin only		\$60.00
Dummy Construction Core Plastic		\$8.00
<b>LFIC CONSTRUCTION</b>		
Construction Core 6-pin only		\$70.00
<b>IC Tailpiece Assembly Construction cores are invoiced at shipment and credited upon return.</b>		\$10.00
<b>HIGH SECURITY IC CORES</b>		
SEE HIGH SECURITY CYLINDERS AND CORES SECTION, PAGE 118		

**NOTES:**

- Specify finish for IC Cores ordered separately
- Control keys must be ordered separately
- **PDQ1, PDQ2, PDQ3 (Restricted)**, Best A2 & A4 Systems Available

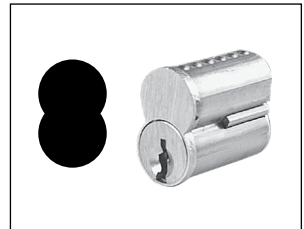

SFL/SFIC Core

**SD SERIES**  
CYLINDRICAL LOCKS



### Options

CODE	DESCRIPTION	LOCK ADJUSTMENT
SF	Split Finishes	\$8.00
DB	Dust Box	\$8.00









### Backset

CODE	TYPE	FACEPLATE	CORNERS	PDQ NUMBER	LIST PRICE	
<b>2-3/4" BACKSET</b>						
234F	SPRINGLATCH	2-1/4" X 1	SQUARE	V21900-714	\$68.00	
234		2-1/4" X 1-1/8"	SQUARE (DEFAULT)	V21900-712		
234F	DEADLATCH	2-1/4" X 1	SQUARE	V21900-713		
234		2-1/4" X 1-1/8"	SQUARE (DEFAULT)	V21900-711		
<b>2-3/8" BACKSET</b>						
238	SPRINGLATCH	2-1/4" X 1	SQUARE (DEFAULT)	V21900-722		
238F		2-1/4" X 1-1/8"	SQUARE	V21900-724		
238R		2-1/4" X 1	1/4" RADIUS	V21900-722R		
238	DEADLATCH	2-1/4" X 1	SQUARE (DEFAULT)	V21900-721		
238F		2-1/4" X 1-1/8"	SQUARE	V21900-723		
238R		2-1/4" X 1	1/4" RADIUS	V21900-721R		
<b>3-3/4" BACKSET EXTENSION</b>						
Extension for 2-3/8" latch (sold separately) to make 3-3/4" Backset.				V21903	\$55.00	
<b>5" BACKSET EXTENSION</b>						
Extension for 2-3/8" latch (sold separately) to make 5" Backset.				V21902		

### Strikes

	CODE	DESCRIPTION	605	613E	622	630	LIST PRICE
	ASA	ASA Strike (any finish) 1-1/4" x 4-7/8"	V91900-5	V91900-6	V91900-H	V91900-1	\$38.00
	T	T-Strike (any finish) 1-1/8" x 2-3/4"	V91901-5	V91901-6	V91901-H	V91901-1	\$17.00
	FL	Full Lip Strike (any finish) 1-5/8" x 2-1/4"	V919010-5	V919010-6	V919010-H	V919010-1	\$14.00

## PDQ Functions

FUNCTION	FUNCTION NUMBER	INSIDE   OUTSIDE	DESCRIPTION	ANSI NUMBER
<b>NON KEYED</b>				
Communicating	SD125		<ul style="list-style-type: none"> <li>Latchbolt operated by inside lever</li> <li>Blank plate outside</li> <li>Minimum clearance of 1-1/2" between doors</li> <li>Deadlocking (guarded) latchbolt</li> </ul>	—
Passage	SD126		<ul style="list-style-type: none"> <li>Latchbolt operated by lever from either side at all times</li> </ul>	F75
Privacy Bedroom Bathroom	SD176		<ul style="list-style-type: none"> <li>Latchbolt operated by lever from either side or emergency release in outside lever</li> <li>Outside lever locked by push button on inside</li> <li>Outside lever unlocked by emergency release from outside, rotating inside lever, or closing door</li> </ul>	F76
<b>KEYED</b>				
Storeroom	SD115		<ul style="list-style-type: none"> <li>Latchbolt operated from outside by key, inside by lever</li> <li>Outside lever always fixed</li> <li>Inside lever always free</li> <li>Deadlocking (guarded) latchbolt</li> </ul>	F86
Entrance	SD116		<ul style="list-style-type: none"> <li>Latchbolt operated by lever from either side or key in outside lever</li> <li>Outside lever locked by push/turn button on inside or rotating inside lever unlocks outside lever</li> <li>When outside lever is locked by push button on inside – key from outside, or rotating inside lever unlocks outside lever</li> <li>When outside lever is locked by pushing and turning the button on the inside, key from outside or rotating inside lever retracts latch but does not unlock outside lever</li> <li>Deadlocking (guarded) latchbolt</li> </ul>	F109
Classroom	SD148		<ul style="list-style-type: none"> <li>Latchbolt operated by lever from either side</li> <li>Outside lever locked or unlocked by key from outside</li> <li>Inside lever always operates latch</li> <li>Deadlocking (guarded) latchbolt</li> </ul>	F84
Entry	SD182		<ul style="list-style-type: none"> <li>Latchbolt operated by lever from either side or key in outside lever</li> <li>Outside lever locked by push button on inside</li> <li>Outside lever unlocked by key from outside, and rotating inside lever</li> </ul>	F82
<b>DUMMY</b>				
Single Dummy	SD211		<ul style="list-style-type: none"> <li>Pull lever one side</li> <li>No mechanical operation</li> </ul>	—



INDICATES RIGID LEVER



## Cross Reference

ANSI # / FUNCTION	PDQ	ARROW	CAL ROYAL	CORBIN	DORMA	FALCON	HAGER	SARGENT	ACCENTRA
F75 PASSAGE	SD 126	RL01	SL30	CL3710	C510	W101	2510	6U15	4601LN
F76 PRIVACY	SD 176	RL02	SL20	CL3720	C540	W301	2540	6U65	4602LN
F109 ENTRANCE	SD 116	RL11	SL01	CL3751	C553	W511	2553	65G37	4607LN
F84 CLASSROOM	SD 148	RL17	SL03	CL3755	C570	W561	2570	6G37	4608LN
F86 STORE ROOM	SD 115	RL12	SL05	CL3759	C580	W581	2580	6G04	4605LN
SINGLE DUMMY	SD 211	RL08	SL40	CL3750	C501	W12	2517	6U93	4655LN

## Lever Cross Reference

PDQ	ARROW	CAL ROYAL	CORBIN	DORMA	FALCON	HAGER	SARGENT	ACCENTRA
MIAMI — MIA		AG	AZD	LG			B	MO
PHILADELPHIA — PHL	BRR	GN	NZD	LR	D	WTS	L	AU
BOSTON — BSN	SR	SPA	PZD	LC	Q	ARC	P	PB
MEMPHIS — MEM								
ORLANDO — ORL								



PHILADELPHIA — PHL



BOSTON — BSN



MIAMI — MIA



MEMPHIS — MEM  
(SPECIFY HANDING)



ORLANDO — ORL

Information on this sheet is compiled from public documents and third parties. As a result, PDQ makes no guarantees as to their accuracy, content, quality or availability. Comparisons were made using the technical features only and are not commercial comparisons. Final suitability should be determined by a professional hardware consultant.



## Reliable Security for Multi-Family, Multi-Tenant and Light Commercial Applications.

- 5 functions - Privacy, Passage, Entrance Storeroom plus Single Dummy
- Heavier duty cylindrical lock is more durable than a tubular lock
- 5 designer levers to choose from
- 7 architectural finishes
- Stylish 2-9/16" round rose and 2-15/16" square rose
- Retrofits all major manufacturer's door preps
- Adjustable 2-3/8" – 2-3/4" backset latch is standard.
- Optional fixed backset latch adds fire label and BHMA certification.
- Conventional and SFIC core cylinders.
- Anti-lockout kick-off feature (Privacy)
- Suitable for doors 1-3/8" – 1-3/4" thick
- Shares common levers with SD Cylindrical and CL Interconnected locks. Mix and match for a uniform look.

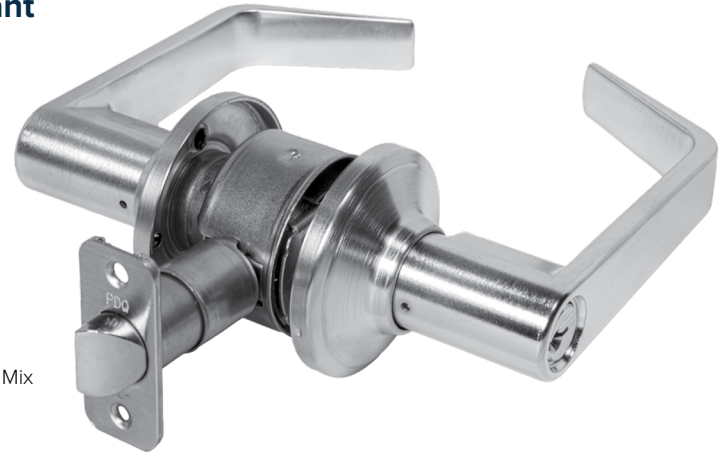

## Applications



MULTI-FAMILY HOUSING



SENIOR LIVING



STUDENT HOUSING



LIGHT COMMERCIAL

## Specifications



<b>FOR DOORS:</b>	• 1-3/8" to 1-3/4" thick • Preset for 1-3/4" door
<b>APPLICATION:</b>	• Fits standard 160 and 161 door prep • No additional thru-bolt
<b>BACKSET:</b>	• Adjustable - 2-3/8" - 2-3/4" (Optional UL Listed fire latch has fixed backsets, 2-3/8" or 2-3/4")
<b>CHASSIS:</b>	• Heavy-gauge cold rolled steel mechanism • Dichromated for corrosion resistance
<b>FRONT:</b>	• 1" face width, 1/4" radius with square corner filler for 1-1/8" width.
<b>STRIKE:</b>	• Full Lip Strike standard, ASA and T-Strike optional
<b>LEVERS:</b>	• Philadelphia, Boston, Miami, Memphis and Orlando
<b>ROSE:</b>	• 2-9/16" Diameter Round Rose, 2-15/16" Square Rose
<b>LATCHBOLT:</b>	• Adjustable - 2-3/8" - 2-3/4" latch standard for Non-Keyed functions, with optional UL fire-rated 2-3/4" or 2-3/8" fixed backset. • Fixed backset 2-3/8" or 2-3/4" latchbolt standard for Keyed functions.
<b>HAND:</b>	• Non-handed
<b>TRIM:</b>	• Solid diecast PHL, BSN, MIA, MEM and ORL levers • Wrought brass roses • Concealed screws
<b>KEYS:</b>	• Two (2) per Lock
<b>KEYWAYS:</b>	• SCC standard (Schlage C Compatible) • Also available in keyways of other manufacturers
<b>INTERCHANGEABLE CORE:</b>	• 6 or 7-pin • Compatible with Best, Falcon & Arrow. Not available with Memphis lever.
<b>CYLINDER:</b>	• 6-pin Brass Insert Cylinder keyed to 5-pins • Standard High Security and UL437 Cylinders Available
<b>KEYING:</b>	• Options: MK, CMK or GMK / Zero Bitted (KO), Keyed Different (KD) or Keyed Alike (KA) • Can be keyed into existing master key systems
<b>FINISHES:</b>	• 605 (US3), 606 (US4), 613E, 619 (US15), 622 (US19), 625 (US26), 626 (US26D)
<b>CERTIFICATIONS, LISTINGS, COMPLIANCES:</b>	• Entry function and optional fixed backset latch only. – Certified to ANSI/BHMA 156.2, Grade 2 (fixed backset latch only). – UL listed for single doors up to 4'0" x 8'0" when ordered with UL latchbolt, contact factory for details. • Complies with ADA (Americans with Disabilities Act) and ICC/ANSI 117.1 for Accessible and Usable Buildings • TAA compliant. Country of origin: KR
<b>WARRANTY:</b>	• Three (3) year Limited Warranty

# SF SERIES

**LIST PRICE**

## How to Order - Non-Keyed Functions

Effective July 3, 2023

SERIES	FUNCTION	LEVER	ROSE	FINISH	LATCH	STRIKE	OPTION
SF	126	PHL	—	626	ADJ	FL	—
	126 — Passage	BSN	BLANK — Round Rose (default) All Levers	605	ADJ* — Non-Fire Rated 1" face width, 1/4" radius corner with 1-1/8" square corner filler.	FL — Full Lip (default)	SF — Split Finishes
	176 — Privacy	MIA		606	234** — Fire Rated Fixed 2-3/4" backset fire rated latch, Square Corner 1-1/8" face	ASA — ANSI/ASA	
	211 — Single Dummy	MEM*		613E	238** — Fire Rated Fixed 2-3/8" backset fire rated latch, Square Corner 1" face	T — "T" Strike	
		ORL	SR — Square Rose (All Levers)	619	238R** — Fire Rated Fixed 2-3/8" backset fire rated latch, Radius Corner 1" face		
		PHL		622			
			625				
			626				

\*ADJ latch is standard.

\*\*Optional fixed backset latch adds fire label and BHMA Certification.

PAGE 82

PAGE 82

## How to Order - Keyed Functions

SERIES	FUNCTION	LEVER	ROSE	FINISH	LATCH	STRIKE	CYLINDER	KEYWAY	KEYING	OPTION
SF	116	PHL	—	626	234	FL	D	SCC	KD	—
	115 — Storeroom	BSN	BLANK — Round Rose (default) All Levers	605	234* — Fire Rated Fixed 2-3/4" backset fire rated latch, Square Corner 1-1/8" face	FL — Full Lip (default)	D Default	PAGE 83		SF — Split Finishes
	116 — Entrance	MIA		606	238* — Fire Rated Fixed 2-3/8" backset fire rated latch, Square Corner 1" face	ASA — ANSI/ASA	L Less Cylinder			
		MEM**	SR — Square Rose (All Levers)	613E	238R* — Fire Rated Fixed 2-3/8" backset fire rated latch, Radius Corner 1" face	T — "T" Strike	SF6 Lock is SFIC prepped w/ 6 pin core			
		ORL		619			SF7 Lock is SFIC prepped w/ 7 pin core			
		PHL		622			SFL Lock is SFIC prepped but less core			
			625				SFC Lock is SFIC prepped w/ construction core			
			626				SFP Lock is SFIC prepped w/ plastic construction core			

\*Fire rated, fixed backset latch is standard on keyed functions.

\*\*Memphis not available w/SFIC

PAGE 82

PAGE 83

PAGE 82

## Locksets

ANSI NO.	FUNCTION	DESCRIPTION	626/619	605, 606, 613E, 622, 625
<b>NON-CYLINDER</b>				
F75	126	Passage	\$88.00	\$96
F76	176	Privacy	\$92.00	\$100.00
<b>SINGLE CYLINDER</b>				
F86	115	Store Room	\$124.00	\$132.00
F109	116	Entrance		
<b>DUMMY</b>				
	211	Single Dummy	\$44.00	\$48.00

List prices shown include cylinder.

## Rose Trim

CODE	DESCRIPTION	LOCK ADJUSTMENT
—	Round Rose	N/C
SR	Square Rose (Function 211)	\$10.00
	Square Rose (Function 115,116,126,176)	\$20.00



ROUND ROSE



SQUARE ROSE

SF SERIES  
CYLINDRICAL LOCKS

## Levers



PHILADELPHIA



BOSTON



MIAMI



MEMPHIS



ORLANDO

CYLINDER OPTIONS	ICON	LOCK ADJUSTMENT
D		N/C
SFL		

IC Core not included see page 83 for core options.



### Non-Fire Rated Adjustable Latch (Standard on Non-Keyed Functions)

CODE	DESCRIPTION	LOCK ADJUSTMENT
ADJ	Adjustable non-fire rated latch, 1" face width with 1/4" radius corner with 1-1/8" square corner filler	N/C
234	Fixed 2-3/4" backset fire rated latch, Square Corner 1-1/8" face	\$9.00
238	Fixed 2-3/8" backset fire rated latch, Square Corner 1" face	
238R	Fixed 2-3/8" backset fire rated latch, Radius Corner 1" face	

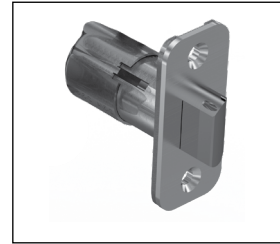

Non-Fire Rated Adjustable Latch

### UL Fire Rated Fixed Backset Option for Non-Keyed Functions\*

CODE	DESCRIPTION	LOCK ADJUSTMENT
234	Fixed 2-3/4" backset fire rated latch, Square Corner 1-1/8" face	N/C
238	Fixed 2-3/8" backset fire rated latch, Square Corner 1" face	\$9.00
238R	Fixed 2-3/8" backset fire rated latch, Radius Corner 1" face	



Fire Rated Fixed Latch

\*Standard on Keyed Functions, BHMA Certified.

### Strikes

	CODE	DESCRIPTION	LOCK ADJUSTMENT
	ASA	ASA Strike (any finish) 1-1/4" x 4-7/8"	N/C
	T	T-Strike (any finish) 1-1/8" x 2-3/4"	
	FL	Full Lip Strike (any finish) 1-5/8" x 2-1/4"	



**NOTES:**

- Specify finish for Strikes & Latchbolts if ordered separately

### Options

CODE	DESCRIPTION	LOCK ADJUSTMENT
SF	Split Finishes (Added to highest finish price)	\$8.00

### Strike Parts

	CODE	DESCRIPTION	605	613E	619	622	625	630	PART LIST PRICE
	ASA	ASA Strike (any finish) 1-1/4" x 4-7/8"	V91900-5	V91900-6	V91900-E	V91900-H	V91900-2	V91900-1	\$38.00
	T	T-Strike (any finish) 1-1/8" x 2-3/4"	V91901-5	V91901-6	V91901-E	V91901-H	V91901-2	V91901-1	\$17.00
	FL	Full Lip Strike (any finish) 1-5/8" x 2-1/4"	V919010-5	V919010-6	V919010-E	V919010-H	V919010-2	V919010-1	\$14.00

## Cylinders

PDQ KEYWAY	COMPATIBLE WITH	SOLD WITH LOCK	
AR1	Arrow / AR1	N/C	
CO59A1	Corbin / 59A1		
CO6	Corbin / 60		
CL4	Corbin / L4		
RUD	Russwin / D1		
SCE	Schlage / E		
SCC	Schlage / C		
SCC-K	Schlage / C-K		
SAL	Sargent / LA		
RA-RC	Sargent / RA-RC		
YA8	Yale / E1R		
GA	Yale / GA		
FAL	Falcon / E-R		
KW	Kwikset		
TA	PDQ / TA (Restricted. Limited to Grandmaster systems w/4 masters)		
Dummy	—		
T-Turn	—		
L	Less Cylinder		Deduct \$4.00
<b>HIGH SECURITY CYLINDERS AND CORES</b>			
SEE HIGH SECURITY CYLINDERS AND CORES SECTION, PAGE 118			

**NOTES:**

- Specify finish for cylinders ordered separately
- Kwikset cylinder available in 5 pin only
- Specify KD, KA4, or 1 bitted
- 6 pin cylinder keyed for 5 pin

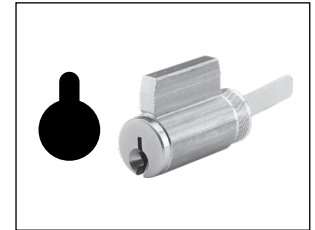

Key in Knob/Lever Cylinder



UL 437 and High Security Cylinders

## Cores and Keyways

DESCRIPTION	PDQ NO.	ADD
<b>SMALL FORMAT UNCOMBINATED</b>		
6 Pin Cores	I5206 + KEYWAY	\$40.00
7 Pin Cores	I5207 + KEYWAY	
<b>COMBINATED</b>		
6 Pin Cores	I5206-1 + KEYWAY	\$60.00
7 Pin Cores	I5207-1 + KEYWAY	
<b>BEST™ Compatible</b>		
A (DEFAULT), B, C, D, E, F, G, H, J, K, L, M, Q, WA, WB, WC, WG, WH, TB, TD, TE, & R		
<b>PDQ Exclusive</b>		
PDQ1, PDQ2		
<b>PDQ Exclusive and Restricted</b>		
PDQ3		
<b>SFIC CONSTRUCTION</b>		
Construction Core 6-pin only		\$60.00
Dummy Construction Core Plastic		\$8.00
<b>HIGH SECURITY IC CORES</b>		
SEE HIGH SECURITY CYLINDERS AND CORES SECTION, PAGE 118.		



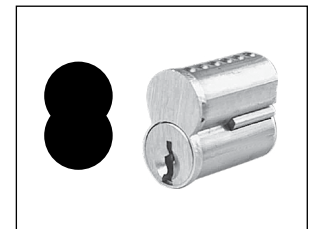

**NOTES:**

- Specify finish for IC Cores ordered separately
- Control keys must be ordered separately
- **PDQ1, PDQ2, PDQ3 (Restricted)**, Best A2 & A4 Systems Available



SFL/SFIC Core

## PDQ Functions

FUNCTION	FUNCTION NUMBER	INSIDE   OUTSIDE	DESCRIPTION	ANSI NUMBER
<b>NON KEYED</b>				
Passage	SF126		<ul style="list-style-type: none"> <li>Latchbolt operated by lever from either side at all times</li> </ul>	F75
Privacy Bedroom Bathroom	SF176		<ul style="list-style-type: none"> <li>Latchbolt operated by lever from either side or emergency release in outside lever</li> <li>Outside lever locked by push button on inside</li> <li>Outside lever unlocked by emergency release from outside, rotating inside lever, or closing door</li> </ul>	F76
<b>KEYED</b>				
Storeroom	SF115	 <p>Fixed backset, fire rated, BHMA latch included.</p>	<ul style="list-style-type: none"> <li>Latchbolt operated from outside by key, inside by lever</li> <li>Outside lever always fixed</li> <li>Inside lever always free</li> <li>Deadlocking (guarded) latchbolt</li> </ul>	F86
Entrance	SF116	 <p>Fixed backset, fire rated, BHMA latch included.</p>	<ul style="list-style-type: none"> <li>Latchbolt operated by lever from either side or key in outside lever</li> <li>Outside lever locked by push/turn button on inside</li> <li>When outside lever is locked by push button on inside – key from outside, or rotating inside lever unlocks outside lever</li> <li>When outside lever is locked by pushing and turning the button on the inside, key from outside or rotating inside lever retracts latch but does not unlock outside lever</li> <li>Deadlocking (guarded) latchbolt</li> </ul>	F109
<b>DUMMY</b>				
Single Dummy	SF211		<ul style="list-style-type: none"> <li>Pull lever one side</li> <li>No mechanical operation</li> </ul>	—



INDICATES RIGID LEVER

## Lever Cross Reference

PDQ	ARROW	CORBIN	DORMA	FALCON	HAGER	SARGENT	SCHLAGE	ACCENTRA
MIAMI — MIA		AZD	LG			B	JAZ	MO
PHILADELPHIA — PHL	BRR	NZD	LR	D	WTS	L	ELA	AU
BOSTON — BSN	SR	PZD	LC	Q	ARC	P		PB
MEM — MEMPHIS								
ORL — ORLANDO							LAT	



PHILADELPHIA — PHL



BOSTON — BSN



MIAMI — MIA



MEMPHIS — MEM



ORLANDO — ORL



**ALL LEVERS**

Information on this sheet is compiled from public documents and third parties. As a result, PDQ makes no guarantees as to their accuracy, content, quality or availability. Comparisons were made using the technical features only and are not commercial comparisons. Final suitability should be determined by a professional hardware consultant.

## Typical Applications

- Assisted Living
- Hospitality
- Military Housing
- Multi-family
- Offices
- Retail

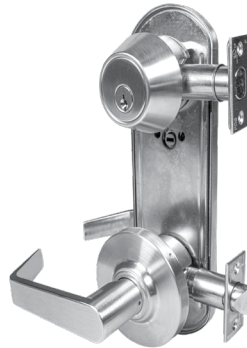



## Specifications

<b>FOR DOORS:</b>	• 1-3/8" and 1-3/4" thick.
<b>PREPARATION:</b>	• ANSI/BHMA A156.115 for 4" and 5-1/2" hole centers, field selectable.
<b>DUST BOX:</b>	• Included for Latchbolt and Deadbolt.
<b>LATCHBOLT BACKSET:</b>	• 2-3/8" or 2-3/4" (Default). Specify when ordering
<b>DEADBOLT BACKSET:</b>	• Field adjustable for 2-3/8" and 2-3/4" (Default).
<b>STRIKE:</b>	• "T"-Strike (Default) • ASA or Full-Lip optional
<b>LEVERS:</b>	• Boston, Miami, Memphis, Orlando, Philadelphia
<b>ROSE:</b>	• 2-3/8" Round Rose, 2-15/16" Square Rose
<b>INSIDE ESCUTCHEON:</b>	• 3-3/4"W x 9-3/4"H (Wrought)
<b>LATCHBOLT:</b>	• 1/2" Throw
<b>DEADBOLT:</b>	• 1" Throw • Brass Bolt containing one 1/4" case-hardened Steel Roll Pin
<b>HANDING:</b>	• Non-handed (Except for Memphis Lever)
<b>KEYS:</b>	• Two (2) per Lock
<b>KEYWAYS:</b>	• SCC Default (Schlage C Compatible). For additional keyways, see Cylinders and Keying section.
<b>INTERCHANGEABLE CORE:</b>	• 6-pin or 7-pin • Compatible with Best SFIC. • Not available in high security.
<b>CONVENTIONAL KEY IN KNOB/LEVER CYLINDER:</b>	• 6-pin Cylinder keyed to 5-pins
<b>KEYING:</b>	• Options: MK, CMK, or GMK, Zero Bitted (KO), Keyed Different (KD) or Keyed Alike (KA) • Can be keyed into existing master key systems. See Keyways Section.
<b>FINISHES:</b>	• 605 (US3), 613E, 622 (US19), 626 (US26D) * OTHER FINISHES AVAILABLE. CONTACT CUSTOMER SERVICE FOR QUOTE AND LEAD-TIME.
<b>CERTIFICATIONS, LISTINGS, COMPLIANCES:</b>	• ANSI, Grade 2 • UL listed for 3 hrs, for single doors up to 4'0" x 8'0" • Complies with ADA (Americans with Disabilities Act) and ICC/ANSI 117.1 for Accessible and Usable Buildings • TAA compliant. Country of origin: KR
<b>WARRANTY:</b>	• Two (2) year Limited Warranty

### How to Order

QUANTITY	TYPE	FUNCTION	LEVER	ROSE	FINISH	BACKSET	HANDING	STRIKE	CYLINDER	KEYWAY	OPTION
6	CL	116	PHL	—	626	234	—	FL	D	SCC	—
			MIA — Miami	BLANK — Round Rose (default)	605	238 — 2-3/8"	LH — Left Hand	ASA — ASA	D Default	PAGE 89	DB — Dust Box
			PHL — Philadelphia	(default) All Levers	613E	234 — 2-3/4"	RH — Right Hand	FL — Full Lip	L Less Cylinder		
			BSN — Boston	SR — Square Rose (Orlando Lever Only)	622			T — "T" Strike (default)	SF6 Lock is SFIC prepped w/ 6 pin core		
			MEM — Memphis		626				SF7 Lock is SFIC prepped w/ 7 pin core		
			ORL — Orlando						SFL Lock is SFIC prepped but less core		
									SFC Lock is SFIC prepped w/ construction core		
									SFP Lock is SFIC prepped w/ plastic construction core		
						PAGE 90		PAGE 88	PAGE 89		PAGE 90

ANSI NO.	FUNCTION	DESCRIPTION	626	605/613E 622
<b>NON-KEYED</b>				
	176	Passage Lever with Deadbolt Indicator	\$362.00	\$384.00
<b>SINGLE CYLINDER</b>				
F95	126	Entrance, Passage Lever	\$444.00	\$466.00
<b>DOUBLE CYLINDER</b>				
F98	115	Storeroom, Privacy Lever	\$463.00	\$485.00
F97	116	Entrance, Privacy Lever		
<b>List prices shown include conventional key in knob/lever cylinder.</b>				

CYLINDER OPTIONS	ICON	LOCK ADJUSTMENT
D		N/C
SFL		

IC Core not included see page 89 for core options

#### NOTES:

- Prices do not include IC Cores
- Locks will be furnished with 2-3/4" Backset, T-Strike & SCC Keyway unless otherwise stated
- 2-3/4" Latchbolt will be furnished with 2-1/4" x 1-1/8" faceplate unless otherwise stated
- 2-3/8" Latchbolt will be furnished with 2-1/4" x 1" faceplate unless otherwise stated

### Trim

CODE	DESCRIPTION	LOCK ADJUSTMENT
—	Round Rose	N/C
SR	Square Rose	\$20.00



# CL SERIES

**LIST PRICE**  
Effective July 3, 2023

## Lever Designs

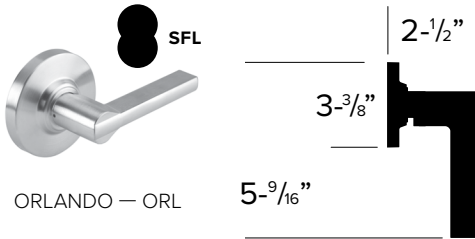
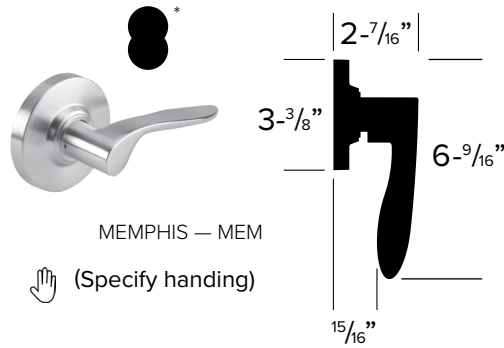
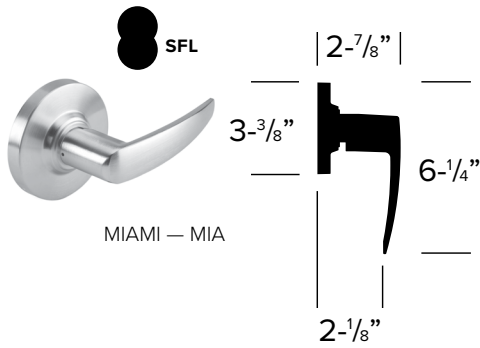
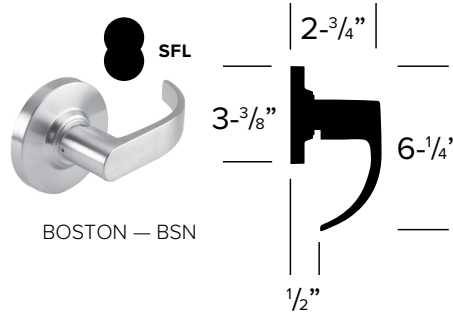
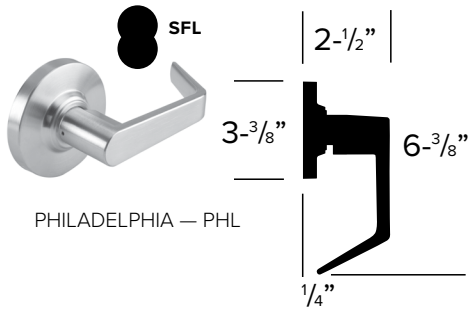

## Trim Designs

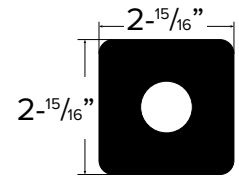

### ALL LEVERS

\* Small Format with MEM lever is only available in non-keyed, and single cylinder configurations.

## Dimensions

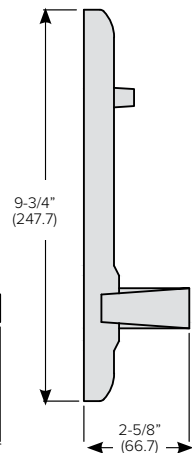
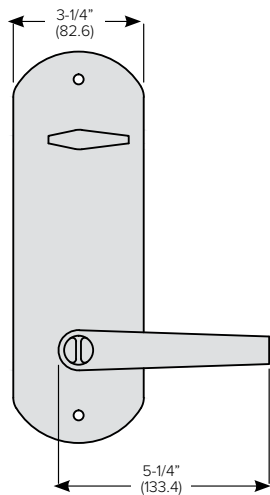

2-3/4" (69.9) Standard,  
2-3/8" (60.3) Optional

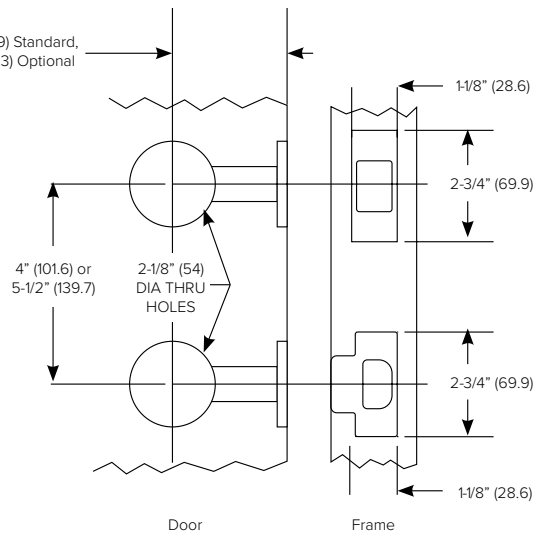

Note: Dimensions in parenthesis in millimeters

Note: Fits ANSI/BHMA 156.115 door preparation for Interconnected Locks

### Latchbolts

CODE	BACKSET	FACEPLATE	CORNERS	LOCK ADJUSTMENT
238	2-3/8"	2-1/4" X 1	SQUARE (DEFAULT)	N/C
238F		2-1/4" X 1-1/8"	SQUARE	
238R		2-1/4" X 1	1/4" RADIUS	
238	2-3/4"	2-1/4" X 1	SQUARE (DEFAULT)	
238F		2-1/4" X 1-1/8"	SQUARE	
238R		2-1/4" X 1	1/4" RADIUS	
234F	2-3/4"	2-1/4" X 1	SQUARE	
234		2-1/4" X 1-1/8"	SQUARE (DEFAULT)	
234F		2-1/4" X 1	SQUARE	
234		2-1/4" X 1-1/8"	SQUARE (DEFAULT)	
234R		2-1/4" X 1-1/8"	1/4" RADIUS	

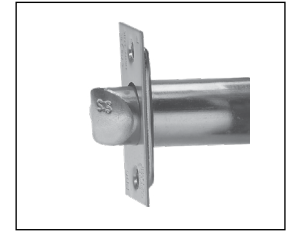

Dead Latch



Springlatch

### Strikes

	CODE	DESCRIPTION	LOCK ADJUSTMENT
	ASA	ASA Strike (any finish) 1-1/4" x 4-7/8"	N/C
	T	T-Strike (any finish) 1-1/8" x 2-3/4"	
	FL	Full Lip Strike (any finish) 1-5/8" x 2-1/4"	

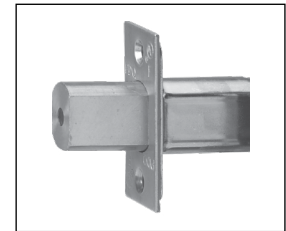

Deadbolt

Note 1 - Dust Boxes for Deadbolt and Latchbolt included with the lock.

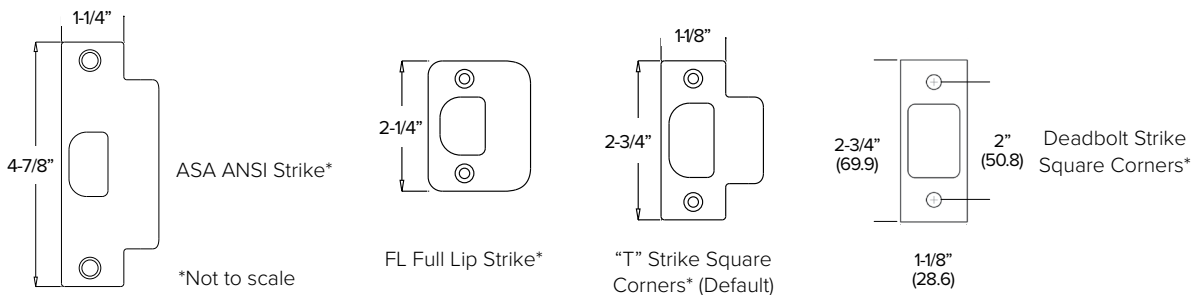

### Keyways and Cylinders

PDQ KEYWAY	COMPATIBLE WITH	SOLD WITH LOCK	
AR1	Arrow / AR1	N/C	
CO59A1	Corbin / 59A1		
CO6	Corbin / 60		
CL4	Corbin / L4		
RUD	Russwin / D1		
SCE	Schlage / E		
SCC	Schlage / C		
SCC-K	Schlage / C-K		
SAL	Sargent / LA		
RA-RC	Sargent / RA-RC		
YA8	Yale / EIR		
GA	Yale / GA		
FAL	Falcon / E-R		
KW	Kwikset		
TA	PDQ / TA (Restricted. Limited to Grandmaster systems w/4 masters)		
Dummy	—		
T-Turn	—		
L	Less Cylinder		Deduct \$4.00

**NOTES:**

- Specify finish for cylinders ordered separately
- Kwikset cylinder available in 5 pin only
- Specify KD, KA4, or 1 bitted
- 6 pin cylinder keyed for 5 pin

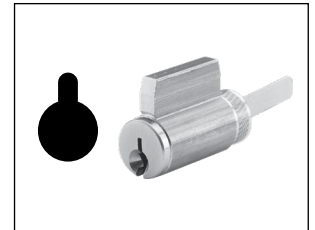

Key in Knob/Lever Cylinder

### Cores and Keyways

DESCRIPTION	PDQ NO.	ADD
<b>UNCOMBINED</b>		
6 Pin Cores	I5206 + KEYWAY	\$40.00
7 Pin Cores	I5207 + KEYWAY	
<b>COMBINED</b>		
6 Pin Cores	I5206-1 + KEYWAY	\$60.00
7 Pin Cores	I5207-1 + KEYWAY	
<b>BEST Compatible</b>		
A (DEFAULT), B, C, D, E, F, G, H, J, K, L, M, Q,		
WA, WB, WC, WG, WH, TB, TD, TE, & R		
<b>PDQ Exclusive</b>		
PDQ1, PDQ2		
<b>PDQ Exclusive and Restricted</b>		
PDQ3		
<b>SFIC CONSTRUCTION</b>		
Construction Core 6-pin only		\$60.00
Dummy Construction Core Plastic		\$8.00

**NOTES:**

- Specify finish for IC Cores ordered separately
- Control keys must be ordered separately
- **PDQ1, PDQ2, PDQ3 (Restricted)**, Best A2 & A4 Systems Available

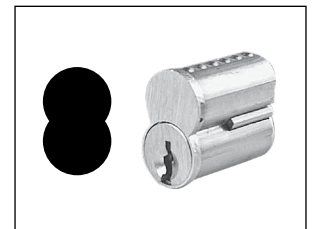

SFL/SFIC Core

### Options

CODE	DESCRIPTION	LOCK ADJUSTMENT
DB	Dust Box	\$8.00

### Backset

BACKSET	TYPE	FACEPLATE	CORNERS	PDQ NUMBER	PART LIST PRICE
2-3/8"	SPRINGLATCH	2-1/4" X 1	SQUARE (DEFAULT)	V21900-722	\$68.00
		2-1/4" X 1-1/8"	SQUARE	V21900-724	
		2-1/4" X 1	1/4" RADIUS	V21900-722R	
	DEADLATCH	2-1/4" X 1	SQUARE (DEFAULT)	V21900-721	
		2-1/4" X 1-1/8"	SQUARE	V21900-723	
		2-1/4" X 1	1/4" RADIUS	V21900-721R	
		ADJUSTABLE	2-1/4" X 1	SQUARE (DEFAULT)	
2-1/4" X 1	1/4" RADIUS		I04507R		
2-3/4"	SPRINGLATCH	2-1/4" X 1	SQUARE	V21900-714	
		2-1/4" X 1-1/8"	SQUARE (DEFAULT)	V21900-712	
	DEADLATCH	2-1/4" X 1	SQUARE	V21900-713	
		2-1/4" X 1-1/8"	SQUARE (DEFAULT)	V21900-711	

### Deadbolts

BACKSET	TYPE	FACEPLATE	CORNERS	PDQ NUMBER	LIST PRICE
2-3/8" AND 2-3/4"	ADJUSTABLE	2-1/4" X 1	SQUARE (DEFAULT)	I04507	\$52.00
		2-1/4" X 1	1/4" RADIUS	I04507R	
2-3/4" (DEFAULT)	FIXED	2-1/4" X 1-1/8"	SQUARE	I04510	

### Strikes

	CODE	DESCRIPTION	605	613E	622	630	LIST PRICE
	ASA	ASA Strike (any finish) 1-1/4" x 4-7/8"	V91900-5	V91900-6	V91900-H	V91900-7	\$38.00
	T	T-Strike (any finish) 1-1/8" x 2-3/4"	V91901-5	V91901-6	V91901-H	V91901-7	\$17.00
	FL	Full Lip Strike (any finish) 1-5/8" x 2-1/4"	V919010-5	V919010-6	V919010-H	V919010-7	\$14.00
	W	Deadbolt Strike	I4072-5	I4072-6	I4072-H	I4072-7	

## PDQ Functions

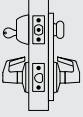
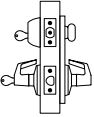
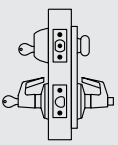
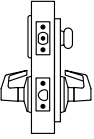
FUNCTION	FUNCTION NUMBER	OUTSIDE   INSIDE	DESCRIPTION	ANSI NUMBER
Entry Single Cylinder Passage Lever	126		<ul style="list-style-type: none"> <li>• Outside and Inside lever always free</li> <li>• Deadbolt projected or retracted by key outside or turnpiece inside</li> <li>• When deadbolt is projected, turning inside knob/lever retracts deadbolt and latchbolt simultaneously</li> </ul>	F95
Storeroom Double Cylinder (See note) Passage Lever	115		<ul style="list-style-type: none"> <li>• Deadlocking latch bolt is operated by key outside or inside lever</li> <li>• Key outside projects or retracts dead bolt.</li> <li>• Operating inside lever or keys outside retracts dead bolt and deadlocking latch.</li> </ul>	F98
Entry Double Cylinder (See note) Privacy Lever	116		<ul style="list-style-type: none"> <li>• Outside lever locked by turn button in inside knob/lever</li> <li>• Inside lever always free</li> <li>• Unlocking of outside lever requires use of key or manual return of inside turn button</li> <li>• Deadbolt is activated by key in outside deadlock or turnpiece inside</li> <li>• Turning inside lever retracts deadbolt and latchbolt simultaneously</li> </ul>	F97
Privacy with Dead Bolt Indicator No Cylinder Passage Lever	176		<ul style="list-style-type: none"> <li>• Outside and Inside lever always free</li> <li>• Indicator outside</li> <li>• Thumbturn inside extends/retracts deadbolt</li> <li>• Emergency key outside retracts deadbolt</li> <li>• When deadbolt is projected, turning inside lever retracts deadbolt and latchbolt simultaneously</li> </ul>	—

## Cross Reference

ANSI NUMBER / FUNCTION	PDQ	CAL-ROYAL	DORMA	FALCON	HAGER	SCHLAGE	STANLEY	ACCENTRA
95 / ENTRY, SINGLE CYLINDER	CL 126	HIL00, JHIL00	J310	—	3710	CS/RS 210 SERIES	QC1230 SERIES	4851LN
97 / ENTRY, DOUBLE CYLINDER	CL 116	HIL30, JHIL30	J353	H101DG	3753	CS/RS 250 SERIES	QC1250 SERIES	4871LN
98 / STOREROOM, DOUBLE CYLINDER	CL 115	—	—	—	—	CS/RS 280 SERIES	QC1285 SERIES	—
PRIVACY W/INDICATOR, NO CYLINDER	CL 176	—	—	—	—	—	QC1285 SERIES	—

Information on this sheet is compiled from public documents and third parties. As a result, PDQ makes no guarantees as to their accuracy, content, quality or availability. Comparisons were made using the technical features only and are not commercial comparisons. Final suitability should be determined by a professional hardware consultant.

## Typical Applications

- Apartments
- Back-of-House Hotel/Motel
- Heavy-Duty Residential
- Houses of Worship
- Medium Traffic Commercial Applications
- Offices
- Retail Backroom
- Retrofit/Repair/Replacement
- Warehouses

## Features

- UL listed for 3-hour fire door
- ANSI/BHMA A156.2 Grade 2
- 9 standard functions
- Various strike and latch options to accommodate any opening
- Available in keyways of most major manufacturers
- Tactile abrasive coating option
- Antimicrobial coating option
- One (1) year limited warranty



## Specifications





<b>FOR DOORS:</b>	• 1-3/8" to 1-3/4" thick
<b>BACKSET:</b>	• 2-3/4" standard • 2-3/8", 5" optional
<b>FRONT:</b>	• 2-1/4" x 1-1/8" or 2-1/4" x 1" • Stainless Steel or Wrought Brass
<b>STRIKE:</b>	• 4-7/8" x 1-1/4" (ASA). "T" or "FL" Strike optional. Stainless steel or wrought bronze.
<b>ROSE:</b>	• 3" DIA Wrought
<b>LATCHBOLT:</b>	• 1/2" throw. Solid brass. Adjustable for beveled doors.
<b>HAND:</b>	• Non-handed
<b>KEYS:</b>	• Two change keys per lock.
<b>KEYWAYS:</b>	• Available in keyways of most major manufacturers.
<b>CYLINDER:</b>	• Brass 6-pin cylinder keyed to 5 pins. • Standard High Security and UL437 Cylinders Available
<b>TRIM:</b>	• Stainless Steel or Wrought Brass Knobs and Roses
<b>KEYING:</b>	• Can be MK, CMK, GMK, or CK. Available Zero Bitted (KO), Keyed Different (KD), Keyed Alike (KA). Can be keyed into existing masterkey systems of other manufacturers.
<b>FINISHES:</b>	• 630 (US32D) • Optional Antimicrobial Coating available
<b>WARRANTY:</b>	• One (1) Year Limited Warranty
<b>CERTIFICATIONS, LISTINGS, COMPLIANCES:</b>	• Certified to ANSI/BHMA A156.2, Grade 2 • UL/CUL 10C listed for 3 hrs, for single doors up to 4'0" x 8'0" • TAA compliant. Country of origin: KR

### How to Order

QUANTITY	SERIES	FUNCTION	KNOB	FINISH	BACKSET	STRIKE	CYLINDER	KEYWAY	KEYING
20	SV	116	CQ	630	234	ASA	D	SCC	KD
				605 613E	234 — 2-3/4" 238 — 2-3/8" 334 — 3-3/4" 5 — 5"	ASA — ANSI/ ASA (default) FL — Full Lip T — "T" Strike See page 94	D Default L Less Cylinder SF6 Lock is SFIC prepped w/ 6 pin core SF7 Lock is SFIC prepped w/ 7 pin core SFL Lock is SFIC prepped but less core SFC Lock is SFIC prepped w/ construction core SFP Lock is SFIC prepped w/ plastic construction core	PAGE 95	
						PAGE 94	PAGE 95		

NOTE: Case quantity is 20 / Case weight is 43 lbs. Keyed Functions / Case weight is 40 lbs. Non-Keyed Functions / For split finishes, designate O/S trim first, then I/S

ANSI NO.	FUNCTION	DESCRIPTION	630	605/613E
<b>NON-CYLINDER</b>				
	125	Communicating	\$100.00	\$109.00
F75	126	Passage		
F76	176	Privacy	\$104.00	\$113.00
<b>SINGLE CYLINDER</b>				
F86	115	Store Room	\$122.00	\$131.00
F109	116	Entrance		
F84	148	Classroom		
<b>DOUBLE CYLINDER</b>				
F91	137	Store Door	\$180.00	\$189.00
<b>DUMMY</b>				
	205	Double Dummy	\$90.00	\$99.00
	211	Single Dummy	\$54.00	\$63.00
List prices shown include conventional key in knob/lever cylinder. For I-C, list prices do not include core.				

CYLINDER OPTIONS	ICON	LOCK ADJUSTMENT
D		N/C
SFL		

**NOTES:**

- Locks will be furnished with 2-3/4" Latchbolt, ASA Strike & SCC Key way unless otherwise stated
- 2-3/4" Latchbolt will be furnished with 2-1/4" x 1-1/8" faceplate unless otherwise stated
- 2-3/8" Latchbolt will be furnished with 2-1/4" x 1" faceplate unless otherwise stated

### Trim



BALL KNOB - CQ

# SV SERIES

## LIST PRICE

Effective July 3, 2023

CODE	DESCRIPTION	LOCK ADJUSTMENT
<b>2-3/4" BACKSET</b>		
234	2-1/4" x 1-1/8"	N/C
234F	2-1/4" x 1"	
234FR	2-1/4" x 1" x 1/4" Radius	
<b>2-3/8" BACKSET</b>		
238F	2-1/4" x 1-1/8"	N/C
238	2-1/4" x 1"	
238R	2-1/4" x 1" x 1/4" Radius	
<b>3-3/4" BACKSET</b>		
334F	2-1/4" x 1-1/8"	\$18.00
334	2-1/4" x 1"	
334R	2-1/4" x 1" x 1/4" Radius	
<b>5" BACKSET</b>		
5	2-1/4" x 1-1/8"	\$24.00
5F	2-1/4" x 1"	
5FR	2-1/4" x 1" x 1/4" Radius	



Latchbolt

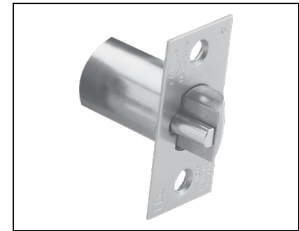

Deadlatch

## Strikes

	CODE	DESCRIPTION	LOCK ADJUSTMENT
	ASA	ASA Strike (any finish) 1-1/4" x 4-7/8"	N/C
	T	T-Strike (any finish) 1-1/8" x 2-3/4"	
	FL	Full Lip Strike (any finish) 1-5/8" x 2-1/4"	

**NOTES:**

- Specify finish for Strikes & Latchbolts if ordered separately



## Keyways and Cylinders

PDQ KEYWAY	COMPATIBLE WITH	SOLD WITH LOCK	
AR1	Arrow / AR1	N/C	
CO59A1	Corbin / 59A1		
CO6	Corbin / 60		
CL4	Corbin / L4		
RUD	Russwin / D1		
SCE	Schlage / E		
SCC	Schlage / C		
SCC-K	Schlage / C-K		
SAL	Sargent / LA		
RA-RC	Sargent / RA-RC		
YA8	Yale / E1R		
GA	Yale / GA		
FAL	Falcon / E-R		
KW	Kwikset		
TA	PDQ / TA (Restricted. Limited to Grandmaster systems w/4 masters)		
Dummy	—		
T-Turn	—		
L	Less Cylinder		Deduct \$4.00
<b>HIGH SECURITY CYLINDERS AND CORES</b>			
SEE HIGH SECURITY CYLINDERS AND CORES SECTION, PAGE			

**NOTES:**

- Specify finish for cylinders ordered separately
- Kwikset cylinder available in 5 pin only
- Specify KD, KA4, or 1 bitted
- 6 pin cylinder keyed for 5 pin

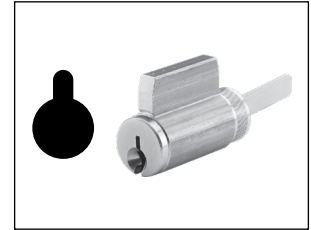

Key in Knob/Lever Cylinder



UL 437 and High Security Cylinders

## Cores and Keyways

DESCRIPTION	PDQ NO.	ADD
<b>SMALL FORMAT UNCOMBINATED</b>		
6 Pin Cores	I5206 + KEYWAY	\$40.00
7 Pin Cores	I5207 + KEYWAY	
<b>COMBINATED</b>		
6 Pin Cores	I5206-1 + KEYWAY	\$60.00
7 Pin Cores	I5207-1 + KEYWAY	
<b>BEST<sup>™</sup> Compatible</b>		
A (DEFAULT), B, C, D, E, F, G, H, J, K, L, M, Q,		
WA, WB, WC, WG, WH, TB, TD, TE, & R		
<b>PDQ Exclusive</b>		
PDQ1, PDQ2		
<b>PDQ Exclusive and Restricted</b>		
PDQ3		
<b>SFIC CONSTRUCTION</b>		
Construction Core 6-pin only		\$60.00
Dummy Construction Core Plastic		\$8.00
<b>HIGH SECURITY IC CORES</b>		
SEE HIGH SECURITY CYLINDERS AND CORES SECTION, PAGE 118. — LFIC REQUIRES LARGE FORMAT LEVER		

**NOTES:**

- Specify finish for IC Cores ordered separately
- Control keys must be ordered separately
- **PDQ1, PDQ2, PDQ3 (Restricted)**, Best A2 & A4 Systems Available

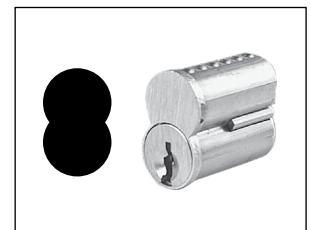

SFL/SFIC Core

# SV SERIES PARTS

**LIST PRICE**

Effective July 3, 2023

## Backset

CODE	TYPE	FACEPLATE	CORNERS	PDQ NUMBER	LIST PRICE	
<b>2-3/4" BACKSET</b>						
234F	SPRINGLATCH	2-1/4" X 1	SQUARE	V21900-714	\$68.00	
234		2-1/4" X 1-1/8"	SQUARE (DEFAULT)	V21900-712		
234F	DEADLATCH	2-1/4" X 1	SQUARE	V21900-713		
234		2-1/4" X 1-1/8"	SQUARE (DEFAULT)	V21900-711		
<b>2-3/8" BACKSET</b>						
238	SPRINGLATCH	2-1/4" X 1	SQUARE (DEFAULT)	V21900-722		
238F		2-1/4" X 1-1/8"	SQUARE	V21900-724		
238R		2-1/4" X 1	1/4" RADIUS	V21900-722R		
238	DEADLATCH	2-1/4" X 1	SQUARE (DEFAULT)	V21900-721		
238F		2-1/4" X 1-1/8"	SQUARE	V21900-723		
238R		2-1/4" X 1	1/4" RADIUS	V21900-721R		
<b>3-3/4" BACKSET EXTENSION</b>						
Extension for 2-3/8" latch (sold separately) to make 3-3/4" Backset.				V21903	\$55.00	
<b>5" BACKSET EXTENSION</b>						
Extension for 2-3/4" latch (sold separately) to make 5" Backset.				V21902		

## Strikes

	CODE	DESCRIPTION	605	613E	630	LIST PRICE
	ASA	ASA Strike (any finish) 1-1/4" x 4-7/8"	V91900-5	V91900-6	V91900-1	\$38.00
	T	T-Strike (any finish) 1-1/8" x 2-3/4"	V91901-5	V91901-6	V91901-1	\$17.00
	FL	Full Lip Strike (any finish) 1-5/8" x 2-1/4"	V919010-5	V919010-6	V919010-1	\$14.00

### PDQ Functions

FUNCTION	FUNCTION NUMBER	INSIDE   OUTSIDE	DESCRIPTION	ANSI NUMBER
<b>NON KEYED</b>				
Closet/ Communicating	SV125		<ul style="list-style-type: none"> <li>• Blank plate outside</li> <li>• Inner knob always free</li> <li>• Deadlocking (guarded) latchbolt</li> </ul>	—
Passage	SV126		<ul style="list-style-type: none"> <li>• Latchbolt operated by both knobs</li> </ul>	F75
Privacy Bedroom Bathroom	SV176		<ul style="list-style-type: none"> <li>• Latchbolt operated by both knobs</li> <li>• Push button in inside knob locks outside knob</li> <li>• Inside knob or closing door releases button</li> <li>• Emergency opening from outside</li> </ul>	F76
<b>KEYED</b>				
Storeroom	SV115		<ul style="list-style-type: none"> <li>• Latchbolt operated from outside by key, inside by knob</li> <li>• Outside knob is rigid at all times</li> <li>• Inside knob always free for immediate exit</li> </ul>	F86
Entrance	SV116		<ul style="list-style-type: none"> <li>• Latchbolt operated by both knobs</li> <li>• Outside knob locked or unlocked by turn/push button</li> <li>• Inside knob always free</li> <li>• Pushing and turning button locks outside knob requiring use of key until button is manually unlocked</li> <li>• Pushing button only locks outside knob until unlocked with key or inside knob is turned</li> </ul>	F109
General Entrance	SV137		<ul style="list-style-type: none"> <li>• Latchbolt operated by both knobs</li> <li>• Key on either side locks or unlocks</li> </ul>	—
Classroom Storage	SV148		<ul style="list-style-type: none"> <li>• Latchbolt operated from outside by knob except when locked from outside by key</li> <li>• Latchbolt operated from inside by knob at all times</li> </ul>	F84
<b>DUMMY</b>				
Single Dummy	SV211		<ul style="list-style-type: none"> <li>• Single pull knob</li> <li>• Single side surface</li> <li>• No mechanical operation</li> </ul>	—
Double Dummy	SV205		<ul style="list-style-type: none"> <li>• Double pull knob</li> <li>• Both sides</li> <li>• No mechanical operation</li> <li>• 2-1/8" bored hole</li> </ul>	—

INDICATES RIGID KNOB

## Secure. Durable. Versatile.

Deadbolts are often paired with a cylindrical lock in commercial office spaces, residential applications and other spaces where there is a greater need for security—and, more specifically, a deadbolt that is more resistant to brute force attack. PDQ deadbolts provide security for a wide range of applications while allowing end users to meet their specific security needs.

---

### KM

Heavy Duty Rim Cylinder  
Mechanical



#### Applications

Heavy duty performance. Ideal for commercial, institutional, government, military, hospitality, hospital, multi-family, offices, and retail applications. Typical installations include storerooms, auxiliary entrance locks, communication doors in hotels, and aluminum storefronts.

---

### KT

Extra Heavy Duty  
Mortise Cylinder



#### Applications

Heavy duty performance. Ideal for commercial, institutional, government, military, hospitality, hospital, multi-family, offices, and retail applications.

---

### KV

Commercial Duty  
Rim Cylinder



#### Applications

Standard duty performance, ideal for light commercial and residential applications.

---

### MJ

Extra Heavy Duty  
Mortise Cylinder



#### Applications

Small body deadbolt provides an extra measure of protection at a competitive price. Uses include common areas, auxiliary doors, closets, storerooms, and equipment rooms in commercial, institutional and military applications.

## Typical Applications

- Commercial
- Government
- Hospitality
- Institutional
- Military
- Multi-family
- Offices
- Retail



Deadbolt is Grade Comparable with GP and SD Series Grade 2 Cylindrical Locks

## Specifications



ADA COMPLIANT

<b>FOR DOORS:</b>	• 1-3/8" to 1-3/4" thick for Conventional Cylinder, 1-1/2" to 2" for SFIC
<b>DOOR PREP:</b>	• 2-1/8" DIA
<b>BACKSET:</b>	• 2-3/4" - 2-3/8" adjustable (Default) • 2-3/4" (Option)
<b>FRONT:</b>	• 2-1/4" x 1-1/8" (Default) • 2-1/4" x 1" faceplate available • Stainless Steel or Wrought Brass
<b>STRIKE:</b>	• 2-3/4" x 1-1/8" • Stainless Steel or Wrought Brass • Dust Box Included
<b>DEADBOLT:</b>	• 1" Throw • Brass Bolt containing one 1/4" case-hardened Steel Roll Pin
<b>THUMBTURN:</b>	• ADA Compliant
<b>HAND:</b>	• Non-handed
<b>TRIM:</b>	• Stainless Steel or Wrought Brass Scalp • Reinforced Diecast Rose
<b>KEYS:</b>	• Two (2) per Lock
<b>KEYWAYS:</b>	• SCC standard (Schlage C Compatible) • Also available in keyways of other manufacturers
<b>INTERCHANGEABLE CORE:</b>	• 6 or 7-pin • Compatible with Best, Falcon and Arrow
<b>CYLINDER:</b>	• 6-pin Brass Insert Cylinder keyed to 5-pins • Standard High Security and UL437 Cylinders Available
<b>KEYING:</b>	• Options: MK, CMK or GMK • Zero Bitted (KO), Keyed Different (KD) or Keyed Alike (KA) • Can be keyed into existing master key systems
<b>FINISHES:</b>	• 605 (US3), 606 (US4), 613E, 622 (US19), 626 (US26D), 630 (US32D)
<b>CERTIFICATIONS, LISTINGS, COMPLIANCES:</b>	• UL 10C listed, 3-hour fire rated as auxiliary locks for A label single doors • UL 10B listed for neutral pressure doors • Complies with ADA (Americans with Disabilities Act) and ICC/ANSI 117.1 for Accessible and Usable Buildings • TAA compliant. Country of origin: KR
<b>WARRANTY:</b>	• One (1) year Limited Warranty

## PDQ Functions

KM SERIES  
DEADBOLT LOCKS

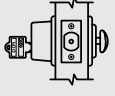
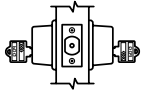
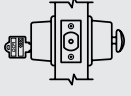
FUNCTION	FUNCTION NUMBER	OUTSIDE   INSIDE	DESCRIPTION	ANSI NUMBER
Single Cylinder	116		<ul style="list-style-type: none"> <li>Lock or unlock by key from outside, by thumb turn from inside</li> </ul>	E1151
Double Cylinder	137		<ul style="list-style-type: none"> <li>Lock or unlock by key from both sides</li> </ul>	E1141
Classroom	148		<ul style="list-style-type: none"> <li>Lock or unlock by key from outside</li> <li>Turnpiece inside retracts deadbolt, but will not project it</li> </ul>	E1171



## How to Order

QUANTITY	SERIES	FUNCTION	FINISH	BACKSET	CYLINDER	KEYWAY	KEYING
20	KM	116	630	ADJ	D	SCC	KD
NOTE: Case quantity is 20 / Case weight varies			605 606 613E 622 626 630	234 — 2-3/4" 238 — 2-3/8" ADJ — Adjustable 2-3/4"—2-3/8"(Default)	D Default L Less Cylinder SF6 Lock is SFIC prepped w/ 6 pin core SF7 Lock is SFIC prepped w/ 7 pin core SFL Lock is SFIC prepped but less core SFC Lock is SFIC prepped w/ construction core SFP Lock is SFIC prepped w/ plastic construction core	PAGE 102	
				PAGE 101	PAGE 102		

## Deadbolts

ANSI NO.	FUNCTION	DESCRIPTION	626/630	605/606/613E 622
<b>SINGLE CYLINDER</b>				
E1151	116	Entrance	\$105.00	\$117.00
E1171	148	Classroom		
<b>DOUBLE CYLINDER</b>				
E1141	137	Store Door	\$130.00	\$142.00

List prices shown include conventional RIM cylinder. For I-C, list prices do not include core.

CYLINDER OPTIONS	ICON	LOCK ADJUSTMENT
D		N/C
SFL		

**NOTES:**

- Prices do not include IC Core

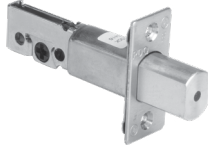

## Backset

CODE	BACKSET DESCRIPTION	LOCK ADJUSTMENT
<b>2-3/8" Backset</b>		
238	2-1/4" x 1"	N/C
238R	2-1/4" x 1" x 1/4" Radius	\$5.00
<b>2-3/4" Backset</b>		
234	2-1/4" x 1-1/8" (Standard)	N/C
234R	2-1/4" x 1-1/8" x 1/4" Radius	\$5.00
<b>2-3/4" - 2-3/8" ADJUSTABLE</b>		
ADJ	2-1/4" x 1-1/8" (Standard)	N/C
ADJR	2-1/4" x 1-1/8" x 1/4" Radius	\$5.00

### Keyways and Cylinders

KM SERIES  
DEADBOLT LOCKS

PDQ KEYWAY	COMPATIBLE WITH	SOLD WITH LOCK	
ARA	Arrow / AR1	N/C	
CO59A1	Corbin / 59A1		
CO6	Corbin / 60		
CL4	Corbin / L4		
RUD	Russwin / D1		
SCE	Schlage / E		
SCC	Schlage / C		
SCC-K	Schlage / C-K		
SAL	Sargent / LA		
RA-RC	Sargent / RA-RC		
YAB	Yale / E1R		
GA	Yale / GA		
FAL	Falcon / E-R		
TA	PDQ / TA (Restricted. Limited to Grandmaster systems w/4 masters)		\$3.00
L	Less Cylinder		Deduct \$8/Cylinder

**NOTES:**

- Specify finish for Rim Cylinders ordered separately



Rim Cylinder



UL 437 and High Security Cylinders

### Cores and Keyways

DESCRIPTION	PDQ NO.	ADD
<b>UNCOMBINED</b>		
6 Pin Cores	I5206 + KEYWAY	\$40.00
7 Pin Cores	I5207 + KEYWAY	
<b>COMBINED</b>		
6 Pin Cores	I5206-1 + KEYWAY	\$60.00
7 Pin Cores	I5207-1 + KEYWAY	
<b>BEST<sup>™</sup> Compatible</b>		
A (DEFAULT), B, C, D, E, F, G, H, J, K, L, M, Q,		
WA, WB, WC, WG, WH, TB, TD, TE, & R		
<b>PDQ Exclusive</b>		
PDQ1, PDQ2		
<b>PDQ Exclusive and Restricted</b>		
PDQ3		
<b>SFIC CONSTRUCTION</b>		
Construction Core 6-pin only		\$60.00
Dummy Construction Core Plastic Construction cores are invoiced at shipment and credited upon return.		\$8.00
<b>HIGH SECURITY IC CORES</b>		
SEE HIGH SECURITY CYLINDERS AND CORES SECTION, PAGE 118. — NOT AVAILABLE WITH LFIC		

**NOTES:**

- Combined cores include master keying in the list price
- Specify finish for IC Cores ordered separately
- Control keys must be ordered separately
- **PDQ1, PDQ2, PDQ3 (Restricted)**, Best A2 & A4 Systems Available

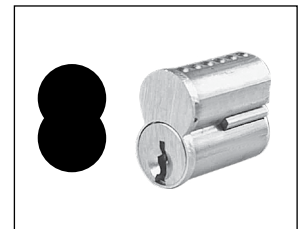

SFL/SFIC Core



# KM SERIES PARTS

**LIST PRICE**  
Effective July 3, 2023

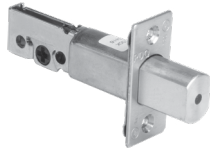

## Backset

BACKSET DESCRIPTION	605	613E	622	630	LIST PRICE	
<b>2-3/8" Backset</b>						
2-1/4" x 1-1/8" (Default)	I04509-5	I04509-6	I04509-H	I04509-1	\$50.00	
2-1/4" x 1-1/8" x 1/4" Radius	I04509-5R	I04509-6R	I04509-H	I04509-1R		
<b>2-3/4" Backset</b>						
2-1/4" x 1-1/8" (Default)	I04510-5	I04510-6	I04510-H	I04510-1		
2-1/4" x 1-1/8" x 1/4" Radius	I04510-5R	I04510-6R	I04510-H	I04510-1R		
<b>2-3/4" - 2-3/8" ADJUSTABLE</b>						
2-1/4" x 1-1/8" (Default)	I04507-5	I04507-6	I04507-H	I04507-1	\$5.00	
2-1/4" x 1-1/8" x 1/4" Radius	I04507-5R	I04507-6R	I04507-H	I04507-1R		
1-1/8" Latch Front Filler Plate (Minimum of 100 pieces)	I099-100					

**KM SERIES**  
DEADBOLT LOCKS

## Strikes

DESCRIPTION	605	613E	622	630	LIST PRICE
Deadbolt Strike 2-3/4" x 1-1/8"	I4702-5	I4702-6	I4702-H	I4702-1	\$25.00
Dust Box	I4701				\$8.00

## Typical Applications

- Commercial
- Government
- Hospitality
- Institutional
- Military
- Multi-family
- Offices
- Retail



Deadbolt is Grade Comparable with XGT and GT Series Grade 1 Cylindrical Locks

## Specifications



<b>FOR DOORS:</b>	• 1-3/4" thick standard, contact factory for other thicknesses
<b>DOOR PREP:</b>	• 2-1/8" DIA
<b>BACKSET:</b>	• 2-3/4" (Default) • 2-3/8" available
<b>FRONT:</b>	• 2-1/4" x 1-1/8" or 2-1/4" x 1" • Stainless Steel or Wrought Brass
<b>STRIKE:</b>	• 2-3/4" x 1-1/8" • Stainless Steel or Wrought Brass • Dust Box Included
<b>DEADBOLT:</b>	• 1" Throw • Brass Bolt containing two concealed 1/4" case-hardened Steel Roll Pins
<b>HAND:</b>	• Non-handed
<b>TRIM:</b>	• Wrought Brass Scalp • Reinforced Diecast Rose
<b>KEYS:</b>	• Two (2) per Lock
<b>KEYWAYS:</b>	• SCC standard (Schlage C Compatible) • Also available in keyways of other manufacturers
<b>CYLINDER:</b>	• 6-pin Brass Mortise Cylinder keyed to 5-pins, SFIC
<b>KEYING:</b>	• Options: MK, CMK or GMK • Zero Bitted (KO), Keyed Different (KD) or Keyed Alike (KA) • Can be keyed into existing master key systems
<b>FINISHES:</b>	• 605 (US3), 606 (US4), 612 (US10), 613E, 625 (US26), 626 (US26D)
<b>WARRANTY:</b>	• One (1) year Limited Warranty
<b>LISTINGS:</b>	• UL 10C listed, 3-hour fire rated as auxiliary locks for A label single doors • UL 10B listed for neutral pressure doors

## PDQ Functions

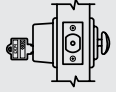
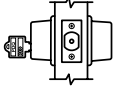
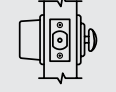
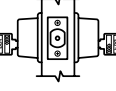
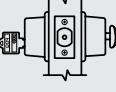
FUNCTION	FUNCTION NUMBER	OUTSIDE   INSIDE	DESCRIPTION	ANSI NUMBER
Entrance	116		<ul style="list-style-type: none"> <li>Lock or unlock by key from outside, by thumb turn from inside</li> </ul>	E1151
Single Cylinder	121		<ul style="list-style-type: none"> <li>Lock or unlock by key from outside</li> <li>Blank mortise cylinder on inside</li> </ul>	E1161
Single Sided	125		<ul style="list-style-type: none"> <li>Deadbolt by inside thumb turn only</li> <li>Blank mortise cylinder on outside</li> </ul>	E1112
Double Cylinder	137		<ul style="list-style-type: none"> <li>Lock or unlock by key from both sides</li> </ul>	E1141
Classroom	148		<ul style="list-style-type: none"> <li>Lock or unlock by key from outside</li> <li>Turnpiece inside retracts deadbolt, but will not project it</li> </ul>	E1171

## How to Order

QUANTITY	SERIES	FUNCTION	FINISH	BACKSET	CYLINDER	KEYWAY	KEYING
10	KT	116	626	234	D	SCC	KD
NOTE: Case quantity is 10 / Case weight is 19 lbs. Single Cylinder / Case weight is 22 lbs. Double Cylinder / For split finishes, designate O/S trim first, then I/S				<b>234</b> — 2-1/4" x 1-1/8" (Standard) <b>234R</b> — 2-1/4" x 1-1/8" x 1/4" Radius <b>234D</b> — Drive-in <b>238</b> — 2-1/4" x 1" <b>238R</b> — 2-1/4" x 1" x 1/4" Radius <b>238D</b> — Drive-in	<b>D</b> — Default <b>L</b> — Less Cylinder	PAGE 106	
				PAGE 106			

## Deadbolts

ANSI NO.	FUNCTION	DESCRIPTION	626	605/606/612 613E/625
<b>NON-CYLINDER</b>				
E1112	125	Communicating	\$132.00	\$144.00
<b>SINGLE CYLINDER</b>				
E1151	116	Entrance	\$175.00	\$187.00
E1171	148	Classroom		
E1161	121	Blank Single Cylinder		
<b>DOUBLE CYLINDER</b>				
E1141	137	Store Door	\$185.00	\$197.00

### NOTES:

- Consult Customer Service for availability of Split Finish
- 2-3/4" Latchbolt will be furnished with 2-1/4" x 1-1/8" faceplate unless otherwise stated
- 2-3/8" Latchbolt will be furnished with 2-1/4" x 1" face plate unless otherwise stated
- ADA thumbturn available special order

List prices shown include conventional key in knob/lever cylinder. For I-C, list prices do not include core.

## Backset

CODE	BACKSET DESCRIPTION	LOCK ADJUSTMENT
<i>2-3/4" Backset</i>		
234	2-1/4" x 1-1/8" (Standard)	N/C
234R	2-1/4" x 1-1/8" x 1/4" Radius	\$5.00
234D	Drive-in	N/C
<i>2-3/8" Backset</i>		
238	2-1/4" x 1" (Standard)	N/C
238R	2-1/4" x 1" x 1/4" Radius	\$5.00
238D	Drive-in	N/C

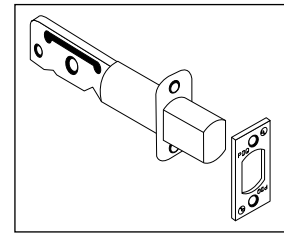

Bolt

KT SERIES  
DEADBOLT LOCKS

## Keyways and Mortise Cylinders

PDQ KEYWAY	COMPATIBLE WITH	SOLD WITH LOCK	
ARA	Arrow / AR1	N/C	
CO59A1	Corbin / 59A1		
CO6	Corbin / 60		
CL4	Corbin / L4		
RUD	Ruswin / D1		
SCE	Schlage / E		
SCC	Schlage / C		
SCC-K	Schlage / C-K		
SAL	Sargent / LA		
RA-RC	Sargent / RA-RC		
YA8	Yale / E1R		
GA	Yale / GA		
FAL	Falcon / E-R		
TA	PDQ / TA (Restricted. Limited to Grandmaster systems w/4 masters)		\$3.00
L	Less Cylinder		Deduct \$8/Cylinder

**NOTES:**

- Specify finish for Mortise Cylinders ordered separately

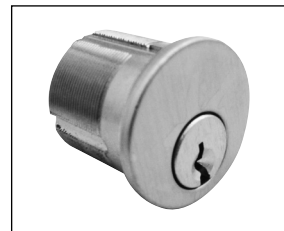

Mortise Cylinder

## Backset

BACKSET DESCRIPTION	PDQ NO.	LIST PRICE	
<b>2-3/4" Backset</b>			
2-1/4" x 1-1/8" (Default)	I4301	\$50.00	
2-1/4" x 1-1/8" x 1/4" Radius	I4301R		
Drive-in	I4201-5		
<b>2-3/8" Backset</b>			
2-1/4" x 1" (Default)	I4302		
2-1/4" x 1" x 1/4" Radius	I4302R		
Drive-in	I4202-5		

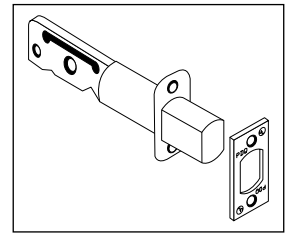

Bolt

KT SERIES  
DEADBOLT LOCKS

## Strikes

DESCRIPTION	605	613E	630	LIST PRICE
Deadbolt Strike 2-3/4" x 1-1/8"	I46021-5	I46021-6	I46021-1	\$25.00
Dust Box	I4587			\$8.00

## Typical Applications

- Light Commercial Installations
- Low Security Applications
- Residential

Deadbolts are Grade Comparable with SD Series Grade 2 Cylindrical Locks

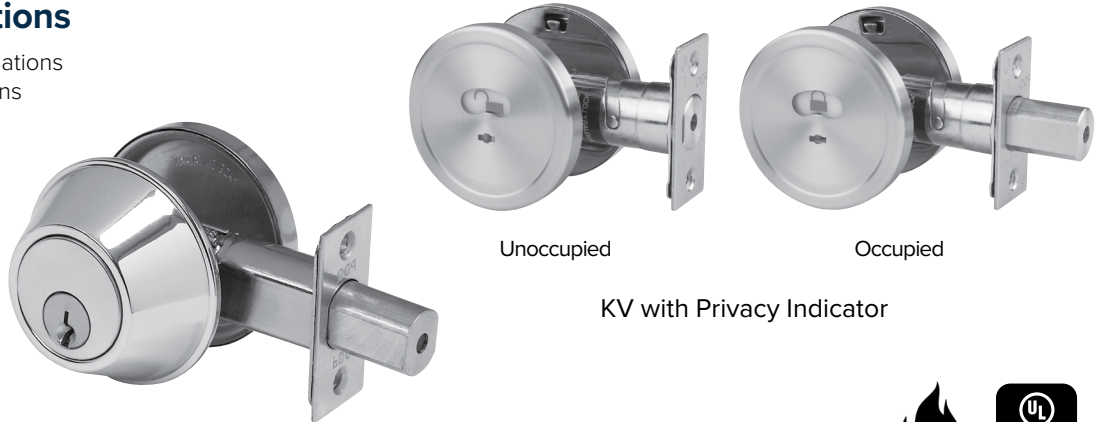

Unoccupied

Occupied

KV with Privacy Indicator



## Specifications

<b>FOR DOORS:</b>	• 1-3/8" to 1-3/4" thick for Conventional Cylinder, 1-1/2" to 2" for SFIC
<b>DOOR PREP:</b>	• 2-1/8" DIA
<b>BACKSET:</b>	• 2-3/4"/2-3/8" adjustable (Default)
<b>FRONT:</b>	• 2-1/4" x 1" with filler plate • Stainless Steel or Wrought Brass
<b>STRIKE:</b>	• 2-3/4" x 1" • Stainless Steel or Wrought Brass • Dust Box Included
<b>DEADBOLT:</b>	• 1" Throw • Brass Bolt containing one 1/4" case-hardened Steel Roll Pin
<b>HAND:</b>	• Non-handed
<b>TRIM:</b>	• Stainless Steel or Wrought Brass Scalp
<b>KEYS:</b>	• Two (2) per Lock
<b>KEYWAYS:</b>	• SCC standard (Schlage C Compatible) • Also available in keyways of other manufacturers
<b>INTERCHANGEABLE CORE:</b>	• 6 or 7-pin • Compatible with Best, Falcon and Arrow
<b>CYLINDER:</b>	• 6-pin Brass Insert Cylinder keyed to 5-pins • Standard High Security and UL437 Cylinders Available
<b>KEYING:</b>	• Options: MK, CMK or GMK • Zero Bitted (KO), Keyed Different (KD) or Keyed Alike (KA) • Can be keyed into existing master key systems
<b>FINISHES:</b>	• 605 (US3), 606 (US4), 612 (US10), 613E, 622 (US19), 629 (US32), 630 (US32D)
<b>CERTIFICATIONS, LISTINGS, COMPLIANCES:</b>	• ANSI "Positive Pressure Fire Tests of Door Assemblies" for up to and including 3 hrs. • Complies with ADA (Americans with Disabilities Act) and ICC/ANSI 117.1 for Accessible and Usable Building • UL 10C listed, 3-hour fire rated as auxiliary locks for A label single doors • UL 10B listed for neutral pressure doors • TAA compliant. Country of origin: KR
<b>WARRANTY:</b>	• One (1) year Limited Warranty

## PDQ Functions

FUNCTION	FUNCTION NUMBER	OUTSIDE   INSIDE	DESCRIPTION	ANSI NUMBER
Single Cylinder	116		<ul style="list-style-type: none"> <li>Lock or unlock by key from outside, by thumb turn from inside</li> </ul>	E2152
Single Sided	125		<ul style="list-style-type: none"> <li>Deadbolt by inside thumb turn only</li> <li>Special door preparation required</li> <li>Surface mounted, 1-3/4" bore hole, one side</li> </ul>	E2192
Single Sided	125 BK		<ul style="list-style-type: none"> <li>Deadbolt by inside thumb turn only</li> <li>2-1/8" bore hole, one side</li> </ul>	E21112
Single Sided Indicator Deadbolt	125 IND		<ul style="list-style-type: none"> <li>No key outside</li> <li>Indicator outside</li> <li>Thumbturn inside extends/retracts deadbolt</li> <li>Emergency key outside retracts deadbolt</li> </ul>	—
Double Cylinder	137		<ul style="list-style-type: none"> <li>Lock or unlock by key from both sides</li> </ul>	E2142

## How to Order

QUANTITY	SERIES	FUNCTION	FINISH	BACKSET	CYLINDER	KEYWAY	KEYING	OPTION
20	KV	116	630	ADJ	D	SCC	KD	—
NOTE: Case quantity is 20 / Case weight is 26 lbs. Single Cylinder / Case weight is 35 lbs. Double Cylinder			<b>605</b> <b>606</b> <b>613E</b> <b>622</b> <b>626</b> <b>630</b>	<b>ADJ</b> — 2-1/4" x 1" (Default) <b>ADJR</b> — 2-1/4" x 1" x 1/4" Radius	<b>D</b> Default <b>L</b> Less Cylinder <b>SF6</b> Lock is SFIC prepped w/ 6 pin core <b>SF7</b> Lock is SFIC prepped w/ 7 pin core <b>SFL</b> Lock is SFIC prepped but less core <b>SFC</b> Lock is SFIC prepped w/ construction core <b>SFP</b> Lock is SFIC prepped w/ plastic construction core	PAGE 110		<b>DB</b> — Dust Box
				PAGE 110	PAGE 110			PAGE 110

## Deadbolts

ANSI NO.	FUNCTION	DESCRIPTION	626/630	605/606/613E 622	CYLINDER OPTIONS	ICON	LOCK ADJUSTMENT
<b>NON-CYLINDER - Thumbturn Inside</b>							
E2192	125	Communicating	\$55.00	\$67.00	D		N/C
E21112	125BK	Communicating					
	125IND	Single Sided Indicator Deadbolt	\$77.00	\$89.00*			
<b>SINGLE CYLINDER - Cylinder Outside / Thumbturn Inside</b>							
E2152	116	Entrance	\$80.00	\$92.00	SFL		
<b>DOUBLE CYLINDER</b>							
E2142	137**	Store Door	\$102.00	\$114.00			

List prices shown include conventional key in knob/lever cylinder. For I-C, list prices do not include core.  
 \*125IND available in 626, 613E, 630 only \*\*Not available in SFL

**NOTES:**

- Prices do not include IC Core
- 125 different prep
- 125BK different prep

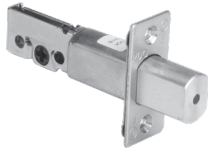

## Backset

BACKSET DESCRIPTION	605	613E	622	630	LIST PRICE
<i>2-3/4" - 2-3/8" ADJUSTABLE</i>					
2-1/4" x 1-1/8" (Default)	I04507-5	I04507-6	I04507-H	I04507-1	\$50.00
2-1/4" x 1-1/8" x 1/4" Radius	I04507-5R	I04507-6R	I04507-H	I04507-1R	
1-1/8" Latch Front Filler Plate (Minimum of 100 pieces)	I099-100				\$5.00

KV SERIES  
DEADBOLT LOCKS

## Options

DESCRIPTION	605	613E	622	630	LIST PRICE
Deadbolt Strike (any finish) 2-3/4" x 1-1/8"	I4702-5	I4702-6	I4702-H	I4702-1	\$25.00
Dust Box	I4701				\$8.00

## Miscellaneous Parts

DESCRIPTION	PDQ NO.	LIST PRICE
Emergency Release Key for KV125IND Deadbolt	I4711-EKEY	\$5.00



# MJ SERIES

# Heavy Duty Mortise Cylinder Deadbolt



ASSEMBLED  
IN THE USA

## Typical Applications

- Auxiliary Doors
- Closets
- Commercial/Institutional/Military
- Common Areas
- Equipment Rooms
- Storerooms
- Restrooms
- Privacy Rooms



## Specifications

Small Mortise Body Type Prep



<b>FOR DOORS:</b>	• 1-3/4"
<b>BACKSET:</b>	• 2-3/4"
<b>CASE:</b>	• Steel — Dichromated for corrosion resistance
<b>FACEPLATE:</b>	• 1-1/4" x 5-5/8"
<b>STRIKE:</b>	• 2-1/4" x 1" • Stainless Steel.
<b>DEADBOLT:</b>	• 1" Throw. • Stainless Steel.
<b>THUMBTURN OPTION:</b>	• ADA Compliant.
<b>INDICATOR:</b>	• Vacant/Occupied available.
<b>HAND:</b>	• Non-handed except for function MJ134 Classroom. (See Function Table and How to Order Guide).
<b>KEYS:</b>	• Two (2) per Lock.
<b>KEYWAYS:</b>	• SCC standard (Schlage C Compatible) • Also available in keyways of other manufacturers
<b>INTERCHANGEABLE CORE:</b>	• 6 or 7-pin • Compatible with Best, Falcon & Arrow • Large Format IC Cores compatible with Schlage.
<b>CYLINDER:</b>	• 6 or 7-pin Mortise Cylinder
<b>KEYING:</b>	• Options: MK, CMK or GMK • Zero Bitted (KO), Keyed Different (KD) or Keyed Alike (KA) • Can be keyed into existing master key systems
<b>FINISHES:</b>	• 605 (US3), 606 (US4), 612 (US10), 613E, 622 (US19), 629 (US32), 630 (US32D)
<b>CERTIFICATIONS, LISTINGS, COMPLIANCES:</b>	• UL listed for 3 hours, for single doors up to 4'0"x 8'0" • TAA compliant. Country of origin: Taiwan
<b>WARRANTY:</b>	• 10-Year Limited Warranty

## Cross Reference\*

ANSI # A156.5 (A156.13)	PDQ FUNCTION	BEST	CORBIN	DORMA	MARKS #31/32/33 SERIES	SARGENT	SCHLAGE	ACCENTRA
E06081 (F18)	MJ131	48H L	DL4111	D961	L	4876	L464	353
E06071 (F17)	MJ132	48H K	DL4113	D960	K	4875	L460	352
E06061 (F16)	MJ133	48H M	DL4112	D962	M	4874	L462	351
E06091 (F29)	MJ134LH	48H R	DL4117	D963	S	4877	L463	357
	MJ134LH							

\*Note: Functions are equal, but form may differ.



## How to Order

SERIES	FUNCTION	FINISH	CYLINDER	KEYWAY OR HOUSING	KEYING	OPTIONS
MJ	131	630	D	SCC	KD	—
		<b>605</b> <b>606</b> <b>612</b> <b>613E</b> <b>622</b> <b>629</b> <b>630</b>	<b>D</b> Default <b>L</b> Less Cylinder <b>SF6</b> Lock is SFIC prepped w/ 6 pin core <b>SF7</b> Lock is SFIC prepped w/ 7 pin core <b>SFL</b> Lock is SFIC prepped but less core <b>SFC</b> Lock is SFIC prepped w/ construction core <b>SFP</b> Lock is SFIC prepped w/ plastic construction core <b>LF6</b> Lock is Schlage LFIC prepped w/ Schlage core <b>LFL</b> Lock is Schlage LFIC prepped but less core <b>LFC</b> Lock is Schlage LFIC prepped w/ construction core			<b>ADA</b> — Disability Thumbturn (ADA) <b>AM</b> — Antimicrobial Coating

## Mortise Deadbolt

FUNCTION	FUNCTION NUMBER	OUTSIDE   INSIDE	DESCRIPTION	630	605/606/613E/629 /612/622
Single Cylinder	131		<ul style="list-style-type: none"> <li>Key outside extends/retracts deadbolt</li> </ul>	\$272.00	\$284.00
Single Cylinder with Thumbturn	132		<ul style="list-style-type: none"> <li>Key outside extends/retracts deadbolt</li> <li>Thumbturn inside extends/retracts deadbolt</li> </ul>	\$343.00	\$355.00
Double Cylinder	133		<ul style="list-style-type: none"> <li>Key outside extends/retracts deadbolt</li> <li>Key inside extends/retracts deadbolt</li> </ul>	\$399.00	\$411.00
Single Cylinder (Classroom) Left Hand	134LH		<ul style="list-style-type: none"> <li>Key outside extends/retracts deadbolt</li> <li>Inside cylinder turn retracts but does not extend deadbolt</li> <li>Thumbturn rotates clockwise</li> </ul>	\$373.00	\$385.00
Single Cylinder (Classroom) Right Hand	134RH		<ul style="list-style-type: none"> <li>Key outside extends/retracts deadbolt</li> <li>Inside cylinder turn retracts but does not extend deadbolt</li> <li>Thumbturn rotates counter-clockwise</li> </ul>		
Single Cylinder w/Indicator (Privacy)	232		<ul style="list-style-type: none"> <li>Key outside extends/retracts deadbolt</li> <li>Thumb turn inside extends/retracts deadbolt</li> <li>Indicator outside displays:                             <ul style="list-style-type: none"> <li>Occupied when deadbolt is projected</li> <li>Vacant when deadbolt is retracted</li> </ul> </li> <li>Indicator, outside — (VACANT/OCCUPIED)</li> </ul>	\$452.00	\$464.00

Note: For replacement T-Turn mortise cylinders for functions MJ134 RH and MJ134 LH, see the Cylinders and Keying Section.

## Options

CODE	DESCRIPTION	LIST PRICE
ADA	Disability Thumbturn (ADA)	\$21.00
AM	Antimicrobial Coating (Not available with 605 finish)	\$37.00



ADA Thumbturn



**PL-1 IC PADLOCK**

Solid brass padlock with hardened steel shackle, accepts standard 6 or 7 pin SFIClock cylinders (sold separately).

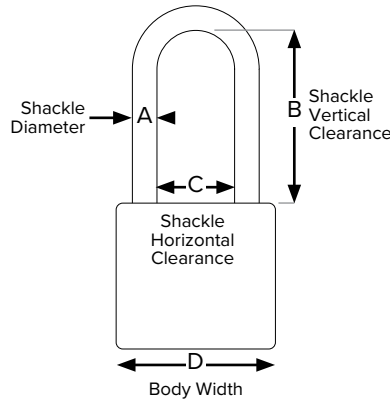

**SHACKLE DIMENSIONS**

### Typical Applications

- Gates
- Higher Education
- Industrial
- K-12 Education

### How to Order

QUANTITY	SERIES / SHACKLE DIAMETER	SHACKLE HEIGHT	CORE PREP	FINISH	CHAIN OPTIONS	OPTION
10	PL1 - 1/4" (Only available in 1 1/2" shackle height with frangible shackle) PL2 - 5/16" PL3 - 3/8"	A - (3/4") B - (1 1/2") C - (2") D - (4")	SF7L	626	CC	FS - Frangible Shackle (available on model PL1-B only) SS - Stainless Steel Shackle **Special order only

NOTE: Case quantity is 6 / Case weight varies

### Padlock Sizing Chart

MODEL	DIMENSION A	DIMENSION B	DIMENSION C	DIMENSION D	LIST PRICE
PL1-B SF7L 626 FS	1/4"	1 1/2"	25/32"	1 19/32"	\$100.00
PL2-A SF7L 626	5/16"	3/4"	25/32"	1 3/4"	\$70.00
PL2-B SF7L 626	5/16"	1 1/2"	25/32"	1 3/4"	\$75.00
PL2-C SF7L 626	5/16"	2"	25/32"	1 3/4"	\$80.00
PL2-D SF7L 626	5/16"	4"	25/32"	1 3/4"	\$115.00
PL3-A SF7L 626	3/8"	3/4"	25/32"	1 31/32"	\$85.00
PL3-B SF7L 626	3/8"	1 1/2"	25/32"	1 31/32"	\$90.00
PL3-C SF7L 626	3/8"	2"	25/32"	1 31/32"	\$95.00
PL3-D SF7L 626	3/8"	4"	25/32"	1 31/32"	\$130.00

**NOTES:**

- Prices do not include IC Core

### Options

CODE	DESCRIPTION	PDQ NO.	LIST PRICE
CC	Chain & Clevis	I8512	ADD \$15.00
SS	Stainless Steel Shackle **Special order only	STSHACKLE	ADD \$50.00

### Cores

DESCRIPTION	PDQ NO.	ADD
<b>SMALL FORMAT UNCOMBINATED</b>		
6 Pin Cores	I5206 + KEYWAY (I5206-A)	\$40.00
7 Pin Cores	I5207 + KEYWAY (I5207-B)	
<b>COMBINATED</b>		
6 Pin Cores	I5206-1 + KEYWAY (I5206-1A)	\$60.00
7 Pin Cores	I5207-1 + KEYWAY (I5207-1B)	
A (DEFAULT), B, C, D, E, F, G, H, J, K, L, M, Q, WA, WB, WC, WG, WH, TB, TD, TE, & R		
<b>CONSTRUCTION CORES</b>		
Construction Core 6-pin only		\$60.00
<b>Dummy Construction Core Plastic</b> Construction cores are invoiced at shipment and credited upon return. Subject to 50% discount.		\$8.00
<b>VISUAL KEY CONTROL</b>		LIST PRICE
Cylinder Marking AA1, AA2, Etc. (Per Cylinder)		\$10.00
Key Marking AA1, AA2, Etc. (Per Key)		
Key Marking other than Keyset (Per Key)		

**NOTES:**

- IC Cores are available Combined or Uncombined
- Uncombined cores do not include springs & pins
- Combined cores includes master keying
- Designate finish for IC Cores ordered separately: 606 or 626

### Features

- PDQ EPIC Series cylinders include a special format interchangeable core to retrofit into standard European Profile applications.
- Solid brass construction
- Can be incorporated into existing master key system
- Large thumbturn for ease of use
- EPIC Cores receive special machining to interface with housing. Specify (EP) designator for these cores (example: I5206EP-A)



EPIC SERIES

PDQ NO.	DESCRIPTION	LIST PRICE
I5131	EPIC, Single Cylinder 45MM	\$222.00
I5131L	EPIC, Single Cylinder 55MM	\$245.00
I5132	EPIC, Single Cylinder X Turn 45MM/40MM	\$260.00
I5132LIS	EPIC, Single Cylinder X Turn 45MM/55MM	\$282.00
I5132LOS	EPIC, Single Cylinder X Turn 55MM/45MM	
I5133	EPIC, Double Cylinder 45MM/45MM	\$260.00
I5133L	EPIC, Double Cylinder 55MM/45MM	\$292.00

### Cores

DESCRIPTION	PDQ NO.	ADD
<b>SMALL FORMAT UNCOMBINATED</b>		
6 Pin Cores	I5206 + KEYWAY (I5206EP-A)	\$150.00
7 Pin Cores	I5207 + KEYWAY (I5207EP-B)	
<b>COMBINATED</b>		
6 Pin Cores	I5206-1 + KEYWAY (I5206EP-1A)	\$180.00
7 Pin Cores	I5207-1 + KEYWAY (I5207EP-1B)	
A (DEFAULT), B, C, D, E, F, G, H, J, K, L, M, Q, WA, WB, WC, WG, WH, TB, TD, TE, & R		
<b>CONSTRUCTION CORES</b>		
Construction Core 6-pin only		\$150.00
Dummy Construction Core Plastic Construction cores are invoiced at shipment and credited upon return. Subject to 50% discount.		\$6.00
<b>VISUAL KEY CONTROL</b>		LIST PRICE
Cylinder Marking AA1, AA2, Etc. (Per Cylinder)		\$10.00
Key Marking AA1, AA2, Etc. (Per Key)		
Key Marking other than Keyset (Per Key)		

**NOTES:**

- IC Cores are available Combined or Uncombined
- Uncombined cores do not include springs & pins
- Combined cores includes master keying
- Designate finish for IC Cores ordered separately: 606 or 626

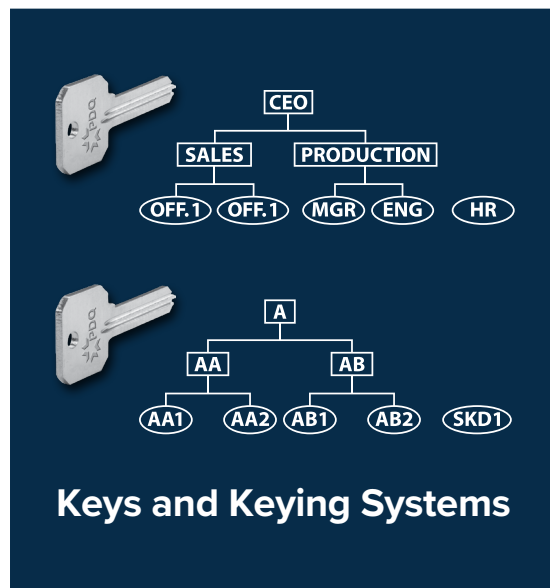
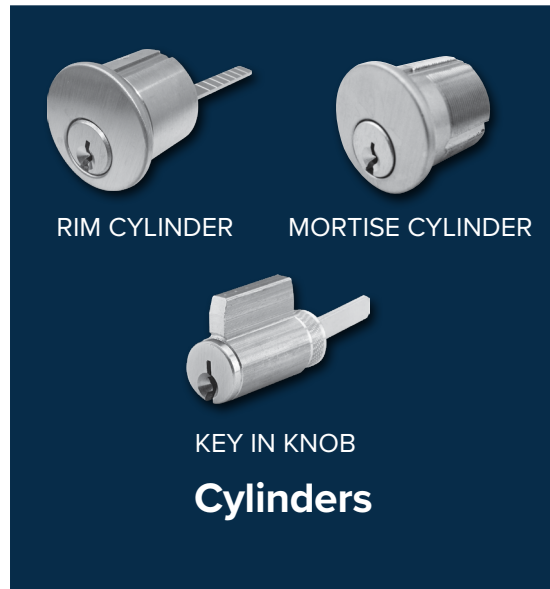

# HIGH SECURITY

## LIST PRICE

Effective July 3, 2023

### Standard High Security Cylinders

DESCRIPTION	PDQ NO.	626	605	613E
6 Pin Key in Knob/Lever Cylinder KD/KA	HSC125	\$86.00	\$106.00	—
Mortise/Rim Combo Cylinder 1-1/8" 6 Pin KD/KA	HSC020	\$118.00	\$138.00	
Mortise Cylinder 1 1/4" 6 Pin KD/KA	HSC030			
Mortise Cylinder 1 1/2" 6 Pin KD/KA	HSC050	\$150.00	—	

Includes 2 Cut Keys. NOTE: Requires master keying, see below for charge.

#### NOTES:

- Prices for LFIC Mortise & Rim Cylinder Housings do not include IC Core
- Specify finish when ordering IC Housing & Cores
- High Security Cylinders not available "0" bitted.
- Key blanks for High Security Cylinders not available.

### UL437 High Security Cylinders

DESCRIPTION	PDQ NO.	626	605	613E
UL 437 6 Pin Key in Knob/Lever Cylinder KD/KA	HSC425	\$105.00	\$139.00	—
UL 437 Mortise Rim Combo Cylinder 1-1/8" KD/KA	HSC320	\$140.00	\$174.00	
UL 437 Mortise Cylinder 1-1/4" KD/KA	HSC330			

Includes 2 Cut Keys. NOTE: Requires master keying, see below for charge.

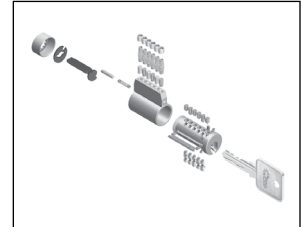

High Security Cylinder

### High Security Keying Systems

DESCRIPTION	PDQ NO.	LIST PRICE
Cut Key, 6 pin	HSC065	\$15.00
SFIC Cut Key, IC 7 pin	HSC874	
LFIC Control Cut Key, IC 6 pin, TA	HSC965	
Master Keying Charge		\$24.00
Key Marking Charge		\$6.00
Cylinder Marking Charge		\$12.00

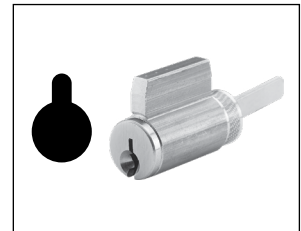

Key in Knob/Lever Cylinder

### High Security Cores

DESCRIPTION	PDQ NO.	626
SFIC Cylinder, 6 Pin	HSC806	\$118.00
SFIC Cylinder, 7 Pin	HSC807	\$128.00
LFIC Cylinder Schlage® compatible, 6 Pin	HSC906	\$172.00

Includes Keying Charges and 2 Cut Keys

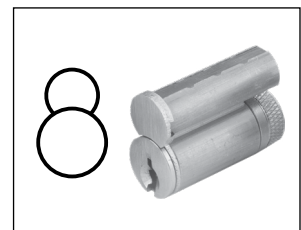
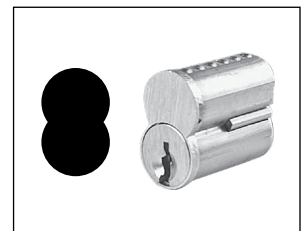

### High Security Cams

DESCRIPTION	PDQ NO.	LIST PRICE
Adams Rite Type Cam	HSCCAM1	\$9.00
Yale Type Cam	HSCCAM2	
Yale Narrow Type Cam	HSCCAM2A	
Russwin Type Cam	HSCCAM3	
Falcon Type Cam	HSCCAM4	
Schlage Type Cam	HSCCAM7	
Sargent Offset Type Cam	HSCCAM8	
PDQ Cam	HSCCAM3	

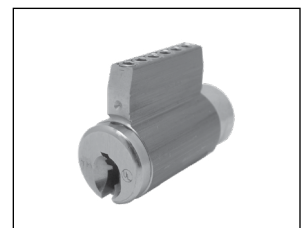

UL 437 and High Security Cylinders



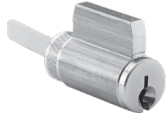

Conventional

### Conventional Cylinders

PDQ's high quality conventional cylinders provide the standard level of security and functionality.

### Interchangeable Core (IC) cylinders

Interchangeable core (IC) offers maximum flexibility to the building owner. Whenever a key is lost or stolen, locks can be rekeyed quickly by non-locksmith personnel. All it takes is the special "control" key. This key is used to remove and install all cores in the system. Just go to the door, remove the old core and install the new one with the control key. Security is regained in seconds! Unlike most other brands, PDQ interchangeable cores can always be integrated into existing systems with no adverse effect on the key system. IC cylinders are available in two sizes:



SFIC

#### Small Format Interchangeable Core (SFIC)

Based on a plug diameter smaller than the standard 1/2", SFIC cores are interchangeable with other SFIC installations.



LFIC

#### Large Format Interchangeable Core (LFIC)

Based on the industry standard plug diameter of 1/2", PDQ large format interchangeable cores (LFIC) are available for a variety of different key system types from standard and basic, to restricted and high security.



High security key in knob cylinder

### Standard High Security Cylinders

#### Conventional Key in Knob

#### Interchangeable Core - SFIC and LFIC

PDQ High Security cylinders are available in a number of formats, including the standard, KIK (Key In Knob or lever) cylinder used in most PDQ cylindrical locks, as well as a unique Mortise/Rim Cylinder that can be used in either configuration. All standard High Security cylinders feature 2 hardened anti-drill pins as well as our unique and proprietary PDQ keyway with sidebar.



High security SFIC and LFIC cores (SFIC shown)



UL 437 High Security Cylinders

### UL 437 High Security Cylinders **437**

For additional security, PDQ offers select cylinders in a UL437 package. These optional cylinders feature a minimum of 11 anti-drill, stainless steel pins and UL437 certification. UL437 available in all mortise, mortise rim and KIK keyed functions.

## Conventional Key in Knob/Lever Cylinders



KEYWAY	CODE	606	626	LIST PRICE
<b>PDQ TA (Restricted)</b>	<b>TA</b>	V90504-844	V90504-744	\$78.00
Arrow AR1	AR1	V90504-830	V90504-730	
Corbin 59A1	CO59A1	V90504-829	V90504-729	
Corbin 60	CO6	V90504-819	V90504-719	
Corbin L4	CL4	V90504-822	V90504-722	
Falcon E-R	FAL	V90504-833	V90504-733	
Kwikset	KW	V90504-850	V90504-750	
Russwin 981	RUD981	V90504-821	V90504-721	
Russwin D1	RUD	V90504-820	V90504-720	
Sargent LA	SAL	V90504-805	V90504-705	
Sargent RA-RC	RA-RC	V90504-806	V90504-706	
Schlage C (Default)	SCC (Default)	V4802-8	V4802-7	
Schlage C-K	SCC-K	V90504-818	V90504-718	
Schlage E	SCE	V90504-817	V90504-717	
Yale E1R	YA8	V90504-831	V90504-731	
Yale GA	GA	V90504-835	V90504-735	

**NOTES:**

- Specify finish for cylinders
- Specify KD, KA4, or 1 bitted
- 6 pin cylinder keyed for 5 pin
- Specify lock series.  
Example: GT, SD, etc.

# CYLINDERS

**LIST PRICE**

Effective July 3, 2023

## Rim Cylinders



KEYWAY	CODE	605	606	612	613E	625	626	LIST PRICE
<b>PDQ TA (Restricted)</b>	<b>TA</b>	I01705-6044	I01708-6044	I01703-6044	I01706-6044	I01702-6044	I01707-6044	\$84.00
Arrow AR1	AR1	I01705-6030	I01708-6030	I01703-6030	I01706-6030	I01702-6030	I01707-6030	
Corbin 59A1	CO59A1	I01705-6029	I01708-6029	I01703-6029	I01706-6029	I01702-6029	I01707-6029	
Corbin 60	CO6	I01705-6019	I01708-6019	I01703-6019	I01706-6019	I01702-6019	I01707-6019	
Corbin L4	CL4	I01705-6022	I01708-6022	I01703-6022	I01706-6022	I01702-6022	I01707-6022	
Falcon E-R	FAL	I01705-6033	I01708-6033	I01703-6033	I01706-6033	I01702-6033	I01707-6033	
Kwikset	KW	I01705-6050	I01708-6050	I01703-6050	I01706-6050	I01702-6050	I01707-6050	
Russwin 981	RUD981	I01705-6021	I01708-6021	I01703-6021	I01706-6021	I01702-6021	I01707-6021	
Russwin D1	RUD	I01705-6020	I01708-6020	I01703-6020	I01706-6020	I01702-6020	I01707-6020	
Sargent LA	SAL	I01705-605	I01708-605	I01703-605	I01706-605	I01702-605	I01707-605	
Sargent RA-RC	RA-RC	I01705-606	I01708-606	I01703-606	I01706-606	I01702-606	I01707-606	
Schlage C (Default)	SCC (Default)	I01705-6016	I01708-6016	I01703-6016	I01706-6016	I01702-6016	I01707-6016	
Schlage C-K	SCC-K	I01705-6018	I01708-6018	I01703-6018	I01706-6018	I01702-6018	I01707-6018	
Schlage E	SCE	I01705-6017	I01708-6017	I01703-6017	I01706-6017	I01702-6017	I01707-6017	
Yale E1R	YA8	I01705-6031	I01708-6031	I01703-6031	I01706-6031	I01702-6031	I01707-6031	
Yale GA	GA	I01705-6035	I01708-6035	I01703-6035	I01706-6035	I01702-6035	I01707-6035	
-----	Dummy	I01705-60D	I01708-60D	I01703-60D	I01706-60D	I01702-60D	I01707-60D	

# CYLINDERS

# LIST PRICE

Effective July 3, 2023

## Mortise Cylinders



LENGTH INCLUDES CAM

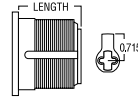

KEYWAY	PDQ KEYWAY	CYLINDER LENGTH	605	606	612	613E	625	626	630	LIST PRICE
Arrow AR1	AR1	15/16"	I01605-7030	I01608-7030	I01603-7030	I01606-7030	I01602-7030	I01601-7030	—	\$102.00
		1-1/8"	I01605-7130	I01608-7130	I01603-7130	I01606-7130	I01602-7130	I01601-7130	—	
		1-1/4"	I01605-7230	I01608-7230	I01603-7230	I01606-7230	I01602-7230	I01601-7230	—	
Corbin 59A1	C59A1	15/16"	I01605-7029	I01608-7029	I01603-7029	I01606-7029	I01602-7029	I01601-7029	—	
		1-1/8"	I01605-7129	I01608-7129	I01603-7129	I01606-7129	I01602-7129	I01601-7129	—	
		1-1/4"	I01605-7229	I01608-7229	I01603-7229	I01606-7229	I01602-7229	I01601-7229	—	
Corbin 60	CO6	15/16"	I01605-7019	I01608-7019	I01603-7019	I01606-7019	I01602-7019	I01601-7019	—	
		1-1/8"	I01605-7119	I01608-7119	I01603-7119	I01606-7119	I01602-7119	I01601-7119	—	
		1-1/4"	I01605-7219	I01608-7219	I01603-7219	I01606-7219	I01602-7219	I01601-7219	—	
Corbin L4	CL4	15/16"	I01605-7022	I01608-7022	I01603-7022	I01606-7022	I01602-7022	I01601-7022	—	
		1-1/8"	I01605-7122	I01608-7122	I01603-7122	I01606-7122	I01602-7122	I01601-7122	—	
		1-1/4"	I01605-7222	I01608-7222	I01603-7222	I01606-7222	I01602-7222	I01601-7222	—	
Russwin D1	RUD	15/16"	I01605-7020	I01608-7020	I01603-7020	I01606-7020	I01602-7020	I01601-7020	—	
		1-1/8"	I01605-7120	I01608-7120	I01603-7120	I01606-7120	I01602-7120	I01601-7120	—	
		1-1/4"	I01605-7220	I01608-7220	I01603-7220	I01606-7220	I01602-7220	I01601-7220	—	
Russwin 981	RUD981	15/16"	I01605-7021	I01608-7021	I01603-7021	I01606-7021	I01602-7021	I01601-7021	—	
		1-1/8"	I01605-7121	I01608-7121	I01603-7121	I01606-7121	I01602-7121	I01601-7121	—	
		1-1/4"	I01605-7221	I01608-7221	I01603-7221	I01606-7221	I01602-7221	I01601-7221	—	
Schlage E	SCE	15/16"	I01605-7017	I01608-7017	I01603-7017	I01606-7017	I01602-7017	I01601-7017	—	
		1-1/8"	I01605-7117	I01608-7117	I01603-7117	I01606-7117	I01602-7117	I01601-7117	—	
		1-1/4"	I01605-7217	I01608-7217	I01603-7217	I01606-7217	I01602-7217	I01601-7217	—	
Schlage C	SCC	15/16"	I01605-7016	I01608-7016	I01603-7016	I01606-7016	I01602-7016	I01601-7016	—	
		1-1/8"	I01605-7116	I01608-7116	I01603-7116	I01606-7116	I01602-7116	I01601-7116	—	
		1-1/4"	I01605-7216	I01608-7216	I01603-7216	I01606-7216	I01602-7216	I01601-7216	—	
		1-1/2"	I01605-7316	I01608-7316	I01603-7316	I01606-7316	I01602-7316	I01601-7316	—	
Schlage C-K	SCC-K	15/16"	I01605-7018	I01608-7018	I01603-7018	I01606-7018	I01602-7018	I01601-7018	—	
		1-1/8"	I01605-7118	I01608-7118	I01603-7118	I01606-7118	I01602-7118	I01601-7118	—	
		1-1/4"	—	I01608-7218	I01603-7218	I01606-7218	I01602-7218	I01601-7218	—	
Sargent LA	SAL	15/16"	I01605-705	I01608-705	I01603-705	I01606-705	I01602-705	I01601-705	—	
		1-1/8"	I01605-715	I01608-715	I01603-715	I01606-715	I01602-715	I01601-715	—	
		1-1/4"	I01605-725	I01608-725	I01603-725	I01606-725	I01602-725	I01601-725	—	
Sargent RA-RC	RA-RC	15/16"	I01605-706	I01608-706	I01603-706	I01606-706	I01602-706	I01601-706	—	
		1-1/8"	I01605-716	I01608-716	I01603-716	I01606-716	I01602-716	I01601-716	—	
		1-1/4"	I01605-726	I01608-726	I01603-726	I01606-726	I01602-726	I01601-726	—	
Yale E1R	YA8	15/16"	I01605-7031	I01608-7031	I01603-7031	I01606-7031	I01602-7031	I01601-7031	—	
		1-1/8"	I01605-7131	I01608-7131	I01603-7131	I01606-7131	I01602-7131	I01601-7131	—	
		1-1/4"	I01605-7231	I01608-7231	I01603-7231	I01606-7231	I01602-7231	I01601-7231	—	
Yale GA	GA	15/16"	I01605-7035	I01608-7035	I01603-7035	I01606-7035	I01602-7035	I01601-7035	—	
		1-1/8"	I01605-7135	I01608-7135	I01603-7135	I01606-7135	I01602-7135	I01601-7135	—	
		1-1/4"	I01605-7235	I01608-7235	I01603-7235	I01606-7235	I01602-7235	I01601-7235	—	
Falcon E-R	FAL	15/16"	I01605-7033	I01608-7033	I01603-7033	I01606-7033	I01602-7033	I01601-7033	—	
		1-1/8"	I01605-7133	I01608-7133	I01603-7133	I01606-7133	I01602-7133	I01601-7133	—	
		1-1/4"	I01605-7233	I01608-7233	I01603-7233	I01606-7233	I01602-7233	I01601-7233	—	
Kwikset	KW	15/16"	I01605-7050	I01608-7050	I01603-7050	I01606-7050	I01602-7050	I01601-7050	—	
		1-1/8"	I01605-7150	I01608-7150	I01603-7151	I01606-7150	I01602-7150	I01601-7150	—	
		1-1/4"	I01605-7250	I01608-7250	I01603-7250	I01606-7250	I01602-7250	I01601-7250	—	
PDQ TA (Restricted. Limited to Grand-master systems w/4 masters)	TA	15/16"	I01605-7044	I01608-7044	I01603-7044	I01606-7044	I01602-7044	I01601-7044	—	
		1-1/8"	I01605-7144	I01608-7144	I01603-7144	I01606-7144	I01602-7144	I01601-7144	—	
		1-1/4"	I01605-7244	I01608-7244	I01603-7244	I01606-7244	I01602-7244	I01601-7244	—	
		1-1/2"	I01605-7344	I01608-7344	I01603-7344	I01606-7344	I01602-7344	I01601-7344	—	
—	Dummy	1"	I01605-70D	I01608-70D	I01603-70D	I01606-70D	I01602-70D	I01601-70D	—	
		1-1/8"	I01605-71D	I01608-71D	I01603-71D	I01606-71D	I01602-71D	I01601-71D	—	
		1-1/4"	I01605-72D	I01608-72D	I01603-72D	I01606-72D	I01602-72D	I01601-72D	—	
—	T-Turn	15/16"	—	—	—	—	—	—	—	
		1-1/8"	I12605	I12608	I12603	I12606	I12602	I12607	—	
		1-1/4"	I22605	I22608	I22603	I22606	I22602	I22607	—	
—	T-Turn, Right Hand, Function MJ134 RH	1-1/4"	—	—	—	—	—	—	MJ522-01	
—	T-Turn, Left Hand, Function MJ134 LH	1-1/4"	—	—	—	—	—	—	MJ523-01	

# INTERCHANGEABLE CORES

**LIST PRICE**  
Effective July 3, 2023



## Interchangeable Cores

CORE TYPE	KEYWAY	PDQ KEYWAY	ADD	PINS	606	626
Small Format (SFIC) BEST Compatible	<b>UNCOMBINATED</b>					
	Best A (Default), B, C, D, E, F, G, H, J, K, L, M, Q, R, WA, WB, WG, WH, TB, TD, TE	A (Default), B, C, D, E, F, G, H, J, K, L, M, Q, R, WA, WB, WG, WH, TB, TD, TE	\$40.00	6	I5206 - 8 - Specify Keyway	I5206 - 7 - Specify Keyway
				7	I5207 - 8 - Specify Keyway	I5207 - 7 - Specify Keyway
	<b>COMBINATED</b>					
	Best A (Default), B, C, D, E, F, G, H, J, K, L, M, Q, R, WA, WB, WG, WH, TB, TD, TE	A (Default), B, C, D, E, F, G, H, J, K, L, M, Q, R, WA, WB, WG, WH, TB, TD, TE	\$60.00	6	I5206 - 8-1- Specify Keyway	I5206 - 7-1- Specify Keyway
				7	I5207 - 8-1- Specify Keyway	I5207 - 7-1- Specify Keyway
	PDQ Exclusive	PDQ 1	\$60.00	6	I5206 - 8 - 41	I5206 - 7 - 41
		PDQ 2		7	I5207 - 8 - 41	I5207 - 7 - 41
	PDQ Exclusive and Restricted	PDQ 3	\$60.00	6	I5206 - 8 - 42	I5206 - 7 - 42
				7	I5207 - 8 - 42	I5207 - 7 - 42
Large Format (LFIC) Schlage Compatible	<b>UNCOMBINATED</b>					
	Schlage C (Default)	SCC (Default)	\$50.00	6	I5206-8-16	I5206-7-16
Large Format (LFIC) Schlage Compatible	<b>COMBINATED</b>					
	Schlage C (Default)	SCC (Default)	\$70.00	6	I5206-8-116	I5206-7-116
PDQ Restricted	TA	—		See High Security Section		
Construction Cores <sup>1</sup>	Small Format <sup>2</sup> (BEST Compatible)	—	\$60.00	6 only	I5206	I5206
	Dummy, Plastic	—	\$8.00	—	I13520	I13520
	Large Format (Schlage Compatible)	—	\$70.00	—	I5206LFIC	I5206LFIC
	I-C Tailpiece and Spacer	—	\$12.00	—	VP92905	VP92905

**Notes 1: No finish designation required. 2: Available in "L" keyway only.**



## Housings

DESCRIPTION	PDQ NO.	LIST PRICE
SFIC Mortise Cylinder Housing 6-pin 1-1/4", BEST <sup>®</sup> compatible	I5306-(specify finish)	\$75.00
SFIC Mortise Cylinder Housing 7-pin 1-3/8", BEST <sup>®</sup> compatible	I5307-(specify finish)	
SFIC Mortise Cylinder Housing (for both 6-pin/7-pin cores), 1-1/2", BEST <sup>®</sup> compatible	I5317-(specify finish)	
SFIC Mortise Cylinder Tapered 6-pin 1-1/2", BEST <sup>®</sup> compatible	I53013-067 (specify US3 or 26D)	
SFIC Mortise Cylinder Tapered 7-pin 1-1/2", BEST <sup>®</sup> compatible	I53013-077 (specify US10B or 26D)	
SFIC Rim Cylinder Housing (for both 6-pin/7-pin cores)	I5308-(specify finish)	\$90.00
LFIC Mortise Housing, Schlage <sup>®</sup> compatible	I5304-(specify finish)	
LFIC Rim Housing, Schlage <sup>®</sup> compatible	I5303-(specify finish)	

### Cams

CAM LAYOUT	DESCRIPTION	WHERE USED	CONVENTIONAL MORTISE CYLINDER	SMALL FORMAT HOUSING	LARGE FORMAT HOUSING	LIST PRICE
	Adams Rite AR Cam	KT Series Deadbolts	1127-4205	154011	154211	\$9.00
	PDQ MR Cam	MR Series Mortise Locks	1127-4201	154061	154261	
	Straight Cam	6 EW Series Wide Stile Escutcheon Exit Device Trim	1127-4204	154031	154231	
	Schlage Cloverleaf Cam		1127-4209	154051	154221	
	Sargent Std Cam		1127-4207	154041	N/A	
	Lockwood		1127-4203	154021	N/A	

## Keyways



### Standard (Open) Keyways

Best suited for applications where fast and easy key duplication is required and low key control is required.



### Exclusive Keyways (PDQ1, PDQ2)

PDQ offers two exclusive key systems that utilize key blanks that are very hard to find in the marketplace, thereby reducing the chances of unauthorized duplication.



### Restricted Keyways (TA, PDQ3)

The PDQ restricted keyway is only available from PDQ and is shipped directly to the authorized end user. Restricted key systems are ideal when there is a significant need to eliminate an unauthorized duplication by lock shops, hardware and home centers. They provide a higher level of security, with authorization required for the order of key blanks for duplication. Each key is registered and no blank keys are sold. A letter of authorization on the end user's stationery must be submitted with the initial order to establish the authorized ship to location.

## Key Blanks

### Conventional



### Large Bow

Ideal for special keys which must be visibly distinctive within a key system, or for very specialized marking.



Only available in Schlage C

### Interchangeable Core



## Construction Cores

Temporary construction cores are an excellent way to ensure the security of a construction site. Another more secure way to ensure the security of the construction site is the use of temporary cores. PDQ offers both standard and disposable construction cores for this purpose. The standard cores are painted black above the keyway identifying them as construction cores. These can be returned at job's end for a full credit. Disposable cores are not key lockable and are discarded when the job is complete.

## Construction Master Keying (CMK):

PDQ offers the CMK keying option which provides extra security during the transition from the construction phase to completion. A construction master key operates all PDQ cylinders while the building is under construction. Upon completion of the construction phase, it can be voided without removing the cylinders from the locks simply by turning the change key in each cylinder.

# KEYING SYSTEMS

**LIST PRICE**  
Effective July 3, 2023

CODE	KEYING SYSTEMS	LIST PRICE
KD	Keyed Random	N/C
OB	0-Bitted with 2 blank keys (For quality control purposes, PDQ "0" bit cylinders are actually keyed to a 1 bit and a 1 bit key is sent to open cylinders.)	
KA2	Keyed Alike, 2 or less (KA2)	
KA4	Keyed Alike, 3-4 (KA3 or KA4)	\$14.00 each
KA	Keyed Alike, 5 or More (KA5)	
MK	Master Keyed	\$24.00 each
KE	Master Keyed to Existing Bittings:	
CMK	Construction Master Keyed	\$42.00 each
CODE	MASTER KEY SERVICES	
	Number of Bittings	
B100	1-100	\$125.00
B300	101-300	\$190.00
B1000	301-1000	\$275.00
B2000	1001- 2000	\$375.00
B5000	2001- 5000	\$475.00
	Master Key Service is a custom master key system that is provided with the purchase of complete PDQ manufactured locks and locking devices. A master key service charge will be assessed for any order that includes only PDQ cylinders or cores for use on non-PDQ locks or locking devices.	
BL	Bitting List for Factory Master Key Production	\$110.00
CODE	VISUAL KEY CONTROL	
VKC-KEY	Visual Key Control - Key Stamping	\$6.00
VKC-CYL	Visual Key Control - Cylinder Stamping	\$12.00
VKC-COR	Visual Key Control - Core Stamping	
CODE	KEY CUT CHARGE – MASTER/CONTROL/CHANGE	
MKC	Master Key	\$15.00
GMKC	Grand Master Key	
GGMKC	Great Grand Master Key	
CMKC	Construction Master Key	
CTLK	Control Key	
CKC	Change Key	
CODE	EXTRA KEY CUTS	
IO 24 05-00	Extra Key Cuts	



Visual Key Control



# LOCK AND KEY PARTS

## LIST PRICE

Effective July 3, 2023

### Key Blanks (50 Piece Minimum Order)

PDQ KEYWAY	COMPATIBLE WITH	LIST PRICE	
		5-PIN	6-PIN
ARA	Arrow / AR1	\$4.00	
CO59A1	Corbin 59A1		
CO6	Corbin / 60		
CL4	Corbin / L4		
RUD	Russwin / D1		
SCC	Schlage / C		
SCE	Schlage / E		
SAL	Sargent / LA		
SAS	Sargent / SAS		
RA-RC	Sargent / RA-RC		
YA8	Yale / E11		
GA	Yale / GA		
FAL	Falcon / E-R		
KW	Kwikset / KW		
<b>TA</b>	<b>PDQ / TA (Restricted. Limited to Grandmaster systems w/4 sub masters)</b>		
Large Bow Key	SCC		
Large Bow Key	SCE		
<b>INTERCHANGEABLE CORE KEY BLANKS</b>			<b>PRICE EACH</b>
Best Keyways: A, B, C, D, E, F, G, H, J, K, L, M, Q, WA, WB, WC, WD, WG, WH, TB, TD, TE, R, DD			\$5.00
IC Keyblank Stamped "U.S. Govt". Min order qty: 50ea			\$6.00

#### NOTES:

- Specify finish when ordering miscellaneous parts
- Kwikset cylinder available in 5 pin only



6 Pin Key Blank / 5 Pin Key Blank



Collars

IC Key blanks are stamped DND prohibiting duplication as standard. Unmarked blanks are available upon request.

### Miscellaneous Parts

DESCRIPTION	PDQ NO.	LIST PRICE
1-1/4" x 4-7/8" ANSI Dust Box (Specified with Lock)	Y025-SBX	\$8.00
1-1/4" x 4-7/8" ANSI Dust Box	Y025-SBX	
T-Strike Dust Box (Specified with Lock)	I0251	
T-Strike Dust Box	I0251	
FL-Strike Dust Box (Specified with Lock)	I0251R	
FL-Strike Dust Box	I0251R	
1-1/8" x 2-3/4" Deadbolt Dust Box	I4701	
IC Tailpiece assembly includes tailpiece and spacer	VP92905	\$12.00
GP Screw pack (any finish) / GT Screw pack (any finish)	V91910 / VA10030	\$8.00
1-1/8" Latch Front Filler Plate (Minimum of 100 pieces)	I099-100	\$2.00
<b>COLLARS AND BLOCKING RINGS</b>		
Rim Cylinder Ring	I5502	\$4.00
Mortise Cylinder Ring Step 5/32"	I5501	
Blocking Ring 1/8"	I55121	
Blocking Ring 5/32"	I034	
Blocking Ring 1/4"	I55012	\$17.00
Vandal Collar 11/16"	I5504	
Vandal Collar 13/16"	I5503	

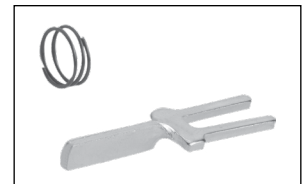

SFIC Tailpieces

\*Works with both GP and GT, SX and SD latches. (Grade 1 latches requires removal of breakaway center)

## Security. Performance. Flexibility.

Exit devices are a critical part of a building's fire and life safety egress system. PDQ manufactures a full line of exit devices, including rim, vertical rod and mortise for both wide and narrow stile doors. These devices provide the best combination of simplicity, strength, durability, aesthetics, and innovation and are perfect for a vast array of applications.

### Comprehensive Offering

---

**6300**  
Architectural Wide Stile



#### Applications

The all NEW 6300 Series Wide Stile Exit Devices incorporate modern push bar styling for heavy traffic applications. These Grade 1 certified devices are put to the ultimate test everyday in K-12, higher education, Healthcare, and government buildings. Other applications include offices, banks, assisted living facilities, retail stores, and other commercial buildings that have constant traffic.

---

**6400**  
Architectural Narrow Stile



#### Applications

The all NEW 6400 Series Wide Stile Exit Devices incorporate modern push bar styling for heavy traffic applications. These Grade 1 certified devices are put to the ultimate test everyday in K-12, higher education, Healthcare, and government buildings. Other applications include offices, banks, assisted living facilities, retail stores, and other commercial buildings that have constant traffic.

---

**4200**  
Commercial Wide Stile



#### Applications

When low cost and dependability are essential, the 4200 Series is a great choice. A reliable workhorse, the 4200 Series is an economical answer for stock doors and frames.

---

**9300**  
Mullions

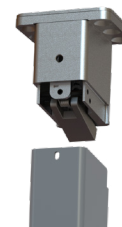

#### Applications

Designed for quick removal, the 9300 mullion is ideal in situations where carts, gurneys and large machinery need to pass freely through an opening. Popular applications include Healthcare, industrial manufacturing, and commercial businesses.



# 6300/6400 SERIES

## Architectural Exit Device

### Highlights

Chassis support is cast for high strength.

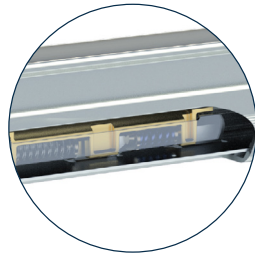
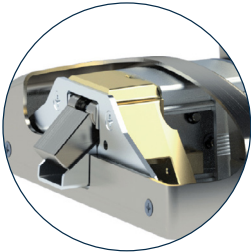

Push bar has angled ends and is nearly flush when dogged.

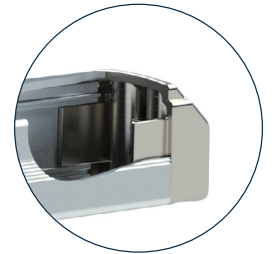
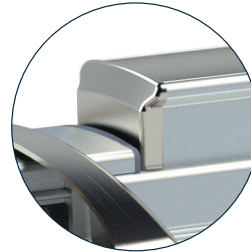

Flush end cap is standard, heavy duty engineered casting keys into the rail for ultimate pry resistance.



Cush spring quiets device in both directions. Compression spring returns the touch bar providing more reliability than a torsion type spring.

### Features

- Rugged, reliable, flexible, and simple design
- Designed & Assembled in Lancaster, PA
- Patent Pending
- Quiet operation - large heavy-duty spring cushion quiets both the compression/extension of the push bar
- Internal compression spring ensures long lasting push bar return
- Engineered strong and overbuilt for the most demanding environments
- Durable, heavy-duty flush end cap is standard and resist prying
- Stands up to cart abuse, heavy-duty flush end cap and tapered push bar designed to deflect hits and minimize damage
- Simple field door prep and installation
- Dogging holds bar in a retracted position nearly flush with head cover and rail
- Hex Key provided to dog/release the device
- No exposed screws on back of bar
- True 2-3/4" backset (with 5/8" frame stop and 1/8" door gap)
- Wood and machine screws included with each device
- Devices and trim are non-handed
- Ten (10) year warranty



**Rim**  
6300R / 6400R



**Surface Vertical Rod**  
6300V / 6400V



**Concealed Vertical Rod**  
6300C / 6400C



**Mortise**  
6300M

# 6300/6400R SERIES

## Wide/Narrow Stile Rim Exit Device



ASSEMBLED  
IN THE USA

### 6300R Wide Stile/6400R Narrow Stile Panic & Fire Rated



#### Specifications



<b>Rail</b>	• Extruded aluminum
<b>Latch</b>	• Stainless steel dead locking with 3/4" throw
<b>Hand</b>	• Device is non-handed • Trim is non-handed or field reversible
<b>Dogging</b>	• Hex key dogging standard • Cylinder dogging optional • Dogging not available for fire labeled devices
<b>Minimum Stile Width</b>	• 6300 - 3-1/2" • 6400 - 3 1/8" with 639027/639057 strike and 2 1/8" on aluminum frames with blade stop strike.
<b>Door Thickness</b>	• 1-3/4" - 2" (Consult factory for other)
<b>Door Width</b>	• 24", 36", 48" standard
<b>Door Height</b>	• Panic - Up to 10' • Fire - See fire ratings charts page 148
<b>Strike Options</b>	• Roller (Default) • Blade stop • Double door • Windstorm/Fire Mullion - Panic Mullion uses standard roller strike
<b>Finishes</b>	• 605 - Polished Brass, 606 - Satin Brass, 613E - Dark Oxidized Satin Bronze (Equivalent), 622 - Flat Black, 626 - Satin Chrome, 630 - Satin Stainless Steel, 630F - Full Stainless Steel • Optional Anti Microbial Coating available on 626, 630
<b>Fasteners</b>	• Includes machine and wood screws • SNB Optional
<b>Warranty</b>	• Ten (10) year limited warranty
<b>Electrified Options</b>	• Motorized Latch Retraction • Request to Exit/Signal Switch • Alarmed Exit • Latch Bolt Monitor • ISMC Connectors • Delayed Egress
<b>Certifications: Compliances: Listings:</b>	• Listed for UL 305 "Panic", listed for UL 10C "Fire Exit Hardware" up to 3 hours. • Certified to ANSI/BHMA A156.3 Grade 1 • FL #40297 +60/-65 psf 4080 16ga Single • FL #40297 +50/-50 psf 4080 18ga Single • Complies with ADA (Americans with Disabilities Act) and ICC/ANSI 117.1 for Accessible and Usable Buildings • Meets requirements of the BAA as a COTS product manufactured in the United States • Meets CBC Chapter 11B-309.4 when ordered with 5P option

# 6300/6400 RIM EXIT DEVICE

**LIST PRICE**  
Effective July 3, 2023

6300/6400  
RIM EXIT DEVICE

## How to Order

Series	For Door Width	Device Type	Rating	Finish	Options	Electrified Options
<b>63</b>	<b>00</b>	<b>R</b>	<b>--</b>	<b>630</b>	<b>--</b>	<b>--</b>
<b>63</b> - Wide Stile Device <b>64</b> - Narrow Stile Device	<b>00</b> - 36" Door <b>10</b> - 48" Door <b>20</b> - 24" Door	<b>R</b> - Rim Device	<b>Blank</b> - Panic Rated <b>F</b> - Fire Rated	<b>605</b> – Bright Brass <b>606</b> – Satin Brass <b>613E</b> – Dark Oxidized Satin Bronze (Equivalent) <b>622</b> – Satin Black <b>625</b> – Bright Chrome <b>626</b> – Satin Chrome <b>630</b> – Satin Stainless <b>630F</b> – Full Stainless	<b>Dogging</b> (Panic Rated Only): <b>Blank</b> - Hex Key Dogging <b>CD</b> - Cylinder Dogging <b>LD</b> - Less Dogging*  <b>Strikes:</b> <b>BS</b> - Blade Stop Strike (Rim) <b>DD</b> - Double Door Strike (Rim) <b>DE</b> - Delayed Egress  <b>WS</b> – Windstorm Rated (Rim & SVR) <b>EC</b> - End Cap Cover <b>TLA</b> - Head Cover <b>SNB</b> - Sex Nuts & Bolts <b>AM</b> - Anti-Microbial <b>SK</b> - Shim Kit <b>SHS</b> - Security Head Screws <b>5P</b> - Accessibility Device (5 lb maximum push force)	<b>MLR</b> - Motorized Latch Retr. <b>AL</b> - Alarm Kit* <b>SS</b> - Signal Switch on touch bar <b>LM</b> - Latchbolt Monitor <b>ISMC</b> - Industry Standard Molex Connector <b>ALHW</b> - Alarm kit hard wired <b>DE</b> - Delayed Egress

\*Multiple Selections Allowed  
 \*Dogging options only apply to Panic Rated  
 \*MLR can be combined with LM & SS  
 \*AL can be combined with LM  
 \*MLR and AL cannot be combined  
 \*ISMC available on all  
 \*AL - specify handing

## 6300R Rim Wide Stile Exit Devices

PART	DESCRIPTION	630	613E/622/626	605/606/625	630F
6300R	Rim, Listed to UL305 for Panic, hex key dogging, 3'0" door	\$900.00	\$943.00	\$1035.00	\$1075.00
6300RF	Rim, Listed to UL10C for Fire, no dogging 3'0" door	\$1062.00	\$1105.00	\$1197.00	\$1237.00
6310R	Rim, Listed to UL305 for Panic, hex key dogging, 4'0" door	\$946.00	\$989.00	\$1081.00	\$1121.00
6310RF	Rim, Listed to UL10C for Fire, no dogging 4'0" door	\$1108.00	\$1151.00	\$1243.00	\$1283.00
6320R	Rim, Listed to UL305 for Panic, no dogging, 2'0" door	\$1000.00	\$1043.00	\$1135.00	\$1175.00
6320RF	Rim, Listed to UL10C for Fire, no dogging 2'0" door	\$1162.00	\$1205.00	\$1297.00	\$1337.00

Available with all electrified options.

## 6400R Rim Narrow Stile Exit Devices

PART	DESCRIPTION	630	613E/622/626	605/606/625	630F
6400R	Rim, Listed to UL305 for Panic, hex key dogging, 3'0" door	\$983.00	\$1026.00	\$1118.00	\$1158
6400RF	Rim, Listed to UL10C for Fire, no dogging 3'0" door	\$1145.00	\$1188.00	\$1280.00	\$1320
6410R	Rim, Listed to UL305 for Panic, hex key dogging, 4'0" door	\$1029.00	\$1072.00	\$1164.00	\$1204
6410RF	Rim, Listed to UL10C for Fire, no dogging 4'0" door	\$1191.00	\$1234.00	\$1326.00	\$1366
6420R	Rim, Listed to UL305 for Panic, no dogging, 2'0" door	\$1083.00	\$1126.00	\$1218.00	\$1258
6420RF	Rim, Listed to UL10C for Fire, no dogging 2'0" door	\$1245.00	\$1288.00	\$1380.00	\$1420

# 6300/6400 RIM EXIT DEVICE

**LIST PRICE**

Effective July 3, 2023

## 6300/6400R Rim Mechanical Options

PART	DESCRIPTION	EXIT DEVICE ADJUSTMENT
EC	End Cap Cover	\$26.00
TLA	Head Cover (Similar to 6200 Series)	
AM	Anti Microbial (630/626 only)	\$98.00
WS	Florida HVHZ	\$66.00
CD	Cylinder Dogging	\$76.00
LD	Less Dogging	-
SNB	Sex Nuts & Bolts	\$26.00
BS	Blade Stop Strike	\$63.00
DD	Double Door Strike	
SHS	Tamper Proof Security Head Screws	\$54.00
5P	Accessibility Device (5 lb maximum push force)	\$85

## 6300/6400R Rim Electrified Options

PART	DESCRIPTION	EXIT DEVICE ADJUSTMENT
AL	Alarmed Exit	\$415.00
LM	Latch Bolt Monitoring	\$286.00
MLR	Motorized Latch Retraction	\$1030.00
SS	Signal Switch - Request to Exit or touch bar Monitoring	\$215.00
ALHW	Alarmed Exit with Hard Wire Power and Relay	\$580.00
ISMC	Industry Standard Molex Connector (order in addition to other electrified options)	\$108.00
DE	Delayed Egress	\$1900.00

1: Electrified options not available on 24" device.

2: For the MLR Motorized Latch Retraction option: 3 ft devices, maximum cut is 3". 4 ft devices, maximum cut is 9".

3: For the Alarm option: 3 ft devices, maximum cut is 2". 4 ft devices, maximum cut is 8".

# 6300/6400V SERIES

# Wide/Narrow Stile Surface Vertical Rod Exit Device



ASSEMBLED  
IN THE USA

## 6300V Wide Stile/6400V Narrow Stile Panic & Fire Rated



### Specifications

<b>Rail</b>	• Extruded aluminum
<b>Latch</b>	• Top - Stainless Steel 3/4" toggle • Bottom - 5/8" Travel Drop Bolt • Less bottom rod option
<b>Hand</b>	• Device is non-handed • Trim is non-handed or field reversible
<b>Dogging</b>	• Hex key dogging standard • Cylinder dogging optional • Dogging not available for fire labeled devices
<b>Minimum Stile Width</b>	• 6300 - 3-1/2" • 6400 - 3 1/8" with 639027/639057 strike and 2 1/8" on aluminum frames with balde stop strike.
<b>Door Thickness</b>	• 1-3/4" - 2" (Consult factory for other)
<b>Door Width</b>	• 24", 36", 48" standard
<b>Door Height</b>	• Panic - Up to 10' • Fire - See fire ratings charts page 148
<b>Strike</b>	• Cast top strike, plate bottom strike
<b>Finishes</b>	• 605 - Polished Brass, 606 - Satin Brass, 613E - Dark Oxidized Satin Bronze (Equivalent), 622 - Flat Black, 626 - Satin Chrome, 630 - Satin Stainless Steel, 630F - Full Stainless Steel • Optional Anti-Microbial Coating available on 626, 630
<b>Fasteners</b>	• Includes machine screws and wood screws • SNB Optional
<b>Warranty</b>	• Ten (10) year limited warranty
<b>Electrified Options</b>	• Motorized Latch Retraction • Request to Exit/Signal Switch • Alarmed Exit • Latch Bolt Monitor • ISMC Connectors • Delayed Egress (Can only be used on a door with a 3 1/2" or larger stile)
<b>Certifications: Compliances: Listings:</b>	• Listed for UL 305 "Panic", listed for UL 10C "Fire Exit Hardware" up to 3 hours. • ANSI/BHMA A156.3 Grade 1 • Complies with ADA (Americans with Disabilities Act) and ICC/ANSI 117.1 for Accessible and Usable Buildings • FL #40297 +50/-50 psf 8080 18ga Pair • Meets requirements of the BAA as a COTS product manufactured in the United States • Meets CBC Chapter 11B-309.4 when ordered with 5P option (Available with Top & Bottom Rod and Less Bottom Rod (LBR))

# 6300/6400 SURFACE VERTICAL ROD EXIT DEVICE

# LIST PRICE

Effective July 3, 2023

## How to Order

Series	For Door Width	Device Type	Rating	Finish	Options	Electrified Options
<b>63</b>	<b>00</b>	<b>V</b>	<b>--</b>	<b>630</b>	<b>--</b>	<b>--</b>
<b>63</b> - Wide Stile Device <b>64</b> - Narrow Stile Device	<b>00</b> - 36" Door <b>10</b> - 48" Door <b>20</b> - 24" Door	<b>V</b> - SVR Device	<b>Blank</b> - Panic Rated <b>F</b> - Fire Rated	<b>605</b> – Bright Brass <b>606</b> – Satin Brass <b>613E</b> – Dark Oxidized Satin Bronze (Equivalent) <b>622</b> – Satin Black <b>625</b> – Bright Chrome <b>626</b> – Satin Chrome <b>630</b> – Satin Stainless <b>630F</b> – Full Stainless	<b>Dogging</b> (Panic Rated Only): <b>Blank</b> - Hex Key Dogging <b>CD</b> - Cylinder Dogging <b>LD</b> - Less Dogging*  <b>LBR</b> - Less Bottom Rod (SVR/CVR) <b>LBR-FP</b> - Less Bottom Rod with Fire Pin (SVR/CVR)  <b>WS</b> – Windstorm Rated (Rim & SVR) <b>EC</b> - End Cap Cover <b>TLA</b> - Head Cover <b>SNB</b> - Sex Nuts & Bolts <b>AM</b> - Anti-Microbial <b>SK</b> - Shim Kit <b>SHS</b> - Security Head Screws <b>5P</b> - Accessibility Device (5 lb maximum push force)  <b>7</b> - 7' door (default) <b>8</b> - 8' door <b>10</b> - 8'-10' Door	<b>MLR</b> - Motorized Latch Retr. <b>AL</b> - Alarm Kit* <b>SS</b> - Signal Switch on touch bar <b>LM</b> - Latchbolt Monitor <b>ISMC</b> - Industry Standard Molex Connector <b>ALHW</b> - Alarm kit hard wired <b>DE</b> - Delayed Egress (Can only be used on a door with a 3 1/2" or larger stile)

\*Multiple Selections Allowed  
 \*Dogging options only apply to Panic Rated

## 6300V Surface Vertical Rod Wide Stile Exit Devices

PART	DESCRIPTION	630	613E/622/626	605/606/625	630F
6300V	Surface vertical rod, Listed to UL305 for Panic, hex key dogging, 3'0" door	\$1357.00	\$1400.00	\$1492.00	\$1532.00
6300VLBR	Surface vertical rod, less bottom rod, Listed to UL305 for Panic, hex key dogging, 3'0" door				
6300VF	Surface vertical rod, Listed to UL10C for Fire, no dogging, 3'0" door	\$1519.00	\$1562.00	\$1654.00	\$1694.00
6300VFLBR*	Surface vertical rod, less bottom rod, Listed to UL10C for Fire, no dogging, 3'0" door				
6310V	Surface vertical rod, Listed to UL305 for Panic, hex key dogging, 4'0" door	\$1403.00	\$1446.00	\$1538.00	\$1578.00
6310VLBR	Surface vertical rod, less bottom rod, Listed to UL305 for Panic, hex key dogging, 4'0" door				
6310VF	Surface vertical rod, Listed to UL10C for Fire, no dogging, 4'0" door	\$1565.00	\$1608.00	\$1700.00	\$1740.00
6310VFLBR*	Surface vertical rod, less bottom rod, Listed to UL10C for Fire, no dogging, 4'0" door				
6320V	Surface vertical rod, Listed to UL305 for Panic, no dogging, 2'0" door	\$1457.00	\$1500.00	\$1592.00	\$1632.00
6320VLBR	Surface vertical rod, less bottom rod, Listed to UL305 for Panic, no dogging, 2'0" door				
6320VF	Surface vertical rod, Listed to UL10C for Fire, no dogging, 2'0" door	\$1619.00	\$1662.00	\$1754.00	\$1794.00
6320VFLBR*	Surface vertical rod, less bottom rod, Listed to UL10C for Fire, no dogging, 2'0" door				

For devices over 7' high, add \$25 per foot

\*LBR FIRE RATED DEVICES MUST BE ORDERED IN PAIRS. One fire pin furnished per pair.



# 6300/6400 SURFACE VERTICAL ROD EXIT DEVICE

**LIST PRICE**

Effective July 3, 2023

## 6400V Surface Vertical Rod Narrow Stile Exit Devices

PART	DESCRIPTION	630	613E/622/626	605/606/625	630F
6400V	Surface vertical rod, Listed to UL305 for Panic, hex key dogging, 3'0" door	\$1439.00	\$1482.00	\$1574.00	\$1614.00
6400VLBR	Surface vertical rod, less bottom rod, Listed to UL305 for Panic, hex key dogging, 3'0" door				
6400VF	Surface vertical rod, Listed to UL10C for Fire, no dogging, 3'0" door	\$1601.00	\$1644.00	\$1736.00	\$1776.00
6400VFLBR*	Surface vertical rod, less bottom rod, Listed to UL10C for Fire, no dogging, 3'0" door				
6410V	Surface vertical rod, Listed to UL305 for Panic, hex key dogging, 4'0" door	\$1485.00	\$1528.00	\$1620.00	\$1660.00
6410VLBR	Surface vertical rod, less bottom rod, Listed to UL305 for Panic, hex key dogging, 4'0" door				
6410VF	Surface vertical rod, Listed to UL10C for Fire, no dogging, 4'0" door	\$1647.00	\$1690.00	\$1782.00	\$1822.00
6410VFLBR*	Surface vertical rod, less bottom rod, Listed to UL10C for Fire, no dogging, 4'0" door				
6420V	Surface vertical rod, Listed to UL305 for Panic, no dogging, 2'0" door	\$1539.00	\$1582.00	\$1674.00	\$1714.00
6420VLBR	Surface vertical rod, less bottom rod, Listed to UL305 for Panic, no dogging, 2'0" door				
6420VF	Surface vertical rod, Listed to UL10C for Fire, no dogging, 2'0" door	\$1701.00	\$1744.00	\$1836.00	\$1876.00
6420VFLBR*	Surface vertical rod, less bottom rod, Listed to UL10C for Fire, no dogging, 2'0" door				

For devices over 7' high, add \$25 per foot

**\*LBR FIRE RATED DEVICES MUST BE ORDERED IN PAIRS.** One fire pin furnished per pair.

**6300/6400**  
 SURFACE VERTICAL ROD  
 EXIT DEVICE

### 6300/6400V Surface Vertical Rod Mechanical Options

PART	DESCRIPTION	EXIT DEVICE ADJUSTMENT
EC	End Cap Cover	\$26.00
TLA	Head Cover (Similar to 6200 Series)	
AM	Anti Microbial (630/626 only)	\$98.00
CD	Cylinder Dogging	\$76.00
LD	Less Dogging	-
SNB	Sex Nuts & Bolts	\$26.00
SHS	Tamper Proof Security Head Screws	\$54.00
LBR	Less Bottom Rod	-
LBR-FP	Less Bottom Rod with Fire Pin (used with fire rated pair)	-
8', 9', 10'	Doors and Devices Over 7' Tall	ADD \$25.00 Per Foot
5P	Accessibility Device (5 lb maximum push force) (Available with Top & Bottom Rod and Less Bottom Rod (LBR))	\$85

### 6300/6400V Surface Vertical Rod Electrified Options

PART	DESCRIPTION	EXIT DEVICE ADJUSTMENT
AL	Alarmed Exit (Includes Latch Bolt Monitoring)	\$701.00
LM	Latch Bolt Monitoring	\$286.00
MLR	Motorized Latch Retraction	\$1030.00
SS	Signal Switch - Request to Exit and Monitoring	\$215.00
ALHW	Alarmed Exit with Hard Wire Power and Relay	\$580.00
ISMC	Industry Standard Molex Connector (order in addition to other electrified options)	\$108.00
DE	Delayed Egress (Can only be used on a door with a 3 1/2" or larger stile)	\$2500.00

1: Electrified options not available on 24" device.

2: For the MLR Motorized Latch Retraction option: 3 ft devices, maximum cut is 3". 4 ft devices, maximum cut is 9".

3: For the Alarm option: 3 ft devices, maximum cut is 2". 4 ft devices, maximum cut is 8".

# 6300/6400C SERIES

# Wide/Narrow Stile Concealed Vertical Rod Exit Device



ASSEMBLED  
IN THE USA

## 6300C Wide Stile/6400C Narrow Stile Panic & Fire Rated



### Specifications

<b>Rail</b>	• Extruded aluminum
<b>Latch</b>	• Top - Stainless Steel 3/4" toggle    • Bottom - 5/8" Travel Drop Bolt    • Less bottom rod option
<b>Hand</b>	• Device is non-handed    • Trim is non-handed or field reversible
<b>Dogging</b>	• Hex key dogging standard    • Cylinder dogging optional    • Dogging not available for fire labeled devices
<b>Minimum Stile Width</b>	• 6300 - 3-1/2"    • 6400 - 3 1/8" with 639027/639057 strike and 2 1/8" on aluminum frames with balde stop strike.
<b>Door Thickness</b>	• 1-3/4" - 2" (Consult factory for other)
<b>Door Width</b>	• 24", 36", 48" standard
<b>Door Height</b>	• Panic - Up to 10'    • Fire - See fire ratings charts page 148
<b>Strike</b>	• Cast top strike, plated bottom strike
<b>Finishes</b>	• 605 - Polished Brass, 606 - Satin Brass, 613E - Dark Oxidized Satin Bronze (Equivalent), 622 - Flat Black, 626 - Satin Chrome, 630 - Satin Stainless Steel, 630F - Full Stainless Steel • Optional Anti-Microbial Coating available on 626, 630
<b>Fasteners</b>	• Includes machine and wood screws    • SNB Optional
<b>Warranty</b>	• Ten (10) year limited warranty
<b>Electrified Options</b>	• Motorized Latch Retraction    • Request to Exit/Signal Switch    • Alarmed Exit • Latch Bolt Monitor    • ISMC Connectors    • Delayed Egress
<b>Certifications: Compliances: Listings:</b>	• Listed for UL 305 "Panic", listed for UL 10C "Fire Exit Hardware" up to 3 hours. • Complies with ADA (Americans with Disabilities Act) and ICC/ANSI 117.1 for Accessible and Usable Buildings • Meets requirements of the BAA as a COTS product manufactured in the United States • Certified to ANSI/BHMA A156.3 Grade 1 • Meets CBC Chapter 11B-309.4 when ordered with 5P option (Available with Top & Bottom Rod and Less Bottom Rod (LBR))

# 6300/6400 CONCEALED VERTICAL ROD EXIT DEVICE — LIST PRICE

Effective July 3, 2023

## How to Order

Series	For Door Width	Device Type	Rating	Finish	Options	Electrified Options
<b>63</b>	<b>00</b>	<b>C</b>	<b>--</b>	<b>630</b>	<b>--</b>	<b>--</b>
<b>63</b> - Wide Stile Device <b>64</b> - Narrow Stile Device	<b>00</b> - 36" Door <b>10</b> - 48" Door <b>20</b> - 24" Door	<b>C</b> - CVR Device <b>CWD</b> - Wood Door	<b>Blank</b> - Panic Rated <b>F</b> - Fire Rated	<b>605</b> – Bright Brass <b>606</b> – Satin Brass <b>613E</b> – Dark Oxidized Satin Bronze (Equivalent) <b>622</b> – Satin Black <b>625</b> – Bright Chrome <b>626</b> – Satin Chrome <b>630</b> – Satin Stainless <b>630F</b> – Full Stainless	<b>Dogging</b> (Panic Rated Only); <b>Blank</b> - Hex Key Dogging <b>CD</b> - Cylinder Dogging <b>LD</b> - Less Dogging* <b>DE</b> - Delayed Egress  <b>LBR</b> - Less Bottom Rod (SVR/CVR) <b>LBR-FP</b> - Less Bottom Rod with Fire Pin (SVR/CVR) <b>EC</b> - End Cap Cover <b>TLA</b> - Head Cover <b>SNB</b> - Sex Nuts & Bolts <b>AM</b> - Anti-Microbial <b>5P</b> - Accessibility Device (5 lb maximum push force)  <b>7</b> - 7' door (default) <b>8</b> - 8' door <b>10</b> - 8'-10' Door	<b>MLR</b> - Motorized Latch Retr. <b>AL</b> - Alarm Kit* <b>SS</b> - Signal Switch on touch bar <b>LM</b> - Latchbolt Monitor <b>ISMC</b> - Industry Standard Molex Connector <b>DE</b> - Delayed Egress

\*Multiple Selections Allowed  
 \*Dogging options only apply to Panic Rated

## 6300C Concealed Vertical Rod Wide Stile Exit Devices

PART	DESCRIPTION	630	613E/622/626	605/606/625	630F
6300C	Concealed vertical rod, Listed to UL305 for Panic, hex key dogging, 3'0" door	\$1570.00	\$1613.00	\$1705.00	\$1745.00
6300CLBR	Concealed vertical rod, less bottom rod, Listed to UL305 for Panic, hex key dogging, 3'0" door				
6300CF	Concealed vertical rod, Listed to UL10C for Fire, no dogging, 3'0" door	\$1732.00	\$1775.00	\$1867.00	\$1907.00
6300CFLBR*	Concealed vertical rod, less bottom rod, Listed to UL10C for Fire, no dogging, 3'0" door				
6310C	Concealed vertical rod, Listed to UL305 for Panic, hex key dogging, 4'0" door	\$1616.00	\$1659.00	\$1751.00	\$1791.00
6310CLBR	Concealed vertical rod, less bottom rod, Listed to UL305 for Panic, hex key dogging, 4'0" door				
6310CF	Concealed vertical rod, Listed to UL10C for Fire, no dogging, 4'0" door	\$1778.00	\$1821.00	\$1913.00	\$1953.00
6310CFLBR*	Concealed vertical rod, less bottom rod, Listed to UL10C for Fire, no dogging, 4'0" door				
6320C	Concealed vertical rod, Listed to UL305 for Panic, no dogging, 2'0" door	\$1670.00	\$1713.00	\$1805.00	\$1845.00
6320CLBR	Concealed vertical rod, less bottom rod, Listed to UL305 for Panic, no dogging, 2'0" door				
6320CF	Concealed vertical rod, Listed to UL10C for Fire, no dogging, 2'0" door	\$1832.00	\$1875.00	\$1967.00	\$2007.00
6320CFLBR*	Concealed vertical rod, less bottom rod, Listed to UL10C for Fire, no dogging, 2'0" door				

For devices over 7' high, add \$25 per foot

**\*LBR FIRE RATED DEVICES MUST BE ORDERED IN PAIRS.** One fire pin furnished per pair.

# 6300/6400 CONCEALED VERTICAL ROD EXIT DEVICE LIST PRICE

Effective July 3, 2023

## 6400C Concealed Vertical Rod Narrow Stile Exit Devices

PART	DESCRIPTION	630	613E/622/626	605/606/625	630F
6400C	Concealed vertical rod, Listed to UL305 for Panic, hex key dogging, 3'0" door	\$1651.00	\$1694.00	\$1786.00	\$1826.00
6400CLBR	Concealed vertical rod, less bottom rod, Listed to UL305 for Panic, hex key dogging, 3'0" door				
6400CF	Concealed vertical rod, Listed to UL10C for Fire, no dogging, 3'0" door	\$1813.00	\$1856.00	\$1948.00	\$1988.00
6400CFLBR*	Concealed vertical rod, less bottom rod, Listed to UL10C for Fire, no dogging, 3'0" door				
6410C	Concealed vertical rod, Listed to UL305 for Panic, hex key dogging, 4'0" door	\$1697.00	\$1740.00	\$1832.00	\$1872.00
6410CLBR	Concealed vertical rod, less bottom rod, Listed to UL305 for Panic, hex key dogging, 4'0" door				
6410CF	Concealed vertical rod, Listed to UL10C for Fire, no dogging, 4'0" door	\$1859.00	\$1902.00	\$1994.00	\$2034.00
6410CFLBR*	Concealed vertical rod, less bottom rod, Listed to UL10C for Fire, no dogging, 4'0" door				
6420C	Concealed vertical rod, Listed to UL305 for Panic, no dogging, 2'0" door	\$1751.00	\$1794.00	\$1886.00	\$1926.00
6420CLBR	Concealed vertical rod, less bottom rod, Listed to UL305 for Panic, no dogging, 2'0" door				
6420CF	Concealed vertical rod, Listed to UL10C for Fire, no dogging, 2'0" door	\$1913.00	\$1956.00	\$2048.00	\$2088.00
6420CFLBR*	Concealed vertical rod, less bottom rod, Listed to UL10C for Fire, no dogging, 2'0" door				

For devices over 7' high, add \$25 per foot

**\*LBR FIRE RATED DEVICES MUST BE ORDERED IN PAIRS.** One fire pin furnished per pair.

**6300/6400**  
CONCEALED VERTICAL  
ROD EXIT DEVICE

# 6300/6400 CONCEALED VERTICAL ROD EXIT DEVICE — LIST PRICE

Effective July 3, 2023

## 6300/6400 CVR Mechanical Options

PART	DESCRIPTION	EXIT DEVICE ADJUSTMENT
EC	End Cap Cover	\$26.00
TLA	Head Cover (Similar to 6200 Series)	
AM	Anti Microbial (630/626 only)	\$98.00
CD	Cylinder Dogging	\$76.00
LD	Less Dogging	-
SNB	Sex Nuts & Bolts	\$26.00
SHS	Tamper Proof Security Head Screws	\$54.00
LBR	Less Bottom Rod	-
LBR-FP	Less Bottom Rod with Fire Pin (used with fire rated pair)	-
8', 9', 10'	Doors and Devices Over 7' Tall	ADD \$25.00 Per Foot
5P	Accessibility Device (5 lb maximum push force) (Available with Top & Bottom Rod and Less Bottom Rod (LBR))	\$85

## 6300/6400 CVR Electrified Options

PART	DESCRIPTION	EXIT DEVICE ADJUSTMENT
AL	Alarmed Exit	\$415.00
LM	Latch Bolt Monitoring	\$286.00
MLR	Motorized Latch Retraction	\$1030.00
SS	Signal Switch - Request to Exit and Monitoring	\$215.00
ALHW	Alarmed Exit with Hard Wire Power and Relay	\$580.00
ISMC	Industry Standard Molex Connector (order in addition to other electrified options)	\$108.00
DE	Delayed Egress	\$1900.00

- 1: Electrified options not available on 24" device.
- 2: For the MLR Motorized Latch Retraction option: 3 ft devices, maximum cut is 3". 4 ft devices, maximum cut is 9".
- 3: For the Alarm option: 3 ft devices, maximum cut is 2". 4 ft devices, maximum cut is 8".

# 6300M SERIES

# Mortise Exit Device



ASSEMBLED  
IN THE USA

## 6300M Wide Stile Panic & Fire Rated



TLA Head Cover

Optional head cover  
\*630 Finish only



### Specifications

<b>Rail</b>	• Extruded aluminum
<b>Latch</b>	• Stainless steel dead locking with 3/4" throw
<b>Hand</b>	• Field reversible
<b>Dogging</b>	• Hex key dogging standard • Cylinder dogging optional • Dogging not available for fire labeled devices
<b>Minimum Stile Width</b>	• 5"
<b>Door Thickness</b>	• 1-3/4" - 2" (Consult factory for other)
<b>Door Width</b>	• 24", 36", 48" standard
<b>Door Height</b>	• Panic - Up to 10' • Fire - See fire ratings charts page 148
<b>Strike Options</b>	• Default ASA (4-7/8")
<b>Finishes</b>	• 605 - Polished Brass, 606 - Satin Brass, 613E - Dark Oxidized Satin Bronze (Equivalent), 622 - Flat Black, 626 - Satin Chrome, 630 - Satin Stainless Steel, 630F - Full Stainless Steel • Optional Anti Microbial Coating available on 626, 630
<b>Fasteners</b>	• Includes machine screws and wood screws • SNB Optional
<b>Warranty</b>	• Ten (10) year limited warranty
<b>Electrified Options</b>	• Motorized Latch Retraction • Request to Exit/Signal Switch • Alarmed Exit • Latch Bolt Monitor • ISMC Connectors • Delayed Egress
<b>Certifications: Compliances: Listings:</b>	• Listed for UL 305 "Panic", listed for UL 10C "Fire Exit Hardware" up to 90 minutes. • Complies with ADA (Americans with Disabilities Act) and ICC/ANSI 117.1 for Accessible and Usable Buildings • Meets requirements of the BAA as a COTS product manufactured in the United States

# 6300 MORTISE EXIT DEVICE

**LIST PRICE**

Effective July 3, 2023

## How to Order

Series	For Door Width	Device Type	Rating	Finish	Options	Electrified Options
<b>63</b>	<b>00</b>	<b>M</b>	<b>--</b>	<b>630</b>	<b>--</b>	<b>--</b>
<b>63 - Wide Stile Device</b>	<b>00 - 36" Door 10 - 48" Door 20 - 24" Door</b>	<b>M - Wide Stile Mortise Device*</b>	<b>Blank - Panic Rated</b>	<b>605 - Bright Brass 606 - Satin Brass 613E - Dark Oxidized Satin Bronze (Equivalent) 622 - Satin Black 625 - Bright Chrome 626 - Satin Chrome 630 - Satin Stainless 630F - Full Stainless</b>	<b>Dogging (Panic Rated Only): Blank - Hex Key Dogging CD - Cylinder Dogging LD - Less Dogging* DE - Delayed Egress  EC - End Cap Cover TLA - Head Cover SNB - Sex Nuts &amp; Bolts AM - Anti-Microbial SHS - Security Head Screws</b>	<b>MLR - Motorized Latch Retr. AL - Alarm Kit* SS - Signal Switch on touch bar LM - Latchbolt Monitor ISMC - Industry Standard Molex Connector ALHW - Alarm kit hard wired DE - Delayed Egress</b>

\*Mortise in wide stile device only

\*Multiple Selections Allowed  
\*Dogging options only apply to Panic Rated

\* MLR can be combined with LM & SS  
\* AL can be combined with LM  
\* MLR and AL cannot be combined  
\* ISMC available on all  
\* AL - specify handing

## 6300M Mortise Wide Stile Exit Devices

PART	DESCRIPTION	630	613E/622/626	605/606/625	630F
6300M	Mortise wide stile exit, Listed to UL305 for Panic, hex key dogging, 3'0" door width	\$1510.00	\$1553.00	\$1645.00	\$1685.00
6300MF	Mortise wide stile exit, Listed to UL10C for Fire, 3'0" door width	\$1672.00	\$1715.00	\$1807.00	\$1847.00
6310M	Mortise wide stile exit, Listed to UL305 for Panic, hex key dogging, 4'0" door width	\$1556.00	\$1599.00	\$1691.00	\$1731.00
6310MF	Mortise wide stile exit, Listed to UL10C for Fire, 4'0" door width	\$1718.00	\$1761.00	\$1853.00	\$1893.00
6320M	Mortise wide stile exit, Listed to UL305 for Panic, no dogging, 2'0" door	\$1610.00	\$1653.00	\$1745.00	\$1785.00
6320MF	Mortise wide stile exit, Listed to UL10C for Fire, no dogging 2'0" door	\$1772.00	\$1815.00	\$1907.00	\$1947.00

6300

MORTISE EXIT DEVICE



# 6300 MORTISE EXIT DEVICE

**LIST PRICE**

Effective July 3, 2023

## 6300M Mortise Wide Stile Mechanical Options

PART	DESCRIPTION	EXIT DEVICE ADJUSTMENT
EC	End Cap Cover	\$26.00
TLA	Head Cover (Similar to 6200 Series)	
AM	Anti Microbial (630/626 only)	\$98.00
CD	Cylinder Dogging	\$76.00
LD	Less Dogging	-
SNB	Sex Nuts & Bolts	\$26.00
SHS	Tamper Proof Security Head Screws	\$54.00

## 6300M Mortise Wide Stile Electrified Options

PART	DESCRIPTION	EXIT DEVICE ADJUSTMENT
AL	Alarmed Exit	\$415.00
LM	Latch Bolt Monitoring	\$286.00
MLR	Motorized Latch Retraction	\$1030.00
SS	Signal Switch - Request to Exit and Monitoring	\$215.00
ALHW	Alarmed Exit with Hard Wire Power and Relay	\$580.00
ISMC	Industry Standard Molex Connector (order in addition to other electrified options)	\$108.00
DE	Delayed Egress	\$1900.00

1: Electrified options not available on 24" device.

2: For the MLR Motorized Latch Retraction option: 3 ft devices, maximum cut is 3". 4 ft devices, maximum cut is 9".

3: For the Alarm option: 3 ft devices, maximum cut is 2". 4 ft devices, maximum cut is 8".

6300  
MORTISE EXIT DEVICE

# 6300D SERIES

# Dummy Exit Device



ASSEMBLED  
IN THE USA

## 6300D Dummy

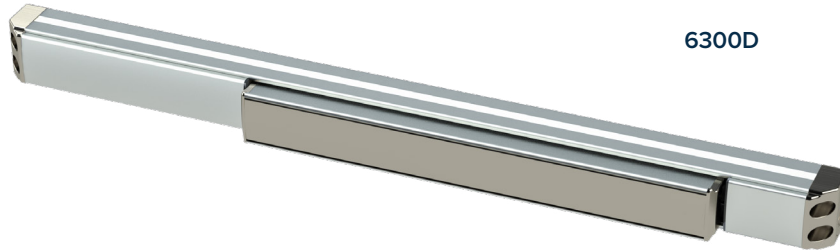

6300D



### Specifications

<b>Rail</b>	• Extruded aluminum
<b>Hand</b>	• Device is non-handed
<b>Dogging</b>	• Dogging standard    • Active push bar, dog to make inactive
<b>Minimum Stile Width</b>	• 3"
<b>Door Thickness</b>	• 1-3/4" - 2" (Consult factory for other)
<b>Door Width</b>	• 24", 36", 48" standard
<b>Finishes</b>	• 605 - Polished Brass, 606 - Satin Brass, 613E - Dark Oxidized Satin Bronze (Equivalent), 622 - Flat Black, 626 - Satin Chrome, 630 - Satin Stainless Steel, 630F - Full Stainless Steel • Optional Anti Microbial Coating available on 626, 630
<b>Fasteners</b>	• Includes machine and wood screws    • SNB Optional
<b>Warranty</b>	• Ten (10) year limited warranty
<b>Electrified Options</b>	• Request to Exit/Signal Switch    • ISMC Connectors
<b>Certifications: Compliances: Listings:</b>	• Complies with ADA (Americans with Disabilities Act) and ICC/ANSI 117.1 for Accessible and Usable Buildings • Meets requirements of the BAA as a COTS product manufactured in the United States

# 6300 DUMMY EXIT DEVICE

**LIST PRICE**  
Effective July 3, 2023

## How to Order

Series	For Door Width	Device Type	Finish	Options
<b>63</b>	<b>00</b>	<b>D</b>	<b>630</b>	<b>--</b>
<b>63</b> - Wide Stile Device	<b>00</b> - 36" Door <b>10</b> - 48" Door <b>20</b> - 24" Door	<b>D</b> - Dummy Device	<b>605</b> – Bright Brass <b>606</b> – Satin Brass <b>613E</b> – Dark Oxidized Satin Bronze (Equivalent) <b>622</b> – Satin Black <b>625</b> – Bright Chrome <b>626</b> – Satin Chrome <b>630</b> – Satin Stainless <b>630F</b> – Full Stainless	<b>Dogging</b> <b>SS</b> - Signal switch on touch bar

## 6300D Dummy Exit Devices

PART	DESCRIPTION	630	613E/622/626	605/606/625	630F
6300D	Dummy, 3'0" door	\$902.00	\$945.00	\$1037.00	\$1077.00
6310D	Dummy, 4'0" door	\$948.00	\$991.00	\$1083.00	\$1123.00
6320D	Dummy, 2'0" door	\$1002.00	\$1045.00	\$1137.00	\$1177.00

MORTISE EXIT DEVICE  
**6300**

## 6300D Dummy Mechanical Options

PART	DESCRIPTION	EXIT DEVICE ADJUSTMENT
EC	End Cap Cover	\$26.00
SNB	Sex Nuts & Bolts	
SHS	Tamper Proof Security Head Screws	\$54.00

## 6300D Dummy Electrified Options

PART	DESCRIPTION	EXIT DEVICE ADJUSTMENT
SS	Signal Switch - Request to Exit and Monitoring	\$215.00

## 6300RF / 6400RF Rim Devices

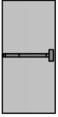
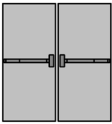
		RATING	MAX OPENING	APPLICATION
	Single Door	3 Hour Rated	4' x 10' Door	
	Double Door with 9300F Mullion	3 Hour Rated	8' x 8' Pair	Single Egress Pairs (Swing Same Direction)

## 6300VF / 6400VF Surface Vertical Devices

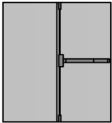
		RATING	MAX OPENING	APPLICATION
	Double Door Top/Btm Latches or Less Bottom Rod (LBR)	3 Hour Rated	8' x 10' Top/Btm Latches 8' x 8' Less Bottom Rod	Single Egress Pairs (Swing Same Direction)
	Double Door Top/Btm Latches or Less Bottom Rod (LBR)	3 Hour Rated	8' x 10' Top/Btm Latches 8' x 8' Less Bottom Rod	Double Egress Pairs (Swing Opposite Directions)

## 6300CF / 6400CF Concealed Vertical Devices

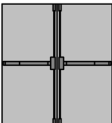
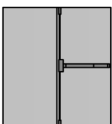
		RATING	MAX OPENING	APPLICATION
	Double Door Top/Btm Latches or Less Bottom Rod (LBR)	3 Hour Rated	8' x 8' Pair	Single Egress Pairs (Swing Same Direction)
	Double Door Top/Btm Latches or Less Bottom Rod (LBR)	3 Hour Rated	8' x 8' Pair	Double Egress Pairs (Swing Opposite Directions)

## 6300MF Mortise Devices

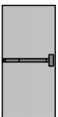
		RATING	MAX OPENING	APPLICATION
	Single Door	90 Minute Rated	4' x 8' Door	

# 6300/6400 DIMENSIONS

**LIST PRICE**

Effective July 3, 2023

## 6300 Series Wide Stile

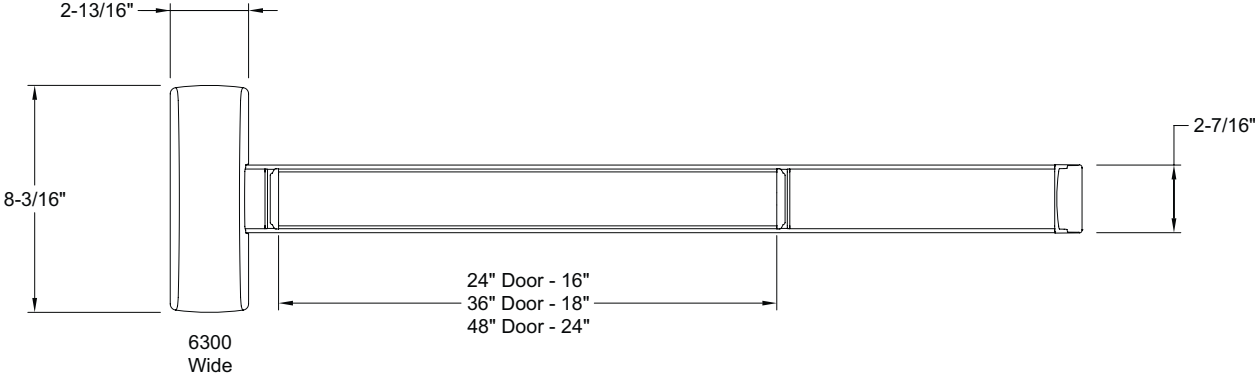

## 6400 Series Narrow Stile

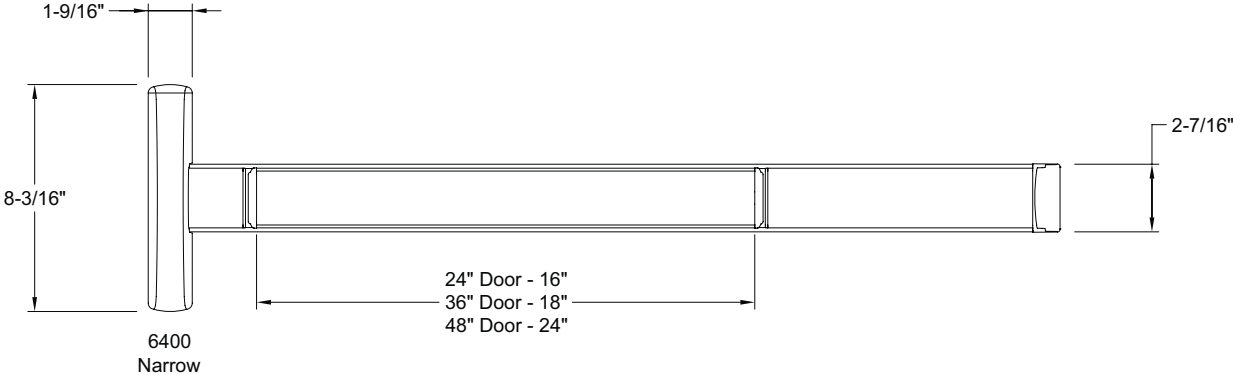

# 6300/6400 SERIES

## LIST PRICE

Effective July 3, 2023

### 6300/6400 Series Door Width Chart

PART	DESCRIPTION	FOR DOOR	MAX CUT <sup>1,2</sup>
6300R-CD	6300 Rim Cylinder dogging	36"	6"
6300R	6300 Rim Hex Key dogging	36"	6"
6300RF	6300 Rim Fire	36"	8"
6300V-CD	6300 SVR Cylinder dogging	36"	6"
6300V	6300 SVR Hex Key dogging	36"	6"
6300VF	6300 SVR Fire	36"	8"
6300C	6300 CVR Hex Key dogging	36"	6"
6300CF	6300 CVR Fire	36"	8"
6310R-CD	6300 Rim Cylinder dogging	48"	12"
6310R	6300 Rim Hex Key dogging	48"	12"
6310RF	6300 Rim Fire	48"	14"
6310V-CD	6300 SVR Cylinder dogging	48"	12"
6310V	6300 SVR Hex Key dogging	48"	12"
6310VF	6300 SVR Fire	48"	14"

24" DEVICE
No cut
No electric options

1: For the MLR Motorized Latch Retraction option: 3 ft devices, maximum cut is 3". 4 ft devices, maximum cut is 9".

2: For the Alarm option: 3 ft devices, maximum cut is 2". 4 ft devices, maximum cut is 8".

### 6300 Wide Stile Cross Reference

MANUFACTURER	EXIT DEVICE SERIES/TYPE							
	RIM	RIM FIRE	VERTICAL ROD	VERTICAL ROD FIRE	CONCEALED VERTICAL ROD	CONCEALED VERTICAL ROD FIRE	MORTISE	MORTISE FIRE
<b>PDQ</b>	<b>6300R</b>	<b>6300RF</b>	<b>6300V</b>	<b>6300VF</b>	<b>6300C</b>	<b>6300CF</b>	<b>6300M</b>	<b>6300MF</b>
CORBIN	ED5200	ED5200A	ED5400	ED5400A	ED5860	ED5860B	ED5600	ED5600A
DORMA	9300	F9300	9400	F9400	9100	F9100	9500	F9500
FALCON	25-R	F-25-R	25-V	F-25-V	25-C	F-25-C	25-M	F-25-M
HAGER	4501 RIM	4501 RIM FR	4501 SVR	4501 SVR FR	4500 CVR	4500 CVR FR	4500 MOR	4500 MOR FR
SARGENT®	8800	12-8800	8700	12-8700	8600	12-8600	8900	12-8900
VON DUPRIN	98/99	98/99-F	98/9927	98/9927-F	98/9947	98/9947-F	98/9975	98/9975-F
YALE	7100	7100F	7110	7110F	7160	7160F	7130	7130F

### 6400 Narrow Stile Cross Reference

MANUFACTURER	EXIT DEVICE SERIES/TYPE					
	RIM	RIM FIRE	VERTICAL ROD	VERTICAL ROD FIRE	CONCEALED VERTICAL ROD	CONCEALED VERTICAL ROD FIRE
<b>PDQ</b>	<b>6400R</b>	<b>6400RF</b>	<b>6400V</b>	<b>6400VF</b>	<b>6400C</b>	<b>6400CF</b>
CORBIN	ED4200	ED4200MA	ED4400	ED4400MA	ED4800	ED4800MA
DORMA	9700	F9700	9800	F9800	9600	F9600
FALCON	24-R	F-24-R	24-V	F-24-V	24-C	F-24-C
HAGER	4601 RIM	4601 RIM FR	4601 SVR	4601 SVR FR	4601 CVR	4601 CVR FR
SARGENT®	8500	12-8500	N/A	N/A	8400	12-8400
VON DUPRIN	33A/35A	33A/35A-F	3327A/3527A	3327A/3527A-F	3347A/3547A	3347A/3547A-F
YALE	7200	7200F	7210	7210F	7220	7220F

The following options are available when ordering 6300/6400 devices.

### LBR

Less Bottom Rod is available on SVR and CVR devices. This option deletes the bottom latch on applications where the bottom latch would impede access, or where a floor strike is not desired. LBR option is available on both panic and fire rated devices.

### EC

End Cap Cover option provides a cover for the standard end cap. Can be used if the look is preferred, or to cover the end of the rail on devices that have been cut down.

### TLA

The TLA head cover can be ordered to make the 6300 device better match the previous generation 6200 devices. The head cover is available in 630 finish only.

### SNB

Order the SNB option if Sex Nuts are required. These are used on devices when trim is not used, and door construction is not sufficient to hold screws (such as wood or composite core).

### SK

The Shim Kit is used to space the device out from the door. Shims are available in 1/8" and 1/4" thickness. Use multiple shims for additional clearance.

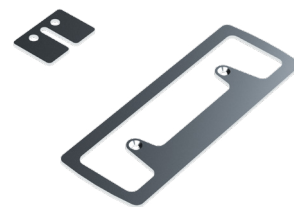

The following Rim Strike options are available when ordering 6300/6400 devices.

### BS – Blade Stop Strike (631041) – Rim Device

This strike is used on aluminum store front doors with a 1 / 2" blade stop. Strike comes with a protective plate to latch rubbing on frame and required mounting hardware.

*Strike is optional on both 6300 and 6400 devices.*

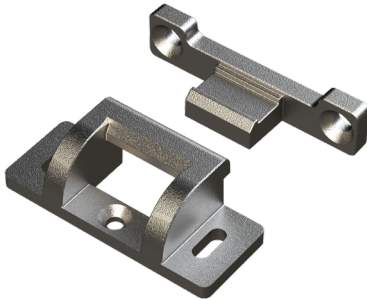

### ML – Mullion Fire Strike (639080) – Rim Device

This strike must be used for fire labeled rim devices when used with the 9300F mullion. It is also used for windstorm HVHZ labeled devices.

*(2) ML strikes are included with every fire rated mullion.*

### DD – Double Door Strike (639714) – Rim Device

This strike is used to mount a rim device on a pair of doors where one door is fixed by another means (e.g. Flush bolts, Surface bolts)

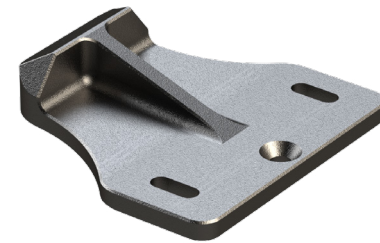

## Rim Device Stile Width Chart

Order Option	Strike #	Application	6300 Min Stile	6400 Min Stile
Default Panic	639027	Standard Panic Labeled	4-1/4"	3-1/8"
Default Fire	639057	Standard Fire Labeled	4-1/4"	3-1/8"
Default Panic	639027	Panic Labeled Mullion	4-3/4"	3-5/8"
ML	639080	Fire Labeled Mullion	4-7/8"	3-3/4"
WS	639080	Windstorm	4-3/8"	3-1/4"
DD	639714	Double Door Strike	4-1/4"	3-1/8"
BS	631041	Panic Labeled Blade Stop	3-1/2"	2-1/8"



# 6300/6400 SERIES PARTS

**LIST PRICE**

Effective July 3, 2023

## Parts

Panic Rated Head Chassis (for replacement only)	Specify		Price Each
	Wide Stile	Narrow Stile	
Rim	639001-R	649001-R	\$250.00
Vertical Rod	639001-V	649001-V	\$330.00
Concealed Vertical Rod	639001-C	649001-C	
Mortise	639001-M	-	
Mortise Lock Body	J163-finish	-	\$275.00

Fire Rated Head Chassis (for replacement only)	Specify		Price Each
	Wide Stile	Narrow Stile	
Rim	639001-RF	649001-RF	\$250.00
Vertical Rod	639001-V	649001-V	\$330.00
Concealed Vertical Rod	639001-C	649001-C	
Mortise	639001-M	-	
Mortise Lock Body	J163-finish	-	\$275.00

Latch Bolt Assembly *Does not include latchbolt cover	Specify	Price Each
Surface Vertical Rod Top Latchbolt	639154-xxx	\$175.00
Surface Vertical Rod Bottom Latchbolt	639156-xxx	\$175.00
Concealed Vertical Rod Top Latchbolt	639153	\$150.00
Concealed Vertical Rod Bottom Latchbolt	639155	\$150.00
Surface Vertical Rod Latchbolt mounting Bracket	631513	\$16.00
Concealed Vertical Rod Steel/Wood Door Latch Mounting Bracket	631511	
Less Bottom Rod Fire Bolt Kit	639720	\$170.00

Vertical Rod Parts	Specify	Price Each
Surface Vertical Rod Bottom Rod	631212SVRB-XXX*	\$55.00
Surface Vertical Rod Top Rod - 7' opening	631212SVRT-XXX*	
Surface Vertical Rod Top Rod - 8' opening	6312128SVR-XXX*	\$60.00
Surface Vertical Rod 3' Top Rod Extension	631212-36EXT-XXX*	\$55.00
Concealed Vertical Rod Bottom Rod	631212CVRB	
Concealed Vertical Rod Top Rod 7' opening	631212CVRT	
Concealed Vertical Rod Top Rod 8' opening	6312128CVR	\$60.00
Vertical Rod Connector	631205	\$28.00
Vertical Rod Extension Coupler	631206	
Concealed Vertical Rod End Link Assembly	639060	\$60.00

\*Specify finish



### Parts

Push Bar (specify finish)	Specify		Price Each
	3'	4'	
Device push bar	639703-36-XXX*	639703-48-XXX*	\$250.00
Push Bar faceplate	631030-18-XXX*	631030-24-XXX*	\$100.00

\*Specify finish

### Covers/Caps

Covers and Cap fasteners are listed separately

Standard Head/Chassis Cover (specify finish)	Specify		Price Each
	Wide Stile	Narrow Stile	
Rim	639704RW-XXX*	639704RN-XXX*	\$120.00
Vertical Rod	639704VW-XXX*	639704VN-XXX*	
Concealed Vertical Rod	639704BW-XXX*	639704BN-XXX*	
Mortise	639704BW-XXX*	-	
TLA Head/Chassis Cover	Specify		Price Each
	Wide Stile	Narrow Stile	
Rim	639705RW-630	639705RN-630	\$120.00
Vertical Rod	639705VW-630	639705VN-630	
Concealed Vertical Rod	639705BW-630	639705BN-630	
Mortise	639705BW-630	-	
SVR Latch Cover (specify finish)	Specify		Price Each
	Wide and Narrow Stile		
Latch cover for surface vertical rod top or bottom	631706-XXX		\$55.00
End Caps (specify finish) See fasteners section for screwpack	Specify		Price Each
	Wide and Narrow Stile		
End Cap	631032-XXX*		\$50.00
End Cap Cover	631109-XXX*		\$32.00
Miscellaneous	Specify		Price Each
	Wide and Narrow Stile		
SVR Rod Guide Assembly (sold with fastener)	639708-XXX*		\$40.00
Filler Plate Plastic End Cap	631034		\$5.00
Cover Bottom Plug for Surface Vertical LBR application	631222		

\*Specify finish

### Strikes & Shim's

Rim Strikes	Specify	Price Each
Rim Panic Strike	639709	\$35.00
Rim Fire Strike	639710	
Rim Blade Stop Strike	639711	\$110.00
Rim Mullion Fire / Windstorm Strike	639712	\$135.00
Rim Double Door Strike	639714	\$82.00
Rim Strike Shim's	Specify	Price Each
Rim Panic Strike Shim .100"	631126	\$14.00
Rim Fire Strike Shim .100"		
Rim Blade Stop Strike Shim .100"		
Rim Mullion Fire / Windstorm Strike Shim .100"	631619	\$32.00
Vertical Rod Strikes	Specify	Price Each
Surface & Concealed Vertical Rod Top Strike	639715	\$35.00
Surface & Concealed Vertical Rod Bottom Strike	639716	
Vertical Rod Strike Shim's	Specify	Price Each
Top Strike Shim 1/16"	631541	\$14.00
Mortise Exit Strikes	Specify	Price Each
Non Handed 6300M strike	631416	\$55.00

Device Shim Kits 1/8" Thickness	Specify		Price Each
	Wide Stile	Narrow Stile	
Rim	631125-830	631125-840	\$135.00
Surface Vertical Rod	631125-832	631125-842	
Concealed Vertical Rod	631125-830	631125-840	
Mortise	631125-820	-	
1/4" Thickness	Specify		Price Each
	Wide Stile	Narrow Stile	
Rim	631125-430	631125-440	\$165.00
Surface Vertical Rod	631125-432	631125-442	
Concealed Vertical Rod	631125-430	631125-430	
Mortise	631125-420	-	

### Parts

Drill Guides	Specify	Price Each
	Wide Stile	
Standard Roller Rim Strike Drill Guide	631127	\$25.00
Mullion Rim Fire / Windstorm Drill Guide	631620	

### Conversion Kits

Cylinder Dogging Conversion Kits (specify finish) *Cylinder and trim rings not included	Specify		Price Each
	Wide Stile	Narrow Stile	
3' Cylinder Dogging Conversion Kit	639701-3WC-XXX	639701-3NC-XXX	\$120.00
4' Cylinder Dogging Conversion Kit	639701-4WC-XXX	639701-4NC-XXX	
Collars for Cylinder Dogging (specify finish)	Specify		Price Each
	Wide Stile	Narrow Stile	
Tall Trim Ring / Spacer Reversible 5/8 Collar or 3/4" Spacer	631094-XXX	-	\$30.00
Short Trim Ring / Spacer Reversible No Height Collar or 1/4" Spacer	631093-XXX	-	\$18.00

Alarm Conversion Kits (specify finish) *Cylinder and trim rings not included	Specify		Price Each
	Wide Stile	Narrow Stile	
3' Panic Device	639702P-3WA-XXX	639702P-3NA-XXX	\$415.00
4' Panic Device	639702P-4WA-XXX	639702P-4NA-XXX	
3' Fire Device	639702F-3WA-XXX	639702F-3NA-XXX	
4' Fire Device	639702F-4WA-XXX	639702F-4NA-XXX	

### Cylinder Dogging Application Chart

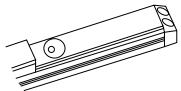
TRIM TYPE	FUNCTION	IMAGE	STANDARD CYLINDER	BEST SFIC	SCHLAGE STYLE LFIC
<b>CYLINDER DOGGING</b>	All Devices		1-1/8" Mortise Cylinder 631093 Trim Ring Yale Cam	SFIC 7 pin housing (2) 631093 Trim Rings Yale Cam	LFIC housing 631094 Collar (5/8") Yale Cam

### Parts

Replacement Dogging Parts	Specify	Price Each
Hex Dogging Mechanism	639022H	\$82.00
Cylinder Dogging Mechanism	639022C	
Cylinder anti-rotation plate (alarm kit & cyl dogging)	631095	\$10.00
Cylinder retaining nut (alarm kit, cylinder dogging, 6N, 6W)	88644	
Dogging Key - 3/16" with Loop	631113	\$14.00
Cylinder Nut Tool	88875	\$150.00

Screwpacks	Specify	Price Each
Device Screwpack	639043	\$16.00
Surface Vertical Rod Connector Screwpack	639044	
Surface Vertical Rod Latch Screwpack	639045	
Concealed Vertical Rod Latch Screwpack	639049	
Rim Strike Screwpack	639050	\$6.00
Vertical Rod Strike Screwpack (SVR/CVR)	639054	\$16.00
Sex Bolt (SNB) 4 Pack 626/630	639053-04	\$45.00
Sex Bolt (SNB) 4 Pack 622/613E	639053-H	
Sex Bolt (SNB) 4 Pack 605/606	639053-08	
Screwpack, Head Cover or SVR Latch Cover	639721	\$16.00
Screwpack, End Cap Cover	639722	

Electrification	Specify	Price Each
Signal Switch (for panic rated device)	639718	\$215.00
Signal Switch (for fire rated device)	639719	
Motorized Latch Retraction	639026	\$1255.00
Wire Routing Guide	639067	\$60.00
Latchbolt monitoring	contact factory	\$285.00

# 6300/6400 SERIES

# Wide Stile/Narrow Stile Exit Device Trims

Trims are non-handed and use simple door prep based on a 2 hole bolt pattern with 7" centers, or a 4 hole bolt pattern with 7"x1-3/8" centers.

Narrow escutcheons work with both wide and narrow stile devices. Wide escutcheons work only with wide stile devices.



**6N Narrow Escutcheon** - A narrow profile escutcheon for 6300 or 6400 device. Available in 6 lever styles, and in 6 functions. Use with narrow stile devices or a wide stile device when a slimmer look is desired.



**6W Wide Escutcheon** - A wide escutcheon for the 6300 device. Available in 6 lever styles, and 5 functions - including electric locking. Use with wide stile devices, when a more substantial look is desired, or for retrofit where covering existing holes is important.

*\*Not compatible with 6400 narrow stile devices*



**6T Thumb Latch** - A grip pull with a thumb latch for 6300 or 6400 devices. Available in 4 functions.

*\*Not compatible with 6400C narrow stile devices.*



**6P Pull Plate** - Stainless Steel pull plate for 6300 device.

*\*Not compatible with 6400 narrow stile devices.*



**6G Grip Pull** - A grip pull for 6300 or 6400 devices. Made of stainless steel, this grip pull is available in 2 functions.



**6S Rose Trim** - Rose trim that fits into standard 161 prepped door with thru bolts. Works with 6300 rim, SVR and CVR devices. Available in 3 lever styles and in 4 functions.

*\*Not compatible with 6400 narrow stile devices*



**6GW Grip Pull** - A wide grip pull designed for 6300 exit devices. Available in 3 finishes and 2 functions.

*\*Not compatible with 6400 devices*



**6C Cylinder only** - Order this trim option for cylinder only, NightLatch (F03) Function. Includes rim cylinder or \*IC rim housing, collar, and required mounting hardware.

*\*IC core sold separately*

## Lever Styles

PHL



BSN



MIA



ORL



CHI



LAX



# 6300/6400 SERIES TRIMS

**LIST PRICE**

Effective July 3, 2023

## How to Order

TRIM TYPE	LEVER	FINISH	OPTIONS	CYLINDER TYPE	KEYWAY	KEYING
<b>6N08</b>	<b>PHL</b>	<b>630</b>	<b>AM</b>	<b>D</b>	<b>SCC</b>	<b>KD</b>
<b>Narrow Escutcheon</b>	<b>PHL</b> – Philadelphia	<b>605</b> – Bright Brass	<b>AM</b> - Antimicrobial	<b>D</b> Default	<b>SCC</b> – Schlage C	<b>KD</b> – Keyed Different
<b>6N01/6NM01</b> – Narrow, Blank (No lever)	<b>BSN</b> – Boston	<b>606</b> – Satin Brass	<b>TC</b> - Tactile Abrasive Coating	<b>L</b> Less Cylinder	<b>OTHERS</b> – See Keyway Table	<b>KA</b> – Keyed Like
<b>6N02/6NM02</b> – Narrow, Fixed Lever	<b>MIA</b> – Miami	<b>613E</b> – Dark Oxidized Satin Bronze (Equivalent)	<b>TD4</b> - 2-1/2" - 2-3/4" thick application	<b>SF6</b> Lock is SFIC prepped w/ 6 pin core		<b>KO</b> – Zero Bitted
<b>6N03</b> – Narrow, Cylinder Only (No Lever) Night Latch	<b>*CHI</b> – Chicago	<b>622</b> – Satin Black	<b>TD5</b> - Up to 3" thick application	<b>SF7</b> Lock is SFIC prepped w/ 7 pin core		<b>MK</b> – Master Keyed
<b>6N08/6NM08</b> – Narrow, Classroom	<b>*ORL</b> – Orlando	<b>625</b> – Bright Chrome	<b>W</b> - Weatherized (Excludes 6C and Cylinders)	<b>SFL</b> Lock is SFIC prepped but less core		<b>CMK</b> – Construction Master Keyed
<b>6N09/6NM09</b> – Narrow Storeroom	<b>*LAX</b> – Los Angeles	<b>626</b> – Satin Chrome		<b>SFC</b> Lock is SFIC prepped w/ construction core		<b>GMK</b> – Grand Master Keyed
<b>6N14/6NM14</b> – Narrow Passage	<b>*Not available with S Trim</b>	<b>630</b> – Satin Stainless		<b>SFP</b> Lock is SFIC prepped w/ plastic construction core		
<b>Wide Escutcheon</b>				<b>LF6</b> Lock is Schlage LFIC prepped w/ Schlage core		
<b>6W02/6WM02</b> – Wide, Fixed Lever				<b>LFL</b> Lock is Schlage LFIC prepped but less core		
<b>6W08/6WM08</b> – Wide, Classroom				<b>LFC</b> Lock is Schlage LFIC prepped w/ construction core		
<b>6W09/6WM09</b> – Wide, Storeroom				<b>*Cores sold separately - option specifies factory installation</b>		
<b>6W14/6WM14</b> – Wide, Passage						
<b>6W99/6WM99</b> – Electrified						
<b>Sectional/Rose</b>						
<b>6S02</b> – Sectional, Rigid Lever						
<b>6S08</b> – Sectional, Classroom						
<b>6S09</b> – Sectional, Storeroom						
<b>6S14</b> – Sectional, Passage						
<b>Thumb Latch</b>						
<b>6T02</b> – Thumb Latch, Dummy, Rigid thumb piece						
<b>6T05</b> – Thumb Latch, Classroom						
<b>6T06</b> – Thumb Latch, Storeroom						
<b>6T15</b> – Thumb Latch, Passage						
<b>Pull Plate</b>						
<b>6P03</b> – Pull Plate, Cylinder						
<b>Grip Pull</b>						
<b>6G02/6GM02</b> – Pull only						
<b>6G03/6GM03</b> – Night Latch						
<b>Cylinder Only</b>						

6300/6400 EXIT DEVICE TRIMS



**6N**

Narrow Escutcheon  
01, 02, 03, 08, 09, 14



**6W**

Wide Escutcheon  
02, 08, 09, 14, 99



**6G**

Grip Pull  
02, 03



**6GW**

Wide Grip Pull  
02, 03, M03



**6T**

Thumb Latch  
02, 05, 06, 15



**6P**

Pull Plate  
02, 03



**6S**

Sectional/Rose  
02, 08, 09, 14



**6C**

Cylinder Only  
03

# 6300/6400 SERIES TRIMS

**LIST PRICE**

Effective July 3, 2023

## 6N Functions

### 01 Blank

Blank Escutcheon



### 02 Pull Only

Entrance/Pull only when device is dogged. Fixed lever.

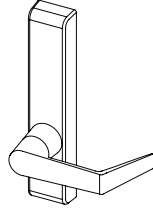

### 03 Night Latch

Entrance when latch retracted by key. Key removable only when locked.

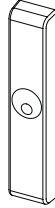

### 08 Classroom

Key locks or unlocks lever.

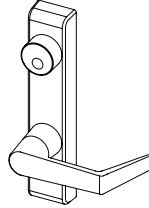

### 09 Storeroom

Entrance by lever when unlocked by key. Key removable only when locked.

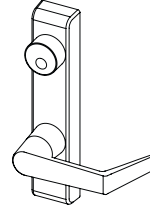

### 14 Passage

Entrance by lever, always unlocked.

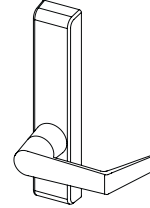

## 6N Lever Styles

### PHL

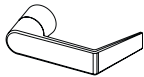

### BSN



### MIA

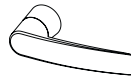

### ORL

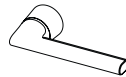

### CHI

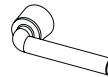

### LAX

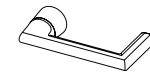

## Applicable Devices

- 6400R Narrow Rim Device
- 6400V Narrow Surface Vertical Device
- 6400C Narrow Concealed Vertical Device
- 6300R Wide Stile Rim Device
- 6300V Wide Surface Vertical Device
- 6300C Wide Concealed Vertical Device
- 6300M Wide Mortise Device (Except 03 function)

CYLINDER OPTIONS	ICON	LOCK ADJUSTMENT
SFL		N/C
LFL		
D		

IC Core not included.

## 6N Narrow Stile Trim

6N	APPLICATION	FUNCTION	DESCRIPTION	LEVER	630	605/606/ 613E/622/625/626
	Rim Surface Vertical Rod Concealed Vertical Rod	01	Blank (no lever)	PHL, BSN, MIA, ORL, CHI, LAX	\$109.00	\$125.00
		02	Dummy Trim (Rigid Lever)		\$384.00	\$400.00
		03	Night Latch (no lever)		\$171.00	\$187.00
		08	Classroom w/ Lever		\$446.00	\$462.00
		09	Storeroom w/ Lever			
		14	Passage w Lever		\$384.00	\$400.00



# 6300/6400 SERIES TRIMS

**LIST PRICE**

Effective July 3, 2023

## 6NM Narrow Stile Mortise Trim

6N	APPLICATION	FUNCTION	DESCRIPTION	LEVER	630	605/606/ 613E/622/625/626
<p>NARROW ESCUTCHEON</p> 	Mortise	M01	Blank (no lever)	PHL, BSN, MIA, ORL, CHI, LAX	\$109.00	\$125.00
		M02	Dummy Trim (Rigid Lever)		\$384.00	\$400.00
		M08	Classroom w/ Lever		\$446.00	\$462.00
		M09	Storeroom w/ Lever			
		M14	Passage w Lever		\$384.00	\$400.00

**6300/6400**  
EXIT DEVICE TRIMS

# 6300/6400 SERIES TRIMS

**LIST PRICE**  
Effective July 3, 2023

## 6W Functions

### 02 Pull Only

Entrance/Pull only when device is dogged. Fixed lever.

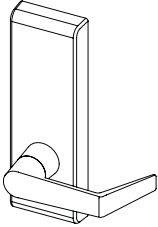

### 08 Classroom

Key locks or unlocks lever. Conversion kit included to convert locking function.

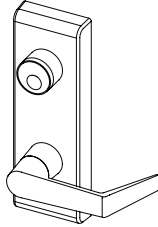

### 09 Storeroom

Entrance by lever when unlocked by key. Key removable only when locked.

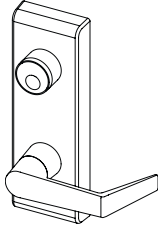

### 14 Passage

Entrance by lever, always unlocked.

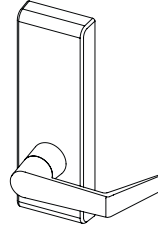

### 99 Electrified

Locked/Unlocked electronically. FS/FSF configurable. Entry by key. Key does not change lock state.

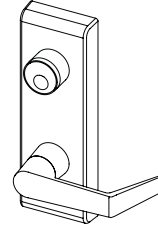

## 6W Lever Styles

### PHL

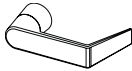

### BSN



### MIA

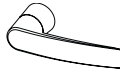

### ORL



### CHI

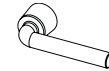

### LAX

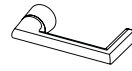

## Applicable Devices

- 6300R Wide Stile Rim Device
- 6300V Wide Surface Vertical Device
- 6300C Wide Concealed Vertical Device
- 6300M Wide Mortise Device

CYLINDER OPTIONS	ICON	LOCK ADJUSTMENT
SFL		N/C
LFL		
D		

IC Core not included.

## 6W Wide Stile Trim

6W	APPLICATION	FUNCTION	DESCRIPTION	LEVER	630	605/606/ 613E/622/625/626
	Rim Surface Vertical Rod Concealed Vertical Rod	02	Dummy Trim (Rigid Lever)	PHL, BSN, MIA, ORL, CHI, LAX	\$415.00	\$431.00
		08	Classroom w/ Lever		\$478.00	\$494.00
		09	Storeroom w/ Lever		\$415.00	\$431.00
		14	Passage w/ Lever		\$867.00	\$883.00
		99	Electrified Storeroom			

6W08 and 6W09 includes conversion kit from factory (6W08 to 6W09 or 6W09 to 6W08)

# 6300/6400 SERIES TRIMS

**LIST PRICE**

Effective July 3, 2023

## 6WM Wide Stile Mortise Trim

6W	APPLICATION	FUNCTION	DESCRIPTION	LEVER	630	605/606/ 613E/622/625/626
 <p>WIDE STILE</p>	Mortise	M02	Dummy Trim (Rigid Lever)	PHL, BSN, MIA, ORL, CHI, LAX	\$415.00	\$431.00
		M08	Classroom w/ Lever		\$478.00	\$494.00
		M09	Storeroom w/ Lever		\$415.00	\$431.00
		M14	Passage w/ Lever		\$867.00	\$883.00
		M99	Electrified Storeroom			

**6W08 and 6W09 includes conversion kit from factory (6W08 to 6W09 or 6W09 to 6W08)**

### 6T Functions

#### 02 Pull Only

Entrance/Pull only when device is dogged. Rigid Thumb piece.

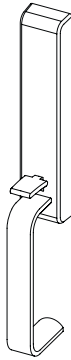

#### 05 Classroom

Key locks or unlocks thumb piece.

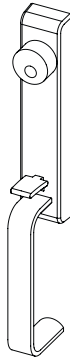

#### 06 Storeroom

Entrance by thumb piece when released by key. Key removable only when locked.

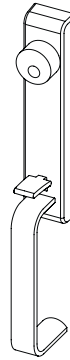

#### 15 Passage

Entrance by lever when unlocked by key. Key removable only when locked.

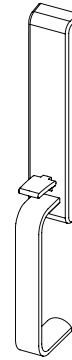

### Applicable Devices

- 6300R Wide Stile Rim Device
- 6300V Wide Surface Vertical Device
- 6300C Wide Stile Concealed Vertical Device
- 6400R Narrow Rim Device
- 6400V Narrow Surface Vertical Device
- 6400C Narrow Concealed Vertical Device

### 6T Thumb Latch Trim

6T	APPLICATION	FUNCTION	DESCRIPTION	630	613E/622	CYLINDER OPTIONS	ICON	LOCK ADJUSTMENT
THUMB LATCH 	Rim Surface Vertical Rod Concealed Vertical Rod	02	Dummy. Rigid thumb piece.	\$345.00	\$361.00	SFL		N/C
		05	Classroom	\$370.00	\$386.00	LFL		
		06	Storeroom			D		
		15	Passage	\$345.00	\$361.00			

IC Core not included.

### 6P Functions

#### 03 Night Latch

Entrance when latch retracted by key. Key removable only when locked.

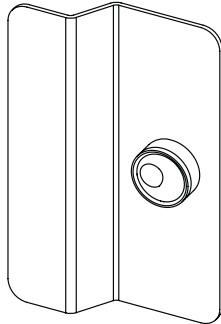



### Applicable Devices

- 6300R Wide Stile Rim Device
- 6300V Wide Surface Vertical Device
- 6300C Wide Concealed Vertical Device

### 6P Pull Trim

6P	APPLICATION	FUNCTION	DESCRIPTION	630	613E/622
<p>PULL TRIM</p> 	<p>Rim Surface Vertical Rod Concealed Vertical Rod</p>	03	Night Latch	\$158.00	\$174.00

CYLINDER OPTIONS	ICON	LOCK ADJUSTMENT
SFL		N/C
LFL		
D		

IC Core not included.

# 6300/6400 SERIES TRIMS

**LIST PRICE**

Effective July 3, 2023

## 6G/6GW Functions

### 02 Pull Only

Entrance/Pull only when device is dogged.

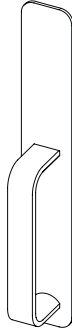

### 03 Night Latch

Entrance when latch retracted by key. Key removable only when locked.

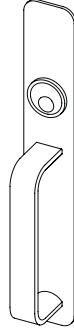

### M03 Mortise Night Latch

Entrance when latch retracted by key. Key removable only when locked.

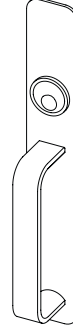

## Applicable Devices



- 6300R Wide Stile Rim Device
- 6300V Wide Surface Vertical Device
- 6300C Wide Concealed Vertical Device
- 6300M Wide Mortise Device
- 6400R Narrow Rim Device (6G Only)
- 6400V Narrow Surface Vertical Device (6G Only)
- 6400C Narrow Concealed Vertical Device (6G Only)

## 6G/6GW Grip Pull Trim

PULL	APPLICATION	FUNCTION	DESCRIPTION	630	613E/622	CYLINDER OPTIONS	ICON	LOCK ADJUSTMENT
6G GRIP PULL 	Rim	02	Dummy Trim (Grip Pull only)	\$166.00	\$182.00	SFL		N/C
	Surface Vertical Rod	03	Night Latch	\$220.00	\$236.00	LFL		
6GW GRIP PULL 	Rim	02	Dummy Trim (Grip Pull only)	\$176.00	\$192.00	D		
	Surface Vertical Rod	03	Night Latch	\$230.00	\$246.00			
	Concealed Vertical Rod							
	Concealed Vertical Rod							

IC Core not included.

## 6GM Grip Pull Mortise Trim

6G	APPLICATION	FUNCTION	DESCRIPTION	630	613E/622
6G GRIP PULL 	Mortise	M02	Dummy Trim (Grip Pull only)	\$166.00	\$182.00
		M03	Night Latch	\$220.00	\$236.00
6GW GRIP PULL 	Mortise	M02	Dummy Trim (Grip Pull only)	\$176.00	\$192.00
		M03	Night Latch	\$230.00	\$246.00

# 6300/6400 SERIES TRIMS

**LIST PRICE**

Effective July 3, 2023

## 6S Functions

### 02 Pull Only

Entrance/Pull only when device is dogged. Lever is fixed.

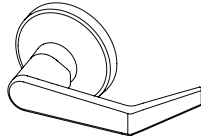

### 08 Classroom

Key locks or unlocks lever.

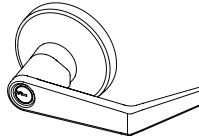

### 09 Storeroom

Entrance by lever when key inserted. Key removable only when locked.

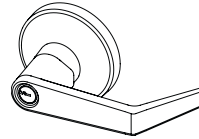

### 14 Passage

Entrance by lever. Always unlocked.

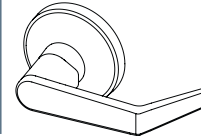

## 6S Lever Styles

PHL

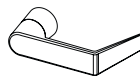

BSN



MIA

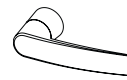



## Applicable Devices

- 6300R Wide Stile Rim Device
- 6300V Wide Surface Vertical Device
- 6300C Wide Concealed Vertical Device

## 6S Sectional Trim

6S	APPLICATION	FUNCTION	DESCRIPTION	LEVER	626	605/606 613E/622/ 630
SECTIONAL LEVER  	Rim Surface Vertical Rod Concealed Vertical Rod	02	Dummy Trim	BSN, MIA, PHL	\$220.00	\$236.00
		08	Classroom w/ Lever		\$277.00	\$293.00
		09	Storeroom w/ Lever			
		14	Passage w/ Lever		\$250.00	\$266.00

CYLINDER OPTIONS	ICON	LOCK ADJUSTMENT
SFL		N/C
LFL		
D		

IC Core not included.

Note: LFL Prep only available in PHL lever

Note: 6S Trim shipped after March 2022 is not compatible with 6200 series exit devices. Contact factory for retrofit trim.

6300/6400  
EXIT DEVICE TRIMS

# 6300/6400 SERIES TRIMS

**LIST PRICE**

Effective July 3, 2023

## 6C Cylinder Only



**6C Cylinder Only** - Order this trim option for cylinder only, Night Latch (F03) Function. Includes rim cylinder or \*IC rim housing, collar, and required mounting hardware.





\*IC core sold separately

## How to Order

Series	Function	Finish	Cylinder Type	Keying
<b>6C</b>	<b>03</b>	<b>630</b>	<b>D</b>	<b>SCC</b>
<b>6C</b> - Cylinder Only - 6300/6400 Device	<b>03</b> - Night Latch (Rim) <b>M03</b> - Night Latch (Mortise)	<b>605</b> – Bright Brass  <b>606</b> – Satin Brass  <b>613E</b> – Dark Oxidized Satin Bronze (Equivalent) <b>622</b> – Satin Black <b>625</b> – Bright Chrome <b>626</b> – Satin Chrome <b>630</b> - Stainless Steel	<b>D</b> Default  <b>L</b> Less Cylinder  <b>SF6</b> - SFIC prepped w/ 6 pin core <b>SF7</b> - SFIC prepped w/ 7 pin core <b>SFL</b> - SFIC prepped but less core <b>SFC</b> - SFIC prepped w/ construction core  <b>SFP</b> - SFIC prepped w/ plastic construction core <b>LF6</b> - Schlage LFIC prepped w/ Schlage core <b>LFL</b> - Schlage LFIC prepped but less core <b>LFC</b> - Schlage LFIC prepped w/ construction core	<b>SCC</b> – Schlage C  <b>Others</b> – See Keyway Table Page

6300/6400  
EXIT DEVICE TRIMS

## 6C Cylinder Only

6C	APPLICATION	FUNCTION	DESCRIPTION	605/606/613E/ 619/622/625 626/630	CYLINDER OPTIONS	ICON	LOCK ADJUSTMENT
CYLINDER ONLY 	Rim Surface Vertical Rod Concealed Vertical Rod	03	6C - Cylinder Only - 6300/6400 Device	\$133.00	SFL		N/C
					LFL		
					D		

## 6CM Cylinder Only

6C	APPLICATION	FUNCTION	DESCRIPTION	605/606/613E/ 622/625 626/630
CYLINDER ONLY 	Mortise	M03	6CM - Cylinder Only - 6300 Mortise Device	\$133.00

IC Core not included.



# 6300/6400 TRIM DIMENSIONS

**LIST PRICE**

Effective July 3, 2023

## Trim Dimensions

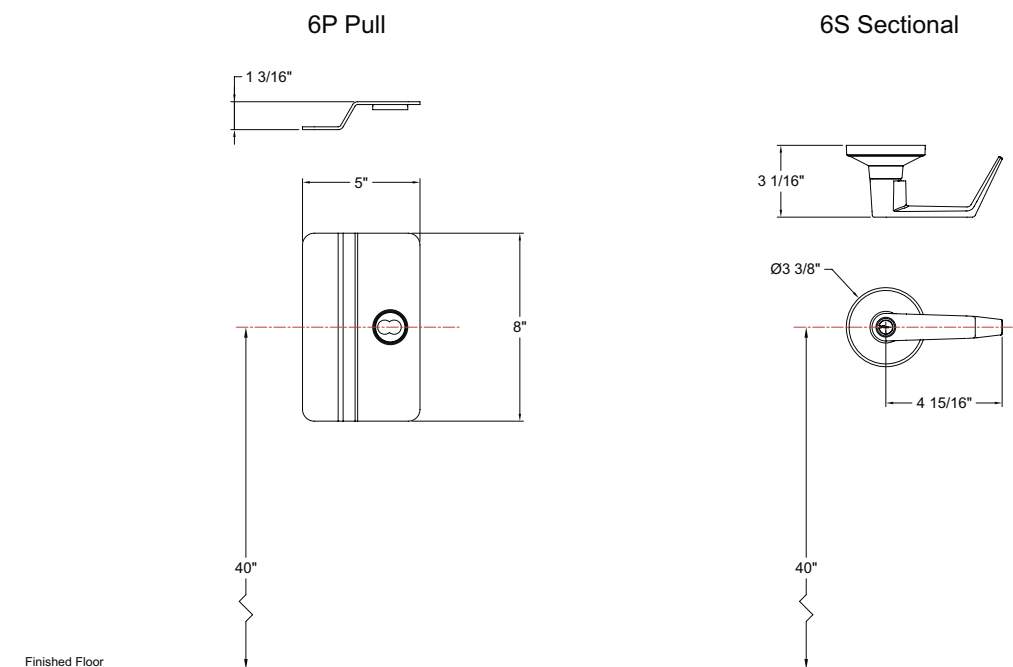
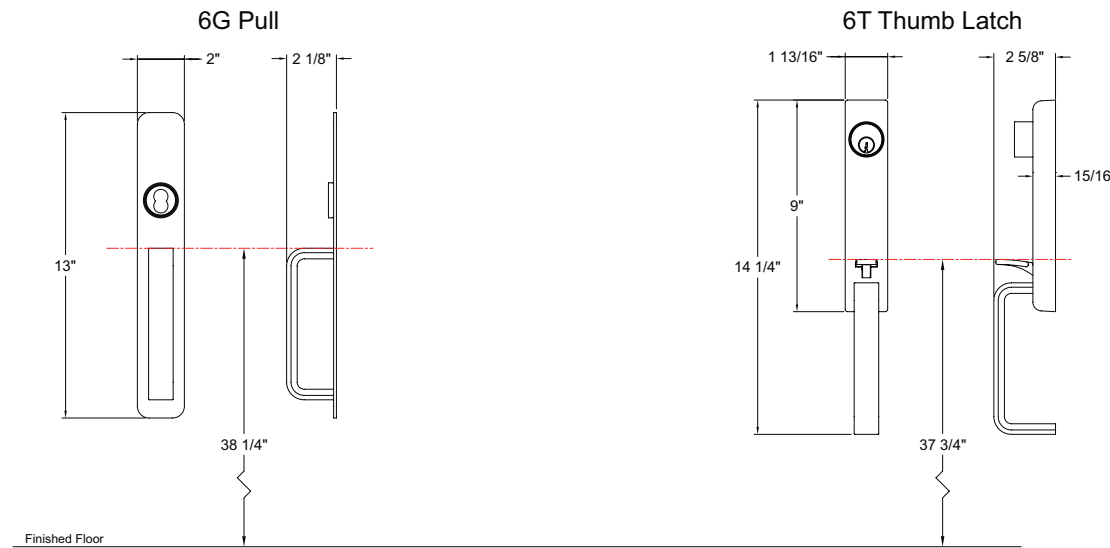
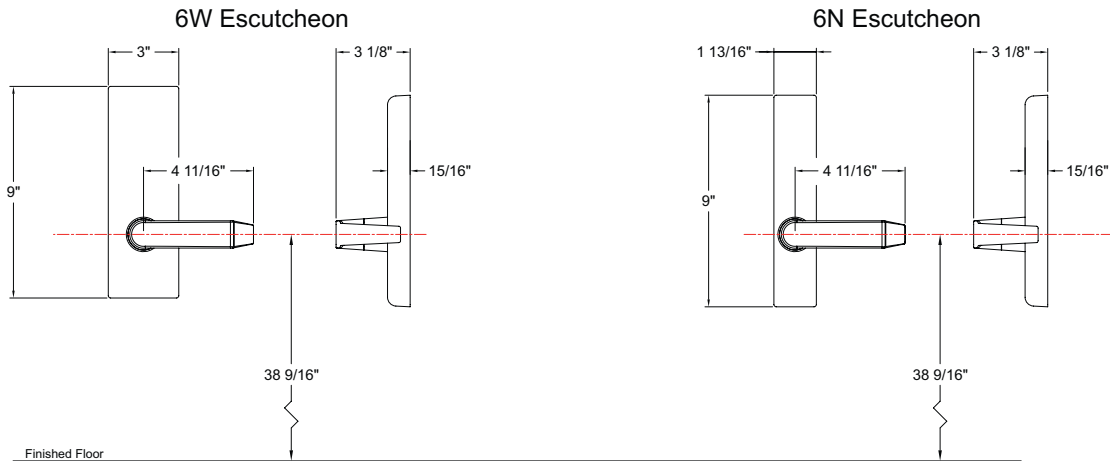

**6300/6400**  
EXIT DEVICE TRIMS

# 6300/6400 SERIES TRIMS

## LIST PRICE

Effective July 3, 2023

### Options

TRIM	PART	DESCRIPTION	TRIM ADJUSTMENT
All Trims	AM	Antimicrobial coating applied to tactile surfaces	\$90.00
6W, 6T, 6G, 6P, 6N	TD4	Trim adapted to accommodate 2-1/2"-2-3/4" thick doors	\$42.00
	TD5	Trim adapted to accommodate up to 3" thick doors	
All Except 6C	W	Weatherized Finish	\$80.00

### Keyways

Conventional Cylinder		Small Format Interchangeable Core		Large Format Interchangeable Core			
Keyway	PDQ Keyway Designator	Keyway (BEST Compatible)	PDQ Keyway Designator	Keyway (Schlage Compatible)	PDQ Keyway Designator		
Schlage C (Default)	SCC	BEST A (Default), B, C, D, E, F, G, H, J, K, L, M, Q, R, WA, WB, WG, WH, TB, TD, TE, R	A (Default), B, C, D, E, F, G, H, J, K, L, M, Q, R, WA, WB, WG, WH, TB, TD, TE, R	Schlage C (Default)	SCC (Default)		
PDQ Restricted	TA						
Arrow AR1	ARA						
Corbin 59A1	CO59A1						
Corbin 60	CO6						
Corbin L4	CL4						
Russwin D1	RUD			PDQ Exclusive	PDQ1		
Russwin 981	RUD981				PDQ2		
Schlage E	SCE			PDQ Exclusive and Restricted	PDQ3		
Schlage C	SCC						
Schlage C-K	SCC-K						
Sargent LA	SAL						
Sargent RA-RC	RA-RC						
Yale E1R	YA8						
Yale GA	GA						
Falcon E-R	FAL						
Kwikset	KW						

### Keying

Description	PDQ Keying Designator
Keyed Different (Default)	KD
Keyed Alike	KA
"O" Zero Bitted	KO
Master Keyed	MK
Construction Master Keyed	CMK
Grand Master Keyed	GMK

6300/6400  
EXIT DEVICE TRIMS

### Keyways and Cylinders

PDQ KEYWAY	COMPATIBLE WITH	SOLD WITH LOCK
AR1	Arrow / AR1	N/C
CO59A1	Corbin / 59A1	
CO6	Corbin / 60	
CL4	Corbin / L4	
RUD	Russwin / D1	
SCE	Schlage / E	
SCC	Schlage / C	
SCC-K	Schlage / C-K	
SAL	Sargent / LA	
RA-RC	Sargent / RA-RC	
YA8	Yale / E1R	
GA	Yale / GA	
FAL	Falcon / E-R	
KW	Kwikset	
TA	PDQ / TA (Restricted. Limited to Grandmaster systems w/4 masters)	
Dummy	—	
T-Turn	—	
L	Less Cylinder	

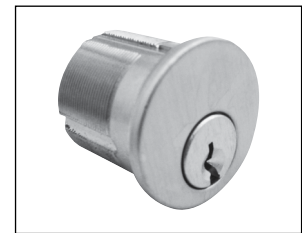

Mortise Cylinder



UL 437 and High Security Cylinders

**HIGH SECURITY CYLINDERS AND CORES**  
SEE HIGH SECURITY CYLINDERS AND CORES SECTION, PAGE 118.

- NOTES:**
- Uncombined cores do not include springs & pins
  - Combined cores include master keying in the list price
  - **PDQ1, PDQ2, PDQ3 (Restricted)**  
BEST A2 & A4 Systems Available
  - Control Keys must be ordered separately

### Cores and Keyways

DESCRIPTION	PDQ NO.	ADD
<b>SMALL FORMAT UNCOMBINED</b>		
6 Pin Cores	I5206 + KEYWAY	\$40.00
7 Pin Cores	I5207 + KEYWAY	
<b>COMBINATED</b>		
6 Pin Cores	I5206-1 + KEYWAY	\$60.00
7 Pin Cores	I5207-1 + KEYWAY	
<b>BEST<sup>®</sup> Compatible</b>		
A (DEFAULT), B, C, D, E, F, G, H, J, K, L, M, Q,		
WA, WB, WC, WG, WH, TB, TD, TE, & R		
<b>PDQ Exclusive</b>		
PDQ1, PDQ2		
<b>PDQ Exclusive and Restricted</b>		
PDQ3		
<b>SFIC CONSTRUCTION</b>		
Construction Core 6-pin only		\$60.00
Dummy Construction Core Plastic		\$8.00
<b>LFIC CONSTRUCTION</b>		
Construction Core 6-pin only		\$70.00
<b>IC Tailpiece Assembly Construction cores are invoiced at shipment and credited upon return.</b>		
		\$10.00
<b>LFIC COMBINATED</b>		
Schlage compatible LFIC, SCC (Schlage C compatible) keyway		\$70.00
PDQ TA LFIC Restricted		
<b>LFIC UNCOMBINED</b>		
Schlage compatible LFIC, SCC (Schlage C compatible) keyway		\$50.00
<b>HIGH SECURITY IC CORES</b>		
SEE HIGH SECURITY CYLINDERS AND CORES SECTION, PAGE 118. — LFIC REQUIRES LARGE FORMAT LEVER		

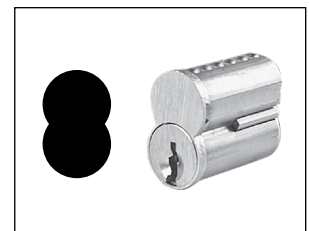

SFL/SFIC Core

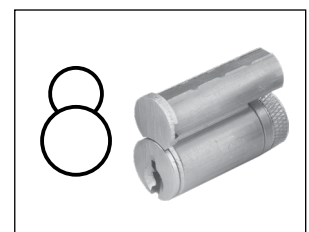

LFL/LFIC Schlage Format





IC Mortise Housing

# 6300/6400 SERIES TRIMS

# LIST PRICE

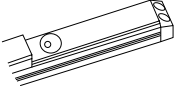
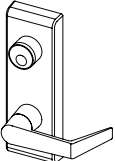
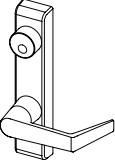
Effective July 3, 2023

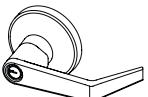
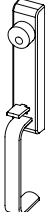
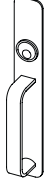
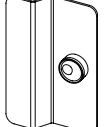
TRIM TYPE	FUNCTION	IMAGE	STANDARD CYLINDER	BEST SFIC	SCHLAGE STYLE LFIC
<b>6C</b>	03 (Less Outside Trim)		Rim cylinder (use rim cylinder included collar, mounting plate & screws)	SFIC Rim Housing (use rim housing included collar, mounting plate & screws)	LFIC Rim Housing (use rim housing included collar, mounting plate & screws)
<b>CYLINDER DOGGING/ALARM KIT</b>	All Devices		1-1/8" Mortise Cylinder 631093 Trim Ring Yale Cam	SFIC 7 pin housing (2) 631093 Trim Rings Yale Cam	LFIC housing 631094 Collar (5/8") Yale Cam
<b>6W</b>	All Keyed Functions		1-1/8" Mortise Cylinder 631094 Collar (5/8")  Corbin A01 or Yale Cam	SFIC 7 pin housing 631094 Collar Flipped (3/4") 631093 Trim Ring  Corbin A01 or Yale Cam	LFIC housing 631094 Collar Flipped (3/4") 631093 Trim Ring Corbin A01 or Yale Cam
<b>6N</b>	08, 09		1-1/8" Mortise Cylinder 631094 Collar (5/8")  Corbin A01 or Yale Cam	SFIC 7 pin housing 631094 Collar Flipped (3/4") 631093 Trim Ring  Corbin A01 or Yale Cam	LFIC housing 631094 Collar Flipped (3/4") 631093 Trim Ring Corbin A01 or Yale Cam
<b>6N</b>	03		Rim Cylinder	SFIC rim housing	LFIC rim housing
<b>6S</b>	All Keyed Functions		Must order product with KIK / Standard cylinder lever	Must order product with SFIC lever	Must order product with Schlage style LFIC Lever
<b>6T</b>	All Keyed Functions		1-1/8" Mortise Cylinder 631094 Collar (5/8")  Corbin A01 or Yale Cam	SFIC 7 pin housing 631094 Collar Flipped (3/4") 631093 Trim Ring Corbin A01 or Yale Cam	LFIC housing 631094 Collar Flipped (3/4") 631093 Trim Ring Corbin A01 or Yale Cam
<b>6G</b>	All Keyed Functions		Rim Cylinder Standard rim cylinder trim ring	SFIC rim housing Standard rim cylinder trim ring	LFIC rim housing Standard rim cylinder trim ring
<b>6P</b>	All Keyed Functions		Rim Cylinder Standard rim cylinder trim ring	SFIC rim housing Standard rim cylinder trim ring	LFIC rim housing Standard rim cylinder trim ring

6300/6400  
EXIT DEVICE TRIMS

### Trim Compatibility (Narrow/Medium Stile Aluminum Doors)

Stile	Device Type	Compatible Trims
2 - 1/8" Stile Doors	6400 Narrow Stile Devices	6C Cylinder only: Function (03)
		6C Cylinder with 9E Pull: Function (03) Note: Pull for 6400 CVR Device must be 10"CTC
3 - 1/2" Stile Doors	6400 Narrow Stile Devices	6C Cylinder only: Function (03)
		6C Cylinder with 9E Pull: Function (03) Note: Pull for 6400 CVR Device must offset from device centerline if other than 10"CTC
		6N Escutcheon: Function (01, 02, 03, 08, 09, 14)
		6T Escutcheon: Function (02, 05, 06, 15) Note: This trim does not work on 6400 CVR Device
		6G Pull: Function (02, 03)
3 - 1/2" Stile Doors	6300 Wide Stile Devices	6C Cylinder only: Function (03)
		6C Cylinder with 9E Pull: Function (03)
		6W Escutcheon: Function (02, 08, 09, 14, 99)
		6N Escutcheon: Function (01, 02, 03, 08, 09, 14)
		6T Escutcheon: Function (02, 05, 06, 15)
		6P Pull: Function (03)
		6G Pull: Function (02, 03)

### Trim Compatibility (Steel/Wood Doors)

Device Type	Compatible Trims
6400 Narrow Stile Devices	6C Cylinder only: Function (03)
	6C Cylinder with 9E Pull: Function (03)
	6N Escutcheon: Function (01, 02, 03, 08, 09, 14)
	6T Escutcheon: Function (02, 05, 06, 15) Note: This trim does not work on 6400 CVR Device
	6G Pull: Function (02, 03)
6300 Wide Stile Devices	6C Cylinder only: Function (03)
	6C Cylinder with 9E Pull: Function (03)
	6W Escutcheon: Function (02, 08, 09, 14, 99)
	6N Escutcheon: Function (01, 02, 03, 08, 09, 14)
	6T Escutcheon: Function (02, 05, 06, 15)
	6P Pull: Function (03)
	6G Pull: Function (02, 03)

# 9300 SERIES

# Mullions

## 9300 Mullion

The PDQ 9300 Series removable mullions are designed for use with the 6300/6400 Series Rim Exit Devices on pairs of doors. They are designed for quick removal from the top bracket by simple operation of the rim cylinder when a clear, unobstructed large opening is required. Once the mullion is removed, carts, gurneys, large machinery and the like can freely pass through the opening. When the mullion is re-installed, the unit will self lock in place without a key.

## Specifications

<b>Mullion Head/Foot brackets:</b>	<ul style="list-style-type: none"> <li>• Cast Stainless Steel</li> </ul>
<b>Tube Dimensions:</b>	<ul style="list-style-type: none"> <li>• Powder Coated 2" x 3" Steel - 3/16" Wall</li> </ul>
<b>Strike:</b>	<ul style="list-style-type: none"> <li>• 639080 Strike included for Fire Labeled • Strike not included for panic mullion. Use supplied strike with exit device.</li> </ul>
<b>Size:</b>	<ul style="list-style-type: none"> <li>• 8' or 10' lengths - Can easily be cut to shorter size in field</li> </ul>
<b>Finish:</b>	<ul style="list-style-type: none"> <li>• Powder Coated 689 (Aluminum)</li> <li>• 600 - Primed for Painting</li> </ul>
<b>Electrified Options:</b>	<ul style="list-style-type: none"> <li>• Wire routing w/ plugs</li> </ul>
<b>Warranty:</b>	<ul style="list-style-type: none"> <li>• One (1) year limited warranty</li> </ul>
<b>Certifications: Compliances: Listings:</b>	<ul style="list-style-type: none"> <li>• Fire model is 3 hour fire labeled for pairs up to and including 8' x 8' (With 6300RF/6400RF Rim Device)</li> <li>• Meets requirements of the BAA as a COTS product manufactured in the United States</li> </ul>

## Orientation

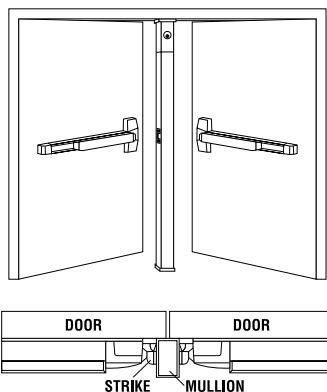

Key Removable



Non-Keyed Removable

## How to order

DEVICE TYPE	FOR DOOR HEIGHT	REMOVABLE TYPE	RATING	FINISH	OPTIONS	KEYING
93	0	0	—	<b>689</b>	—	
<b>93</b> - Mullion	<b>0</b> - 8' and under Door <b>1</b> - 10' and under Door	<b>0</b> - Key Removable <b>1</b> - Non-Keyed Removable	<b>Blank</b> - Non Fire Rated <b>F</b> - Fire Rated (8' Max)	<b>689</b> - Aluminum <b>600</b> - Primer	<b>EM</b> - Electrified Mullion	<b>See Next Page</b>

## Mullions - Key Removable

PART	DESCRIPTION	689/600
9300-689	Mullion, 8' non-fire rated and under opening height (can be cut down to non standard opening height)	\$1065.00
9300F-689	Mullion, 8' Listed to UL10C for Fire and under opening height (can be cut down to non standard opening height)	\$1325.00
9310-689	Mullion, 10' and under opening height (can be cut down to non standard opening height)	\$1204.00

## Mullions - Hex Key Removable

PART	DESCRIPTION	689/600
9301-689	Mullion, 8' and under opening height (can be cut down to non standard opening height)	\$771.00
9301F-689	Mullion, 8' Listed to UL10C for Fire and under opening height (can be cut down to non standard opening height)	\$1031.00
9311-689	Mullion, 10' and under opening height (can be cut down to non standard opening height)	\$910.00

## Electrified Mullion



PART	DESCRIPTION	689/600
9300-689-EM	Mullion, removable by cylinder, 8' and under opening height (can be cut down to non standard opening height), Factory electrified routing prep using Industry standard moxex connectors	\$1348.00
9300F-689-EM	Mullion, Listed to UL10C for Fire, removable by cylinder, 8' and under opening height (can be cut down to non standard opening height), Factory electrified routing prep using Industry standard moxex connectors	\$1608.00
9301-689-EM	Mullion, removable by use of hex key, 8' and under opening height (can be cut down to non standard opening height), Factory electrified routing prep using Industry standard moxex connectors	\$1054.00
9301F-689-EM	Mullion, Listed to UL10C for Fire, removable by use of hex key, 8' and under opening height (can be cut down to non standard opening height), Factory electrified routing prep using Industry standard moxex connectors	\$1314.00
9310-689-EM	Mullion, removable by cylinder, 10' and under opening height (can be cut down to non standard opening height), Factory electrified routing prep using Industry standard moxex connectors	\$1487.00
9311-689-EM	Mullion, removable by use of hex key, 10' and under opening height (can be cut down to non standard opening height), Factory electrified routing prep using Industry standard moxex connectors	\$1193.00

**Notes:**

- 1. Fire Rated mullion listed only when used with PDQ's 6300/6400 Fire Rated Devices. Use with any other device will void UL Fire Rating.**
- 2. Mullions shipped UPS will be assessed an \$8.00 handling up charge.**

### Key Removable Only

CYLINDER TYPE	KEYWAY	KEYING
D	SCC	KD
<b>D</b> Default <b>L</b> Less Cylinder <b>SF6</b> Lock is SFIC prepped w/ 6 pin core <b>SF7</b> Lock is SFIC prepped w/ 7 pin core <b>SFL</b> Lock is SFIC prepped but less core <b>SFC</b> Lock is SFIC prepped w/ construction core <b>SFP</b> Lock is SFIC prepped w/ plastic construction core <b>LF6</b> Lock is Schlage LFIC prepped w/ Schlage core <b>LFL</b> Lock is Schlage LFIC prepped but less core <b>LFC</b> Lock is Schlage LFIC prepped w/ construction core	<b>SCC</b> – Schlage C <b>OTHERS</b> – See Keyway Table Page 176	<b>KD</b> – Keyed Different <b>KA</b> – Keyed Like <b>KO</b> – Zero Bitted <b>MK</b> – Master Keyed <b>CMK</b> – Construction Keyed <b>GMK</b> – Grand Master Keyed

CYLINDER OPTIONS	ICON	LOCK ADJUSTMENT
SFL		N/C
LFL		
D		

IC Core not included.

### 639081 - Mullion Storage Kit

- Kit includes items necessary to mount/store mullion on the wall when not in use.



### Accessories

PART	DESCRIPTION	LIST PRICE
631617	Mullion Fire Strike (Includes fasteners)	\$50.00
639081	Mullion Storage Kit	\$188.00

**Note:** Strike sold as replacement only. Must provide Order number of previous purchased item.





# 4200 Series Commercial Wide Stile

## Architectural Finishes. No Plastic Parts.

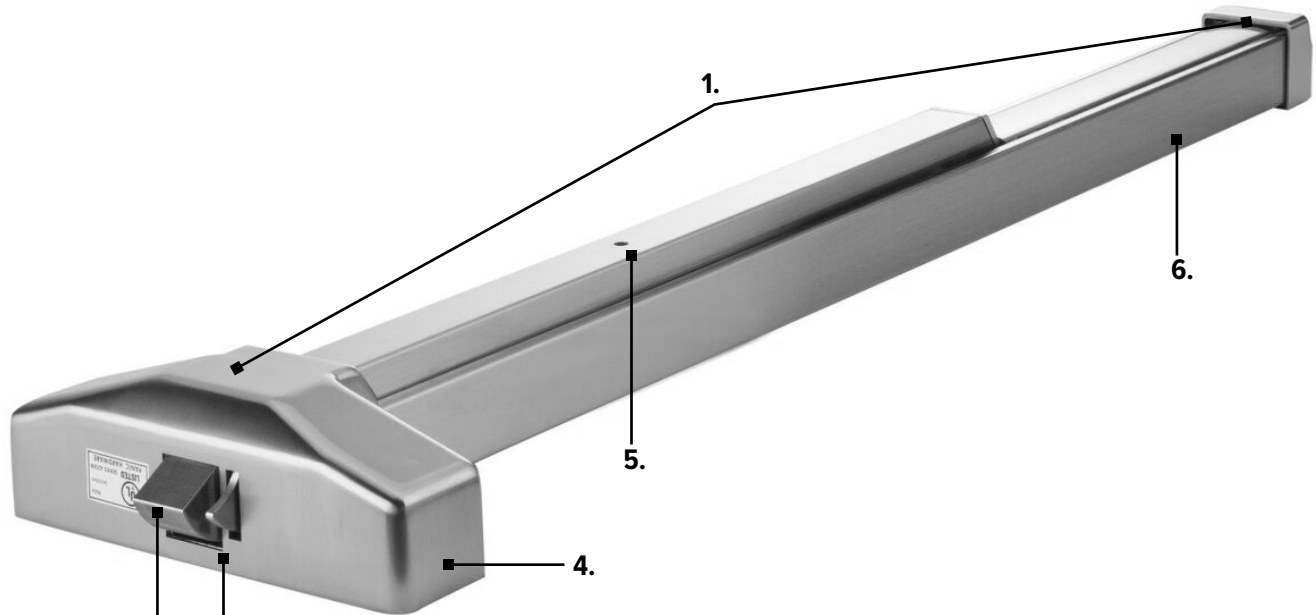

- 1. Metal end caps and chassis cover
- 2. Stainless steel latch bolt with 3/4" throw (rim shown), 5/8" throw (vertical rod devices)
- 3. Deadlocking feature provides tamper resistance (rim shown)
- 4. Corrosion resistant steel plated chassis
- 5. Hex key dogging (Dogging not available with fire labeled devices)
- 6. Heavy gauge roll formed steel or stainless steel rail

### Decorative Finish Collection

#### Architectural

- 626 Satin Chromium Plated
- 630 Satin Stainless Steel

#### Painted

- 689 Aluminum
- 695 Dark Bronze
- 696 Gold



## How to Order

QUANTITY	SERIES	DOGGING	APPLICATION	LABELING	SIZE	FINISH
10	42	00	R	F	A	630
		<b>00</b> – Hex Key Dogging (Standard) Dogging Not Furnished With Fire Listed Devices	<b>R</b> – Rim <b>V</b> – Surface Vertical Rod	<b>F</b> – Fire Listed, Max. 3' Door Width and 7' Door Height  <b>No Designation</b> – Panic	<b>BLANK</b> – 3' doors (Default) <b>A</b> – Doors up to 4' Consult Door Width Chart to determine correct device for your application	<b>626</b> – Satin Chrome <b>630</b> – Satin Stainless Steel <b>689</b> – Aluminum <b>695</b> – Duro Bronze <b>696</b> – Gold

## Door Width Chart

PART	DESCRIPTION	FOR DOOR	MIN DOOR	MAX CUT	PUSH PAD
4200R	4200 Rim Regular dogging	36"	27"	9"	18"
4200RF	4200 Rim Fire Listed	36"	27"	9"	18"
4200V	4200 SVR Regular dogging	36"	27"	9"	18"
4200VF	4200 SVR Fire Listed	36"	27"	9"	18"
4200RA	4200 Rim Regular dogging	48"	39"	9"	30"
4200VA	4200 SVR Regular dogging	48"	39"	9"	30"

## Cross Reference

DESCRIPTION	PDQ	CAL ROYAL	CORBIN/RUSSWIN	DORMA	FALCON	HAGER	PRECISION	SARGENT	S PARKER	TELL	VON DUPRIN	ACCENTRA
RIM	4200R	2200	ED8200	8300	19 R	4700 Rim	5100	2828	UL520	8300	22	2100
SURFACE VERTICAL ROD	4200V	2260	ED8400	8400	19 V	4700 SVR	5200	2727	520V	8400	2227	2110

# 4200R SERIES

## Commercial Wide Stile Rim Exit Device



**RIM**  
ANSI TYPE 1



### Specifications

<b>CHASSIS:</b>	• Corrosion resistant plated steel
<b>RAIL:</b>	• Heavy gauge steel or stainless steel
<b>LATCH:</b>	• RIM (R) – 3/4" throw
<b>BACKSET:</b>	• 2-3/4" Backset Compatible with 161 prep
<b>HAND:</b>	• Device is non-handed
<b>DOGGING:</b>	• Hex key dogging standard • Dogging not available on fire listed devices
<b>MINIMUM STILE WIDTH:</b>	• 4-1/4" for device (exit only) • Minimum stile requirements with trim varies by trim type
<b>DOOR THICKNESS:</b>	• 1-3/4" standard
<b>DOOR WIDTH:</b>	• Standard for 3 ft doors, option available for doors up to 4'
<b>FINISHES:</b>	• 626 – Satin Chrome, 630 – Satin Stainless Steel, 689 – Aluminum, 695 - Duro Bronze, 696 – Gold
<b>FASTENERS:</b>	• Includes machine screws and wood screws • Sex nuts supplied with all Fire Listed devices
<b>WARRANTY:</b>	• Five (5) year limited warranty
<b>CERTIFICATIONS, LISTINGS, COMPLIANCES:</b>	• UL 305 listed for "Panic" , UL listed for "Fire Exit Hardware" labeled for up to 1-1/2 hours, 3'0" x 7'0" Max Size • Complies with ADA (Americans with Disabilities Act) and ICC/ANSI 117.1 for Accessible and Usable Buildings • TAA compliant. Country of origin: Taiwan

### Rim Exit Device

PART	DESCRIPTION	689/695/696	630	626
4200R	Rim, UL panic listed, hex key dogging, 3'0" door	\$282.00	\$442.00	\$382.00
4200RA	Rim, UL panic listed, hex key dogging, 4'0" door	\$324.00	\$484.00	\$424.00
4200RF	Rim, UL fire listed, no dogging, 3'0" door	\$433.00	\$593.00	\$533.00

# 4200V SERIES

## Commercial Wide Stile Surface Vertical Rod Exit Device

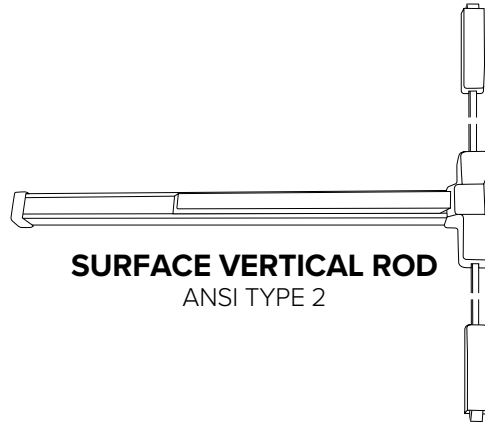

**SURFACE VERTICAL ROD**  
ANSI TYPE 2



### Specifications

<b>CHASSIS:</b>	• Corrosion resistant plated steel
<b>RAIL:</b>	• Heavy gauge steel or stainless steel
<b>LATCH:</b>	• SURFACE VERTICAL ROD (V) – Top Latch-Pullman with dead latching 5/8" throw - Bottom Latch- Pullman with 5/8" throw, held retracted during door swing
<b>BACKSET:</b>	• 2-3/4" Backset Compatible with 161 prep
<b>HAND:</b>	• Device is non-handed
<b>DOGGING:</b>	• Hex key dogging standard • Dogging not available on fire listed devices
<b>MINIMUM STILE WIDTH:</b>	• 4-1/4" for device (exit only) • Minimum stile requirements with trim varies by trim type
<b>DOOR THICKNESS:</b>	• 1-3/4" standard
<b>DOOR WIDTH:</b>	• Standard for 3 ft doors, option available for doors up to 4'
<b>FINISHES:</b>	• 626 – Satin Chrome, 630 – Satin Stainless Steel, 689 – Aluminum, 695 - Duro Bronze, 696 – Gold
<b>FASTENERS:</b>	• Includes machine screws and wood screws • Sex nuts supplied with all Fire Listed devices
<b>VERTICAL RODS:</b>	• Stock for 7' doors standard. Rod extensions available for doors up to 10'.
<b>WARRANTY:</b>	• Five (5) year limited warranty
<b>CERTIFICATIONS, LISTINGS, COMPLIANCES:</b>	• UL 305 listed for "Panic", UL listed for "Fire Exit Hardware" labeled for pair of doors up to 1-1/2 hours, 6'0" x 7'0" Max Opening • Complies with ADA (Americans with Disabilities Act) and ICC/ANSI 117.1 for Accessible and Usable Buildings • TAA compliant. Country of origin: Taiwan

### Surface Vertical Rod Exit Device

PART	DESCRIPTION	689/695/696	630	626
4200V	Surface vertical rod, UL panic listed, hex key dogging, 3'0" door	\$539.00	\$699.00	\$639.00
4200VA	Surface vertical rod, UL panic listed, hex key dogging, 4'0" door	\$581.00	\$741.00	\$681.00
4200VF	Surface vertical rod, UL fire listed, no dogging, 3'0" door	\$690.00	\$850.00	\$790.00

# 4200 SERIES

# Commercial Wide Stile Exit Device Trim

## Lever Styles



BOSTON — BSN  
4S TRIM ONLY



MIAMI — MIA  
4S TRIM ONLY



PHILADELPHIA — PHL

**ALL LEVERS**

## Trim Types



EW - ESCUTCHEON  
WIDE



EN - ESCUTCH-  
EON NARROW



GW - GRIP PULL  
WIDE



S - SECTIONAL  
LEVER



P03 - PULL



P02 - PULL



P01 - PLATE



K - SECTIONAL KNOB

## How to Order

QUANTITY	SERIES	TYPE	FUNCTION	LEVER	HANDING	FINISH	DOOR THICKNESS	CYLINDER OR HOUSING	KEYWAY	KEYING
10	4	EW	08	PHL	—	626	—	D	SCC	KD
		<b>K</b> — Knob <b>GW</b> — Grip Pull, Wide Stile <b>P01</b> — Plate <b>P02</b> — Pull <b>S</b> — Sectional, Heavy Duty <b>EN*</b> — Escutcheon, Narrow <b>EW*</b> — Escutcheon, Wide	<b>01</b> — Exit only <b>02</b> — Dummy Trim <b>03</b> — Night Latch <b>05</b> — Classroom w/Thumb Piece <b>08</b> — Classroom w/Lever <b>09</b> — Storeroom w/Lever <b>14</b> — Passage w/Lever <b>15</b> — Passage w/Thumb Piece	<b>BSN</b> — Boston <b>MIA</b> — Miami <b>PHL</b> — Philadelphia	<b>RHR</b> <b>LHR</b>	<b>606</b> — Satin Brass <b>613E</b> — Dark Oxidized Satin Bronze (Equivalent) <b>626</b> — Satin Chrome <b>630</b> — Satin Stainless Steel	<b>1- 3/4 - 2"</b>	<b>D</b> Default <b>L</b> Less Cylinder <b>SF6</b> Lock is SFIC prepped w/ 6 pin core <b>SF7</b> Lock is SFIC prepped w/ 7 pin core <b>SFL</b> Lock is SFIC prepped but less core <b>SFC</b> Lock is SFIC prepped w/ construction core <b>SFP</b> Lock is SFIC prepped w/ plastic construction core <b>LF6</b> Lock is Schlage LFIC prepped w/ Schlage core <b>LFL</b> Lock is Schlage LFIC prepped but less core <b>LFC</b> Lock is Schlage LFIC prepped w/ construction core	PAGE 183	
									PAGE 183	

\* EN/EW trim available with PHL lever only.





### Wide Stile Trim

STYLE		FUNCTION	DESCRIPTION	TRIM TYPE	613E	626	689/695
4EW		02	Dummy Trim (Rigid Lever)	4 EW 02 PHL	\$304.00	\$289.00	-
		08	Classroom w/ Lever	4 EW 08 PHL	\$317.0	\$302.00	
		09	Storeroom w/ Lever	4 EW 09 PHL			
		14	Passage w/ Lever	4 EW 14 PHL	\$304.00	\$289.00	
4EN		02	Dummy Trim (Rigid Lever)	4 EN 02 PHL	-	\$149.00	\$134.00
		08	Classroom w/ Lever	4 EN 08 PHL		\$167.00	\$152.00
		09	Storeroom w/ Lever	4 EN 09PHL			
		14	Passage w/ Lever	4 EN 14 PHL		\$149.00	\$134.00



STYLE		FUNCTION	DESCRIPTION	TRIM TYPE	606/613E	626	689/695
4S	 <p>Sectional lever trim not compatible when using SNB to through bolt device chassis</p>	02	Dummy Trim (Rigid Lever)	4 S 02 BSN, MIA, PHL	\$150.00	\$135.00	-
		08	Classroom w/ Lever	4 S 08 BSN, MIA, PHL	\$204.00	\$189.00	
		09	Storeroom w/Lever	4 S 09 BSN, MIA, PHL			
		14	Passage w/ Lever	4 S 14 BSN, MIA, PHL	\$150.00	\$135.00	

Note: For functions and finishes not shown, contact PDQ Customer Service.

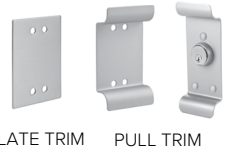

CYLINDER OPTIONS	ICON	LOCK ADJUSTMENT
SFL		N/C
LFL		
D		

IC Core not included see page 192 for core options.

### Wide Stile Trim

STYLE	FUNCTION	DESCRIPTION	TRIM TYPE	613E	626	630	689/695
4K 	08	Classroom	4 K 08	-		\$74.00	-
	14	Passage	4 K 14				
4P 	01	Exit Only	4 P 01		-	\$36.00	\$36.00
	02	Dummy Pull Trim	4 P 02				
	03	Night Latch	4 P 03				
4GW 	02	Dummy Trim (Grip Pull only)	4 GW 02	-	\$169.00	-	\$154.00
	03	Night Latch	4 GW 03				
	05	Classroom w/Thumb Piece	4 GW 05		\$199.00		\$184.00
	15	Passage w/Thumb Piece	4 GW 15		\$169.00		\$154.00

\* Specify handing. For functions and finishes not shown, contact PDQ Customer Service.

CYLINDER OPTIONS	ICON	LOCK ADJUSTMENT
SFL		N/C
LFL		
D		

IC Core not included see page 183 for core options

### Accessories

PART (SPECIFY FUNCTION)	DESCRIPTION	LIST PRICE PLATED (626/630)	LIST PRICE PAINTED (689/695/696)
429020	Top surface vertical rod for 7'0" door	\$56.00	\$44.00
429021	1' extension, vertical rod (specify finish)*		
429023	3' extension, vertical rod (specify finish)*		
429024	Bottom surface vertical rod (specify finish)*		
429001	Sex nut and bolt set	\$33.00	\$21.00
429002	Plate, Latch Filler-covers Type 160 or 161 prep	\$10.00	N/A
429003	Plate, Strike filler		
429005	Strike, SVR Top, Fire and Panic w/2 ea. 1/16" shims	\$17.00	
429006	Strike, SVR Bottom, Fire and Panic w/2 ea. 1/16" shims		
429036	Strike, Rim, Fire and Panic		
429019	Double door strike	\$33.00	
429014	Trim back plate (2-1/2" x 8"), use w/narrow escutcheon to cover 161 prep	\$21.00	
429017	Trim back plate (3-1/2" x 8"), use w/narrow escutcheon to cover 161 prep	\$42.00	
429018	Adapter plate	\$10.00	
429150	Universal Glass Bead Kit - Includes 2 ea. 1/8" spacers for chassis, end cap and rod guides.	\$79.00	
429043	Dogging Key	\$8.00	

\*Not for Fire Rated Devices



# 4200 SERIES

## LIST PRICE

Effective July 3, 2023

### Keyways and Cylinders

PDQ KEYWAY	COMPATIBLE WITH	SOLD WITH LOCK	
AR1	Arrow / AR1	N/C	
CO59A1	Corbin / 59A1		
CO6	Corbin / 60		
CL4	Corbin / L4		
RUD	Russwin / D1		
SCE	Schlage / E		
SCC	Schlage / C		
SCC-K	Schlage / C-K		
SAL	Sargent / LA		
RA-RC	Sargent / RA-RC		
YA8	Yale / E1R		
GA	Yale / GA		
FAL	Falcon / E-R		
KW	Kwikset		
TA	PDQ / TA (Restricted. Limited to Grandmaster systems w/4 masters)		
Dummy	—		
T-Turn	—		
L	Less Cylinder		Deduct \$4.00
<b>HIGH SECURITY CYLINDERS AND CORES</b>			
SEE HIGH SECURITY CYLINDERS AND CORES SECTION, PAGE 118.			

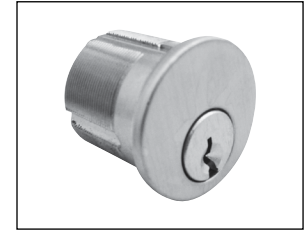

Mortise Cylinder



UL 437 and High Security Cylinders

#### NOTES:

- Uncombined cores do not include springs & pins
- Combined cores include master keying in the list price
- **PDQ1, PDQ2, PDQ3 (Restricted)**  
BEST A2 & A4 Systems Available
- Control Keys must be ordered separately

### Cores and Keyways

DESCRIPTION	PDQ NO.	ADD
<b>SMALL FORMAT UNCOMBINED</b>		
6 Pin Cores	I5206 + KEYWAY	\$40.00
7 Pin Cores	I5207 + KEYWAY	
<b>COMBINED</b>		
6 Pin Cores	I5206-1 + KEYWAY	\$60.00
7 Pin Cores	I5207-1 + KEYWAY	
<b>BEST™ Compatible</b>		
A (DEFAULT), B, C, D, E, F, G, H, J, K, L, M, Q,		
WA, WB, WC, WG, WH, TB, TD, TE, & R		
<b>PDQ Exclusive</b>		
PDQ1, PDQ2		
<b>PDQ Exclusive and Restricted</b>		
PDQ3		
<b>SFIC CONSTRUCTION</b>		
Construction Core 6-pin only		\$60.00
Dummy Construction Core Plastic		\$8.00
<b>LFIC CONSTRUCTION</b>		
Construction Core 6-pin only		\$70.00
IC Tailpiece Assembly Construction cores are invoiced at shipment and credited upon return.		
		\$10.00
<b>LFIC COMBINED</b>		
Schlage compatible LFIC, SCC (Schlage C compatible) keyway		\$70.00
PDQ TA LFIC Restricted		
<b>LFIC UNCOMBINED</b>		
Schlage compatible LFIC, SCC (Schlage C compatible) keyway		\$50.00
<b>HIGH SECURITY IC CORES</b>		
SEE HIGH SECURITY CYLINDERS AND CORES SECTION, PAGE 118. — LFIC REQUIRES LARGE FORMAT LEVER		

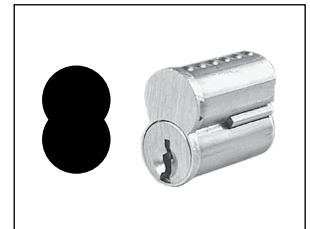

SFL/SFIC Core

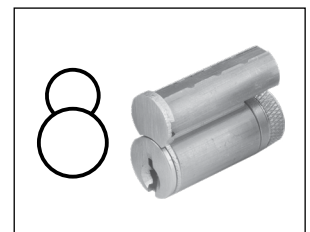

LFL/LFIC Schlage Format



IC Mortise Housing

4200 SERIES  
EXIT DEVICE TRIMS



## ANSI Trim Functions

ANSI FUNCTION	DESCRIPTION
01	Exit only, no trim or blank escutcheon.
02	Entrance by trim when actuating bar is locked down (dummy trim).
03	Entrance by trim when latch is released by key. Key removable only when locked (night latch).
05	Entrance by thumb piece. Key locks or unlocks thumb piece (classroom thumb piece).
08	Entrance by knob or lever. Key locks or unlocks knob or lever (classroom knob/lever).
09	Entrance by knob or lever only when released by key. Key removable when locked.
14	Entrance by trim when latch bolt is released by knob or lever. Always active, no cylinder (passage knob/lever).
15	Entrance by trim when latchbolt is released by thumb piece. Always active, no cylinder (passage thumb piece).

\*All functions not available in every trim style

## Finishes

CODE	TYPE	DESCRIPTION
613E	Architectural	Dark Oxidized Satin Bronze (Equivalent), No Coating
626 (US26D)	Architectural	Satin Chromium Plated, No Coating
630 (US32D)	Architectural	Satin Stainless Steel, No Coating
689 (US28)	Color	Aluminum
695 (None)	Color	Dark Duranodic Bronze

\*All finishes not available in every trim style

## Handing

Out Swing Door

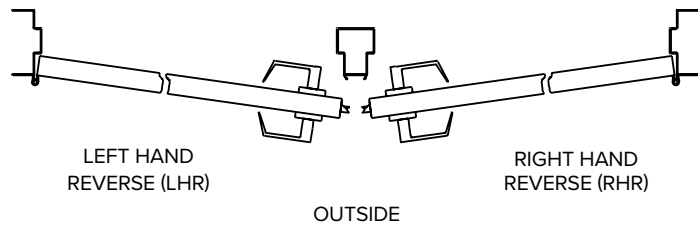

## Default Trim Cylinder Reference Guide

ANSI FUNCTION	DESCRIPTION	EW ESCUTCHEON WIDE	EN ESCUTCHEON NARROW	S SECTIONAL LEVER	P PLATE	GW GRIP PULL, WIDE STILE	K SECTIONAL KNOB
03	Night Latch	—	—	—	RIM	RIM	—
05	Classroom w/Thumb Piece	—	—	—	—	Mortise	—
08	Classroom w/Lever	Mortise	Mortise	Key in Knob/Lever	—	—	Key in Knob/Lever
09	Storeroom w/Lever	Mortise	—	Key in Knob/Lever	—	—	—

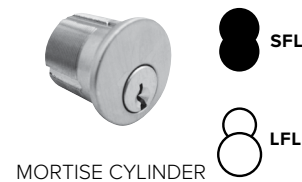
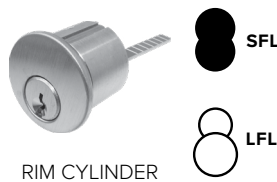
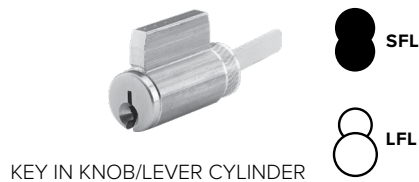

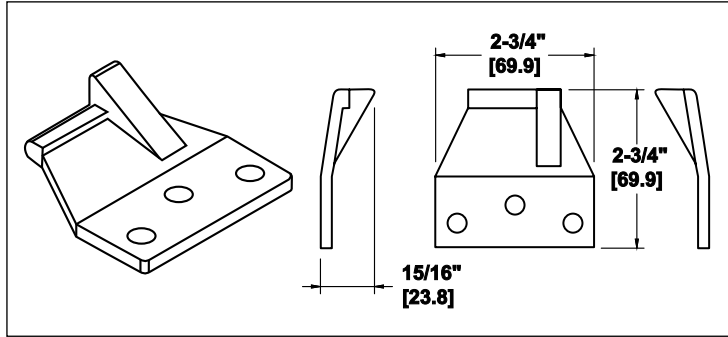

429019 DOUBLE DOOR STRIKE

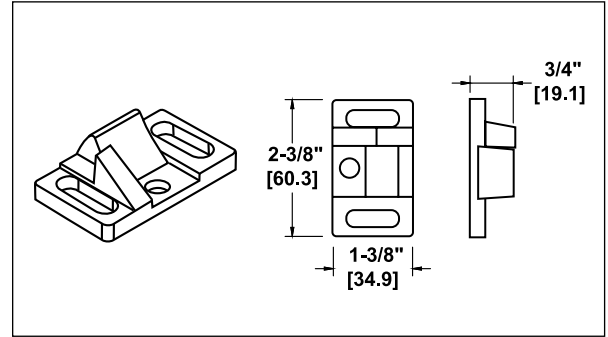

429005 SVR TOP STRIKE W/2 SHIMS PANIC AND FIRE

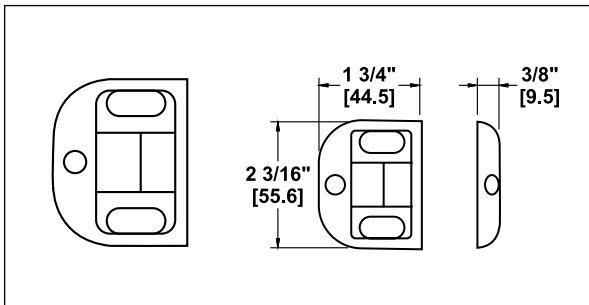

429006 SVR BOTTOM STRIKE  
W/2 SHIMS PANIC AND FIRE

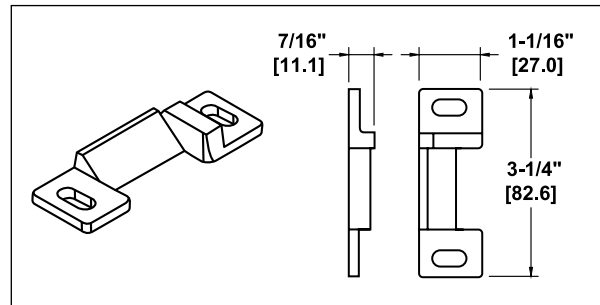

429036 RIM STD.  
(2-3/4" BACKSET) FIRE & PANIC

## Making Door Control Easy

PDQ offers a comprehensive line of door closers designed and manufactured to ensure superior performance and reliability. They offer the perfect combination of reliability, appearance, and durability. With a wide range of models and features, PDQ has a door closer for most applications.

### Comprehensive Offering

#### 7100 Institutional



##### Applications

**7100** — The 7100 Series is PDQ's top of line heavy duty closer. It is designed for high use, high abuse institutional applications such as K-12, higher education and government buildings. 7100 Series closers are ideal for retrofit and new construction applications where strength and durability are required.

#### 5100 Institutional



##### Applications

**5100** — **5100** Series Door Closer is a heavy duty multi-feature closer that is perfect for high use, high abuse applications such as K-12, higher education, and government buildings. The 5100's compact design is ideal for interior door applications where it's distinctive lines harmonize with most decors.

#### 5500 Commercial



##### Applications

**5500 (Full cover)** — Designed for maximum versatility, the 5500 Series sports a full cover and can be used for both commercial and institutional applications. This rugged workhorse is perfect for high traffic applications including federal/state buildings, assisted living facilities, hospitality, retail, religious, and medical buildings.

#### 5300 Commercial



##### Applications

**5300 (Slim cover)** — The aesthetically pleasing 5300 Series comes standard with a slim line cover and offers the ideal combination of appearance, reliability, and durability for today's market. This rugged closer is perfect for high traffic applications such as healthcare, hospitality, government, assisted living, retail, and religious facilities.

#### 3100 Light Commercial



##### Applications

**3100** — Designed for medium-light duty applications, the 3100 Series is ideal for aluminum storefronts, interior offices, multi family, hospitality and many other applications. The 3100 combines dependable operation, low maintenance and stylish look.

# 7100 SERIES

# Grade 1 Heavy Duty Closer

## Typical Applications

- Assisted Living
- Higher Education
- High Use/High Abuse Situations
- K-12 Education
- Military and Government
- Multi-family
- Offices
- Public Buildings

## Features

- Features a 1-1/2" (38mm) diameter hardened steel pinion
- Heavy duty, fully featured architectural style door control
- High strength cast iron body and forged steel arm assembly provide maximum durability and reliability in the most brutal environments
- Backcheck positioning valve feature provides a consistent backcheck snubbing range for regular, top jamb and parallel arm applications, preventing costly damage during forceful opening of the door

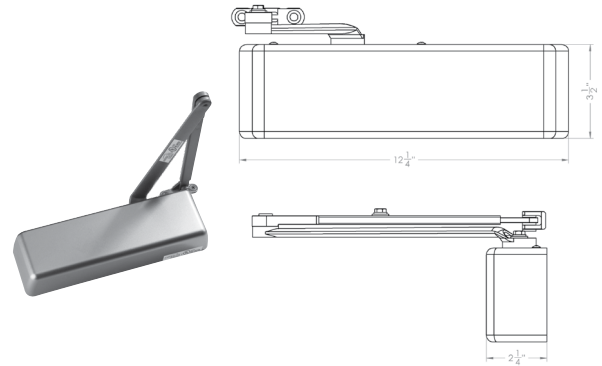

## Specifications



<b>BODY:</b>	• High Strength Cast Iron
<b>ARMS:</b>	• Forged steel main arm
<b>ARM OPTIONS:</b>	<ul style="list-style-type: none"> <li>• <b>PA</b> – Parallel Arm</li> <li>• <b>HO</b> – Hold Open</li> <li>• <b>DS/DSHO</b> – Heavy Duty Parallel Stop</li> <li>• <b>RA</b> – Regular Arm</li> <li>• <b>SCS/SCSHO</b> – Spring Cushion Stop for DS/DSHO</li> <li>• <b>TA/TAHO</b> – Track Arm</li> <li>• <b>EDA/EDAHO</b> – Extra Duty Parallel Arm</li> </ul>
<b>PISTON:</b>	• 1-1/2" diameter
<b>ADJUSTMENT:</b>	<ul style="list-style-type: none"> <li>• Hydraulic controlled closing</li> <li>• Hydraulic backcheck standard</li> <li>• Backcheck positioning valve standard (starts backcheck snubbing sooner)</li> <li>• Optional delayed action (in addition to backcheck)</li> </ul>
<b>ADJUSTMENT VALVES:</b>	• All Adjustment Valves are STAKED to prevent removal during adjustment.
<b>SIZE:</b>	• Adjustable BF through 6
<b>MOUNTING RETROFIT:</b>	<ul style="list-style-type: none"> <li>• Mounting hole pattern retrofits LCN™ 4040 • Tri-packed for regular, top jamb and parallel arm installations</li> <li>• Includes sex nuts/bolts and screws for wood/metal doors/frames</li> <li>• Self drilling self tapping screws standard</li> <li>• Separate limiting stop may be required for high abuse applications</li> </ul>
<b>COVER:</b>	• Full plastic cover standard, optional full metal cover available
<b>COLOR &amp; ARCHITECTURAL FINISHES:</b>	• 605 – Polished Brass, 625 – Polished Chrome, 689 – Aluminum, 693 – Black, 695 – Duro Bronze, 696 – Gold
<b>WARRANTY:</b>	• Twenty-five (25) year Limited Warranty
<b>CERTIFICATIONS, LISTINGS, COMPLIANCES:</b>	<ul style="list-style-type: none"> <li>• UL listed for labeled swinging fire doors rated up to and including 3 hours</li> <li>• Certified to ANSI/BHMA A156.4 Grade 1</li> <li>• Complies with ADA (Americans with Disabilities Act) and ICC/ANSI 117.1 for Accessible and Usable Buildings</li> <li>• TAA compliant. Country of origin: KR</li> </ul>

## Spring Cushion Stops



**605  
BRIGHT  
BRASS**



**613E DARK  
OXIDIZED  
SATIN BRONZE  
(EQUIVALENT)**



**630 SATIN  
STAINLESS  
STEEL**



**693 BLACK**

PDQ's SCS Series Spring Cushion Stop helps reduce wear and tear on the opening. As the door begins moving through back check to its maximum opening angle, the stop acts as a shock absorber, dampening the impact forces



# 7100 SERIES

## LIST PRICE

Effective July 3, 2023

### How to Order

QUANTITY	SERIES	DELAYED ACTION	BACKCHECK	ARM TYPE	FINISH	ACCESSORIES
10	71	<b>01</b> – Non-Delayed Action <b>41</b> – Delayed Action (In Addition To Backcheck)	<b>BC</b> – Adjustable Hydraulic Backcheck	<b>PA</b> <b>DS</b> – Door Saver Arm <b>DSHO</b> – Door Saver Hold Open Arm <b>EDA</b> – Extra Duty Arm <b>EDAHO</b> – Extra Duty Arm Hold Open <b>HO</b> – Hold Open, Tri-Pack <b>PA</b> – Tri-Pack (standard) <b>RA</b> – Regular Arm <b>SCS</b> – Spring Cushion Stop <b>SCSHO</b> – Spring Cushion Stop Hold open <b>TA</b> – Track Arm <b>TAHO</b> – Track Arm Hold Open	<b>689</b> <b>605</b> – Polished Brass <b>625</b> – Polished Chrome <b>689</b> – Aluminum <b>693</b> – Black <b>695</b> – Duro Bronze <b>696</b> – Gold	— <b>BP</b> – Back Plate <b>BS</b> – Blade Stop Spacer <b>DPPA</b> – Parallel Arm Drop Plate <b>DPTJ</b> – Top Jamb Drop Plate <b>FCM</b> – Full Metal Cover specify hand <b>NFB</b> – Narrow Frame Bracket <b>SDST</b> – Self Drilling Self Tapping Screws

PAGE 191

### Closers

PART	SIZE	DESCRIPTION	PAINTED 689/693 695/696	PLATED 605/625
<b>7101 BC PA</b>	BF-6	Closer, full cover, SNB (Tri-pack)	\$342.00	\$497.00
<b>7101 BC RA</b>	BF-6	Closer, full cover, Regular Arm, SNB		
<b>7101 BC PA HO</b>	BF-6	Closer, hold open, full cover, SNB (Tri-pack)	\$425.00	\$580.00
<b>7101 BC DS</b>	BF-6	Closer, door saver, full cover, SNB (PA Only)	\$450.00	\$605.00
<b>7101 BC DSHO</b>	BF-6	Closer, door saver hold open, full cover, SNB (PA Only)	\$475.00	\$630.00
<b>7101 BC EDA</b>	BF-6	Closer, extra duty arm, full cover, SNB (PA Only)	\$450.00	\$605.00
<b>7101 BC EDA HO</b>	BF-6	Closer, extra duty arm hold open, full cover, SNB (PA Only)	\$475.00	\$630.00
<b>7101 BC SCS</b>	BF-6	Closer, door saver w/spring cushion stop, full cover, SNB (PA Only)	\$542.00	\$697.00
<b>7101 BC SCSHO</b>	BF-6	Closer, door saver hold open w/spring cushion stop, full cover, SNB (PA Only)	\$558.00	\$713.00
<b>7101 BC TA</b>	BF-6	Closer, track arm, full cover, (SNB for closer body only)	\$445.00	-
<b>7101 BC TA HO</b>	BF-6	Closer, track arm hold open, full cover (SNB for closer body only)		

### Options

PART NO.	DESCRIPTION	CLOSER ADJUSTMENT
<b>7141</b>	Delayed Action (when ordering, replace 7101 with 7141 in part number)	\$28.00

### Accessories

CODE	DESCRIPTION	LIST PRICE		
		PAINTED 689/693/695/696	PLATED 605/625	UNFINISHED
<b>BS</b>	Blade Stop Spacer (no finish)	-	-	\$80.00
<b>BP</b>	Back Plate	\$80.00	-	-
<b>DPPA</b>	Parallel Arm Drop Plate (PA mount)		-	-
<b>DPTJ</b>	Top Jamb Drop Plate (TJ mount)		-	-
<b>BPTJ</b>	Top Jamb Back Plate - Required to mount TJ on frame face less than 4"		-	-
<b>FCM</b>	Full Metal Cover (specify hand)	\$120.00	\$170.00	-
<b>NFB</b>	Narrow Frame Bracket for DS/DSHO/EDS/EDAHO Arms, PA & BS Brackets	\$48.00	-	-
<b>SDST</b>	Self Drilling Self Tapping Screws	\$17.00	\$35.00	-

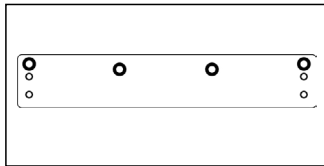

**BP - BACK PLATE**

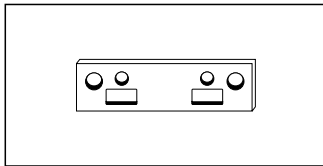

**BS - BLADE STOP SPACER**

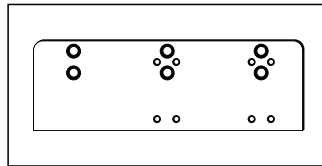

**DPTJ - TOP JAMB DROP PLATE**

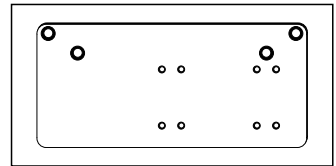

**DPPA - PARALLEL ARM DROP PLATE**

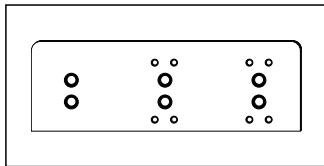

**BPTJ - TOP JAMB BACK PLATE**

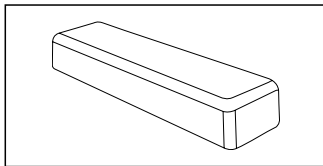

**FCM - FULL METAL COVER**

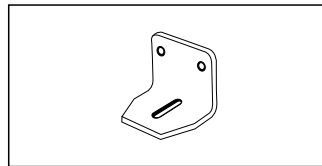

**NFB - NARROW FRAME BRACKET**

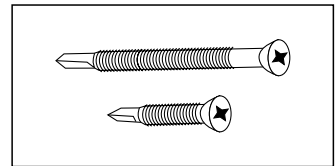

**SDST - SELF DRILLING SELF TAPPING SCREWS**

### Arms

CODE	DESCRIPTION	PART NO. (SPECIFY FINISH)	LIST PRICE	
			PAINTED 689/693/695/696	PLATED 605/625
<b>RA</b>	REGULAR ARM - Can be mounted REG/TJ/PA (requires PA bracket)	719003	\$96.00	\$171.00
<b>EDA</b>	EXTRA DUTY ARM - PA application only (bumper eliminated)	719005	\$145.00	\$220.00
<b>DS</b>	DOOR SAVER ARM (Limiting Stop) - PA application only	719005		
<b>DSHO</b>	DOOR SAVER HOLD OPEN ARM (limiting stop) PA application only	719016	\$165.00	\$240.00
<b>HO</b>	HOLD OPEN ARM - can be mounted REG/TJ/PA (requires PA bracket)	719002	\$122.00	\$197.00
<b>EDAHO</b>	EXTRA DUTY ARM HOLD OPEN - PA application only (bumper eliminated)	719016	\$165.00	\$240.00
<b>TA</b>	TRACK ARM ASSEMBLY - (Includes track, arm and screws)	719025	\$140.00	-
<b>TAHO</b>	TRACK ARM HOLD OPEN	719025		
<b>PA</b>	PARALLEL ARM BRACKET - HO and NHO	719001	\$22.00	\$97.00
<b>ELR</b>	Extended arm half to be used on Top Jamb mounts with reveals from 3" to 6"	719028	\$55.00	-

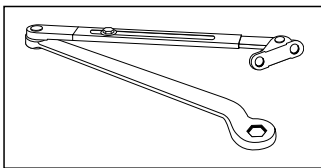

**RA** - REGULAR ARM

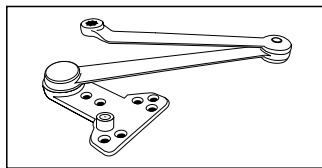

**DS** - Door Saver (Limiting Stop) Arm

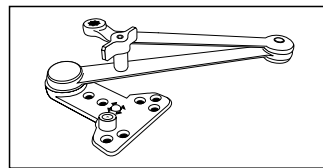

**DSHO** - DOOR SAVER (LIMITING STOP) HOLD OPEN ARM

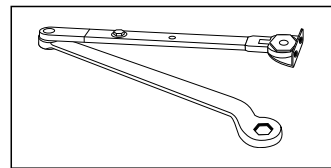

**HO** - Hold Open Arm

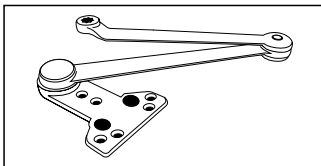

**EDA** - EXTRA DUTY ARM

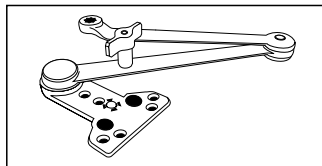

**EDAHO** - EXTRA DUTY ARM HOLD OPEN

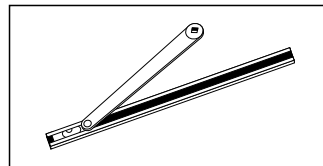

**TA** - TRACK ARM ASSEMBLY

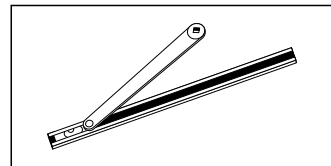

**TAHO** - TRACK ARM HOLD OPEN

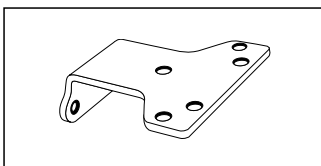

**PA** - PARALLEL ARM BRACKET

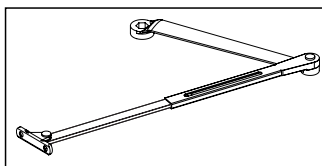

**ELR** - EXTENDED ARM



### Covers

CODE	DESCRIPTION	PART NO. (SPECIFY FINISH)	LIST PRICE	
			PAINTED 689/693/695/696	PLATED 605/625
<b>FC</b>	FULL PLASTIC COVER	719006	\$45.00	\$90.00
<b>FCM</b>	FULL METAL COVER - Optional (specify hand)	719006ST	\$120.00	\$170.00

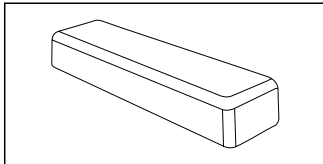

**FC** - FULL PLASTIC COVER

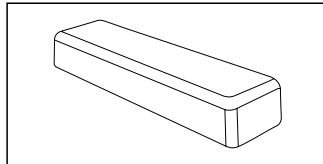

**FCM** - FULL METAL COVER

### Mounting Plates

CODE	DESCRIPTION	PART NO. (SPECIFY FINISH)	LIST PRICE
			PAINTED 689/693/695/696
<b>BP</b>	BACK PLATE - For regular arm applications to clear mortised stop/holder	719008	\$80.00
<b>BPTJ</b>	TOP JAMB BACK PLATE - Required to mount TJ on frame face less than 4"	719024	
<b>DPTJ</b>	TOP JAMB DROP PLATE - Required to mount TJ with limited ceiling clearance or to clear surface applied stop/holder	719023	
<b>DPPA</b>	PARALLEL ARM DROP PLATE - Required for parallel arm mount with limited top door rail	719018	
<b>BS*</b>	BLADE STOP SPACER - Shims all PA brackets to clear 1/2" blade stop (no finish)	999026	
<b>NFB</b>	NARROW FRAME BRACKET - For DS/DSHO/EDS/EDAHO arms, PA and BS brackets for added reinforcement (no finish)	999011	\$48.00

\*Note: When using a Blade Stop Spacer in a narrow frame application you must use the (NFB) Narrow Frame Bracket for proper support.

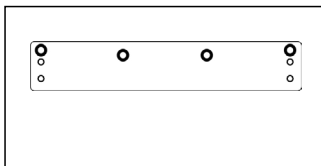

**BP** - BACK PLATE

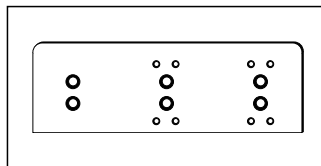

**BPTJ** - TOP JAMB BACK PLATE

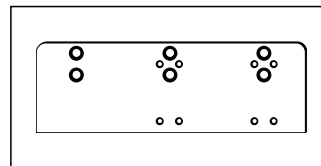

**DPTJ** - TOP JAMB DROP PLATE

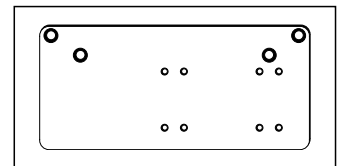

**DPPA** - PARALLEL ARM DROP PLATE

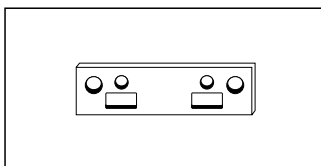

**BS** - BLADE STOP SPACER

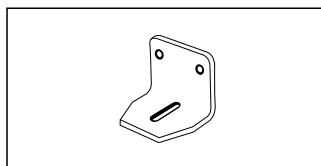

**NFB** - NARROW FRAME BRACKET

# 7100 SERIES

## LIST PRICE

Effective July 3, 2023

### Fasteners

CODE	DESCRIPTION	PART NO. (SPECIFY FINISH)	LIST PRICE	
			PAINTED 689/693/695/696	PLATED 605/625
SDST	SELF DRILLING SELF TAPPING SCREWS	719007	\$17.00	\$35.00
SP	SCREW PACK	719020		
SNB	SEX NUTS AND BOLTS -For through bolting on unreinforced hollow core, composite or labeled fire doors 1-3/4" only. (set of 4 each)	999004		
TSP	Tamper resistant screw pack	*719042	\$90.00	

\*No finish

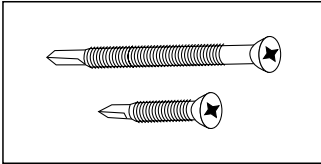

**SDST** - SELF DRILLING SELF TAPPING SCREWS

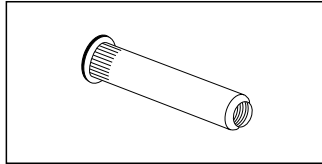

**SNB** - SEX NUTS AND BOLTS

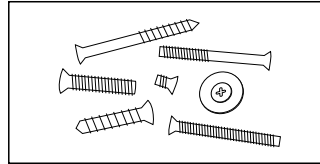

**SP** - SCREW PACK

### Parts

CODE	DESCRIPTION	PART NO. (SPECIFY FINISH)	LIST PRICE	
			PAINTED 689/693 695/696	PLATED 605/625
DSBS	DOOR SAVER BUMPER STOP - (no finish) Used on DS, DSHO, PS arms	999010	\$22.00	
SPBL	PLASTIC SPACER BLOCK - For DS/DSHO/EDA/EDAHO and PA soffit brackets (no finish)	999031	\$10.00	
SCS	SPRING CUSHION STOP* - USE with DS/DSHO for 3'0" doors (specify finish), for PA mount arms only	999032	\$150.00	
SCS	SPRING CUSHION STOP* - For DS/DSHO for 4'0" doors, (specify finish), for PA mount arms only	999033		

\* Spring Cushion Stop requires purchase of a PDQ DS or DSHO arm.

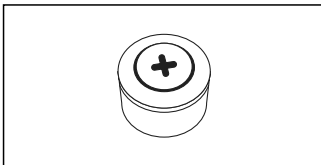

**DSBS** - DOOR SAVER BUMPER STOP

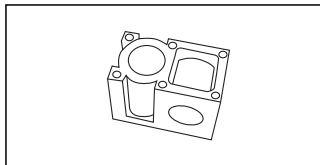

**SPBL** - PLASTIC SPACER BLOCK

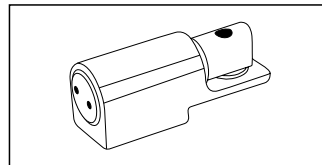

**SCS** - SPRING CUSHION STOP

### Spring Cushion Stop (SCS) Finish Match to Closers

SCS FINISH	CLOSER FINISH
605 (PVD)	605/696
613E (PVD)	695
630	625/626/689
693	693

# 5100 SERIES

# Grade 1 Institutional Closer

## Typical Applications

- Aluminum Storefronts
- Assisted Living
- Government Facilities
- Higher Education
- Hospitality
- Houses of Worship
- Interior Office Doors
- Multi-family
- Offices
- Retail

## Features

- Features a 1-1/2" (38 mm) diameter hardened steel pinion
- Fully featured architectural style door control
- Full cover and flat design arm assembly provide both durability and aesthetically pleasing appearance in commercial and institutional applications
- The closer is ideally suited for installation on wood or metal doors and frames.
- The units are non-handed and fully adjustable from size one through six for maximum flexibility.
- The standard tri-pack feature provides versatility to permit regular, top-jamb and parallel arm installations.
- A range of sprayed and architectural finishes are available to compliment any décor.
- Maximum 4" reveal for Top Jamb.

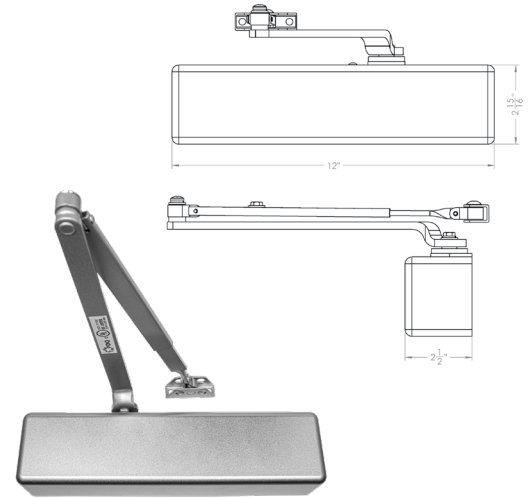

## Specifications



<b>BODY:</b>	• High Strength Aluminum Alloy Body
<b>ARM OPTIONS:</b>	<ul style="list-style-type: none"> <li>• <b>PA</b> – Parallel Arm</li> <li>• <b>HO</b> – Hold Open</li> <li>• <b>DS/DSHO</b> – Heavy Duty Parallel Arm Stop</li> <li>• <b>RA</b> – Regular Arm</li> <li>• <b>SCS/SCSHO</b> – Heavy Duty Parallel Arm Cushion Stop</li> <li>• <b>TA/TAHO</b> – Track Arm</li> <li>• <b>EDA/EDAHO</b> – Extra Duty Parallel Arm</li> <li>• <b>PS</b> – Pivot Stop Arm*</li> </ul>
<b>PINION:</b>	• Hardened steel, 1-1/2" diameter
<b>ADJUSTMENT:</b>	• Hydraulic controlled closing    • Separate hydraulic backcheck standard    • Optional delayed action (in addition to backcheck)
<b>SIZE:</b>	• Adjustable 1 through 6
<b>MOUNTING:</b>	<ul style="list-style-type: none"> <li>• Tri-packed for regular, top jamb and parallel arm installations</li> <li>• Includes sex nuts/bolts and screws for wood/metal doors/frames</li> <li>• Self drilling, self tapping screws standard</li> <li>• Separate limiting stop may be required for high abuse application</li> </ul>
<b>COVER:</b>	• Full plastic cover standard, optional full metal cover available
<b>COLOR &amp; ARCHITECTURAL FINISHES:</b>	• 605 – Polished Brass, 626 – Satin Chrome, 689 – Aluminum, 693 – Black, 695 – Duro Bronze, 696 – Gold
<b>WARRANTY:</b>	• Twenty-five (25) year Limited Warranty
<b>CERTIFICATIONS, LISTINGS, COMPLIANCES:</b>	<ul style="list-style-type: none"> <li>• UL listed for labeled swinging fire doors rated up to and including 3 hours</li> <li>• Certified to ANSI/BHMA A156.4 Grade 1</li> <li>• TAA compliant. Country of origin: KR</li> </ul>

# 5100 SERIES

## LIST PRICE

Effective July 3, 2023

### How to Order

5100 SERIES  
DOOR CLOSERS

QUANTITY	SERIES	DELAYED ACTION	BACKCHECK	ARM TYPE	FINISH	ACCESSORIES
10	51	01	BC	PA	689	—
<b>NOTES</b> <b>1 - Hold Open (HO) option not permitted for use on labeled fire doors.</b> <b>2 - Separate limiting stop may be required.</b>		<b>01</b> – Non-Delayed Action  <b>41</b> – Delayed Action (In Addition To Backcheck)	<b>BC</b> – Adjustable Hydraulic Backcheck	<b>DS</b> – Door Saver Arm <b>DSHO</b> – Door Saver Hold Open Arm <b>EDA</b> – Extra Duty Arm <b>EDA HO</b> – Extra Duty Arm Hold Open <b>HO</b> – Hold Open, Tri-Pack <b>PA</b> – Tri-Pack (standard) <b>RA</b> – Regular Arm <b>SCS</b> – Spring Cushion Stop <b>SCSHO</b> – Spring Cushion Stop Hold open <b>TA</b> – Track Arm <b>TAHO</b> – Track Arm Hold Open <b>PS</b> – Pivot Stop Arm	<b>605</b> – Polished Brass <b>626</b> – Satin Chrome <b>689</b> – Aluminum <b>693</b> – Black <b>695</b> – Duro Bronze <b>696</b> – Gold	<b>BP</b> – Back Plate <b>BS</b> – Blade Stop Spacer <b>DPPA</b> – Parallel Arm Drop Plate <b>DPTJ</b> – Top Jamb Drop Plate <b>FCM</b> – Full Metal Cover specify hand <b>NFB</b> – Narrow Frame Bracket <b>SDST</b> – Self Drilling Self Tapping Screws

PAGE 197

### Closers

PART	DESCRIPTION	PAINTED 689/693 695/696	PLATED 605/626
<b>5101 BC PA</b>	Closer, 1-6, full cover, SNB (Tri-pack)	\$262.00	\$362.00
<b>5101 BC RA</b>	Closer, 1-6, full cover, regular arm, SNB		
<b>5101 BC PA HO</b>	Closer, 1-6, hold open, full cover, SNB (Tri-pack)	\$342.00	\$442.00
<b>5101 BC DS</b>	Closer, 1-6, door saver, full cover, SNB (PA only)	\$367.00	\$467.00
<b>5101 BC DSHO</b>	Closer, 1-6, door saver hold open, full cover, SNB (PA only)	\$397.00	\$497.00
<b>5101 BC EDA</b>	Closer, 1-6, extra duty arm, full cover, SNB (PA only)	\$367.00	\$467.00
<b>5101 BC EDA HO</b>	Closer, 1-6, extra duty arm hold open, full cover, SNB (PA only)	\$397.00	\$497.00
<b>5101 BC SCS</b>	Closer, 1-6, door saver w/spring cushion stop, full cover, SNB (PA only)	\$462.00	\$562.00
<b>5101 BC SCSHO</b>	Closer, 1-6, door saver hold open w/spring cushion stop, full cover, SNB (PA only)	\$467.00	\$567.00
<b>5101 BC TA</b>	Closer, 1-6, track arm, full cover (SNB for closer body only)	\$342.00	-
<b>5101 BC TAHO</b>	Closer, 1-6, track arm hold open, full cover (SNB for closer body only)		
<b>5101 BC PS</b>	Closer, 1-6, pivot stop, full cover (SNB for closer body only)	\$412.00	-

### Options

PART NO.	DESCRIPTION	CLOSER ADJUSTMENT
5141	Delayed Action (when ordering, replace 5101 with 5141 in part number)	\$28.00

### Accessories

CODE	DESCRIPTION	LIST PRICE		
		PAINTED 689/693/695/696	PLATED 605/626	UNFINISHED
BS	Blade Stop Spacer (no finish)	-	-	\$80.00
BP	Back Plate	\$80.00	-	-
DPPA	Parallel Arm Drop Plate (5500 only)	\$80.00	-	-
DPTJ	Top Jamb Drop Plate	\$80.00	-	-
NFB	Parallel Arm NHO Bracket	\$48.00	-	-
SDST	Self Drilling Self Tapping Screws	\$17.00	\$35.00	-

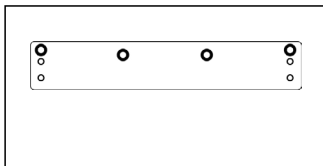

BP - BACK PLATE

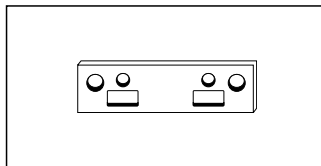

BS - BLADE STOP SPACER

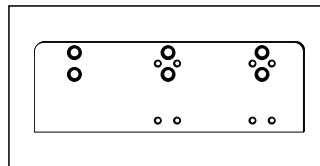

DPTJ - TOP JAMB DROP PLATE

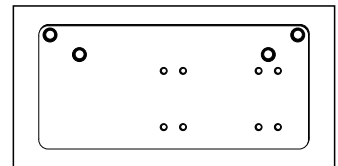

DPPA - PARALLEL ARM DROP PLATE

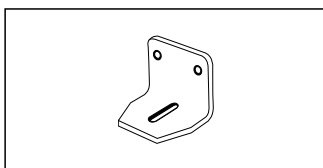

NFB - NARROW FRAME BRACKET

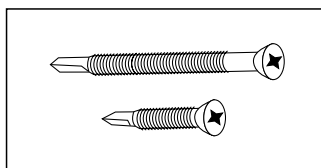

SDST - SELF DRILLING SELF TAPPING SCREWS

### Spring Cushion Stops



605  
BRIGHT  
BRASS



613E DARK  
OXIDIZED  
SATIN BRONZE  
(EQUIVALENT)



630 SATIN  
STAINLESS  
STEEL



693 BLACK

PDQ's SCS Series Spring Cushion Stop helps reduce wear and tear on the opening. As the door begins moving through back check to its maximum opening angle, the stop acts as a shock absorber, dampening the impact forces

### Arms

CODE	DESCRIPTION	PART NO. (SPECIFY FINISH)	LIST PRICE	
			PAINTED 689/693/695/696	PLATED 605/626
<b>RA</b>	REGULAR ARM - Can be mounted REG/TJ/PA (requires PA bracket)	999003	\$80.00	\$130.00
<b>EDA</b>	EXTRA DUTY ARM - PA application only (bumper eliminated)	999005	\$160.00	\$210.00
<b>DS</b>	DOOR SAVER ARM (Limiting Stop) - PA application only	999005		
<b>DSHO</b>	DOOR SAVER HOLD OPEN ARM (limiting stop) PA application only	999016	\$194.00	\$244.00
<b>HO</b>	HOLD OPEN ARM - can be mounted REG/TJ/PA (requires PA bracket)	999002	\$122.00	\$172.00
<b>EDAHO</b>	EXTRA DUTY ARM HOLD OPEN - PA application only (bumper eliminated)	999016	\$194.00	\$244.00
<b>TA</b>	TRACK ARM ASSEMBLY - (Includes track, arm and screws)	999025	\$145.00	-
<b>TAHO</b>	TRACK ARM HOLD OPEN	999025		
<b>PA</b>	PARALLEL ARM BRACKET - NON HOLD OPEN applications	999001	\$22.00	\$72.00
<b>PAHO</b>	PARALLEL ARM BRACKET - HOLD OPEN applications	999022	\$33.00	
<b>PS</b>	PIVOT STOP ARM - Regular and Top Jamb Only	999018	\$184.00	

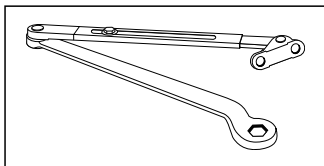

**RA** - REGULAR ARM

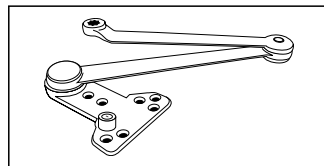

**DS** - DOOR SAVER (LIMITING STOP) ARM

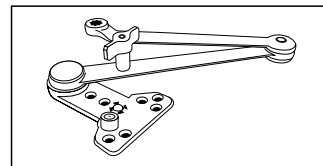

**DSHO** - DOOR SAVER (LIMITING STOP) HOLD OPEN ARM

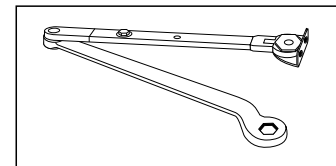

**HO** - HOLD OPEN ARM

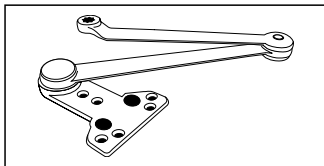

**EDA** - EXTRA DUTY ARM

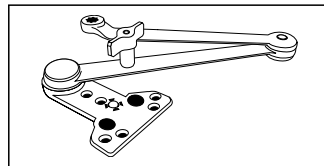

**EDAHO** - EXTRA DUTY ARM HOLD OPEN

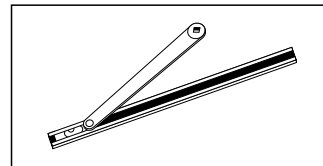

**TA** - TRACK ARM ASSEMBLY

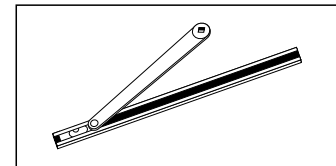

**TAHO** - TRACK ARM HOLD OPEN

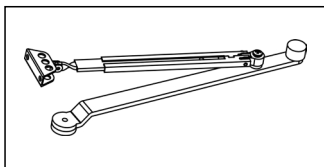

**PS** - PIVOT STOP ARM

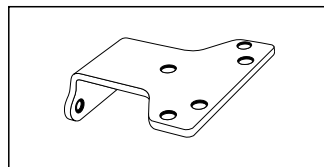

**PA** - PARALLEL ARM BRACKET

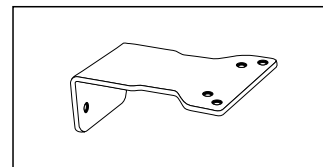

**PAHO** - PARALLEL ARM HO BRACKET

### Covers

CODE	DESCRIPTION	PART NO. (SPECIFY FINISH)	LIST PRICE	
			PAINTED 689/693/695/696	PLATED 605/626
<b>FC</b>	FULL PLASTIC COVER	559006	\$45.00	\$90.00
<b>FMC</b>	FULL METAL COVER	519006ST	\$100.00	-

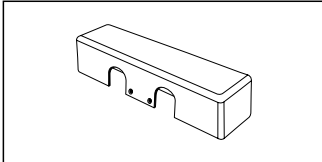

**FC** - FULL PLASTIC COVER-5500  
(STANDARD)

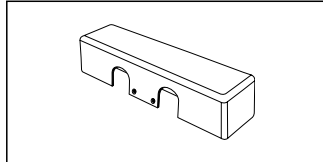

**FMC** - FULL METAL COVER  
(OPTIONAL)

### Mounting Plates

CODE	DESCRIPTION	PART NO. (SPECIFY FINISH)	LIST PRICE
			PAINTED 689/693/695/696
<b>BP</b>	BACK PLATE - For regular arm applications to clear mortised stop/holder	519008	\$80.00
<b>DPTJ</b>	TOP JAMB DROP PLATE - Required to mount TJ with limited ceiling clearance or to clear surface applied stop/holder	519023	
<b>DPPA</b>	PARALLEL ARM DROP PLATE - Required for parallel arm mount with limited top door rail	519018	
<b>BS*</b>	BLADE STOP SPACER - Shims all PA brackets to clear 1/2" blade stop (no finish)	999026	
<b>NFB</b>	NARROW FRAME BRACKET - For DS/DSHO/EDS/EDAHO arms, PA and BS brackets for added reinforcement (no finish)	999011	\$48.00

\*Note: When using a Blade Stop Spacer in a narrow frame application you must use the (NFB) Narrow Frame Bracket for proper support.

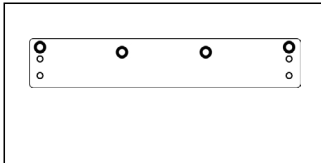

**BP** - BACK PLATE

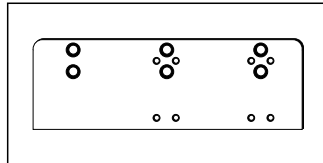

**DPTJ** - TOP JAMB DROP PLATE

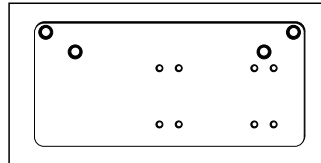

**DPPA** - PARALLEL ARM DROP  
PLATE

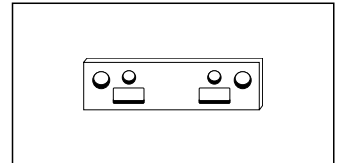

**BS** - BLADE STOP SPACER

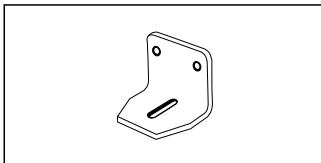

**NFB** - NARROW FRAME BRACKET

# 5100 SERIES

## LIST PRICE

Effective July 3, 2023

### Fasteners

5100 SERIES  
DOOR CLOSERS

CODE	DESCRIPTION	PART NO. (SPECIFY FINISH)	LIST PRICE	
			PAINTED 689/693/695/696	PLATED 605/626
SDST	SELF DRILLING SELF TAPPING SCREWS	999007	\$17.00	\$35.00
SP	SCREW PACK	999020		
SNB	SEX NUTS AND BOLTS -For through bolting on unreinforced hollow core, composite or labeled fire doors 1-3/4" only. (set of 4 each)	999004		

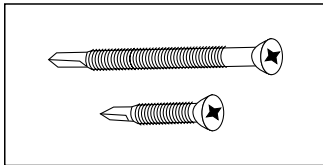

**SDST** - SELF DRILLING SELF TAPPING SCREWS

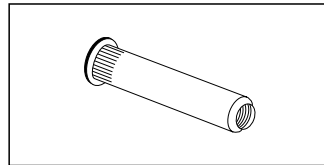

**SNB** - SEX NUTS AND BOLTS

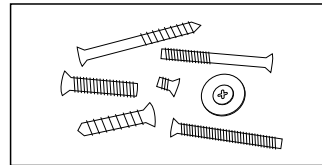

**SP** - SCREW PACK

### Parts

CODE	DESCRIPTION	PART NO. (SPECIFY FINISH)	LIST PRICE	
			PAINTED 689/693 695/696	PLATED 605/626
DSBS	DOOR SAVER BUMPER STOP - (no finish) Used on DS, DSHO, PS Arms	999010	\$22.00	
SPBL	PLASTIC SPACER BLOCK - For DS/DSHO/EDA/EDAHO and PA soffit brackets (no finish)	999031	\$10.00	
SCS	SPRING CUSHION STOP* - USE with DS/DSHO for 3'0" doors (specify finish), for PA mount arms only	999032	\$150.00	
SCS	SPRING CUSHION STOP* - For DS/DSHO for 4'0" doors, (specify finish), for PA mount arms only	999033		

\* Spring Cushion Stop requires purchase of a PDQ DS or DSHO arm.

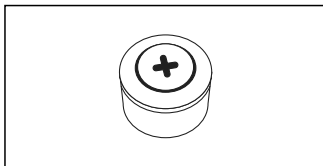

**DSBS** - DOOR SAVER BUMPER STOP

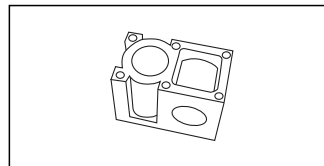

**SPBL** - PLASTIC SPACER BLOCK

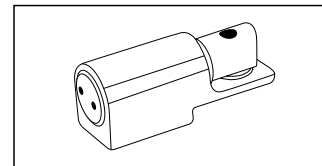

**SCS** - SPRING CUSHION STOP

### Spring Cushion Stop (SCS) Finish Match to Closers

SCS FINISH	CLOSER FINISH
605 (PVD)	605/696
613E (PVD)	695
630	626/689
693	693



# 5300 Slim Cover 5500 Full Cover SERIES

# Grade 1 Commercial Closer

## Typical Applications

- Assisted Living
- Exterior Doors in Heavy Draft/Wind Conditions
- Government Facilities
- Healthcare
- Higher Education
- Hospitality
- Houses of Worship
- Industrial
- K-12 Education
- Offices
- Retail

## Features

- Heavy duty, fully featured architectural style door control
- Available with modern streamline cover or full sized cover
- Compact appearance and features meet the demands of institutional and commercial applications
- The standard tri-pack, full range spring adjustment and common 12" x 3/4" mounting hole pattern make the 5300/5500 ideally suited for stocking distributors and retrofit applications
- Adjustable hydraulic backcheck prevents damage for uncontrolled door opening
- Perfect solution for a variety of applications requiring streamline architectural grade door controls
- Maximum 4" reveal for Top Jamb.

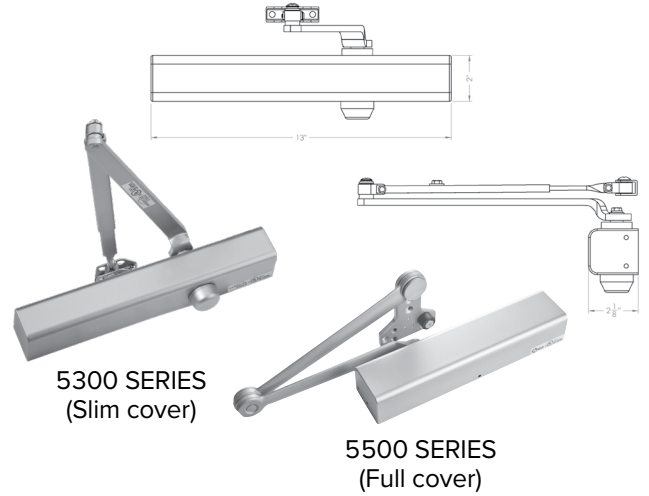

5300 SERIES  
(Slim cover)

5500 SERIES  
(Full cover)

## Specifications



<b>BODY:</b>	• Cast High Strength Aluminum Alloy Body
<b>ARM OPTIONS:</b>	<ul style="list-style-type: none"> <li>• <b>PA</b> – Parallel Arm</li> <li>• <b>HO</b> – Hold Open</li> <li>• <b>DS/DSHO</b> – Heavy Duty Parallel Arm Stop</li> <li>• <b>RA</b> – Regular Arm</li> <li>• <b>SCS/SCSHO</b> – Heavy Duty Parallel Arm Cushion Stop</li> <li>• <b>TA/TAHO</b> – Track Arm</li> <li>• <b>EDA/EDAHO</b> – Extra Duty Parallel Arm</li> <li>• <b>PS</b> – Pivot Stop Arm*</li> </ul>
<b>ADJUSTMENT:</b>	<ul style="list-style-type: none"> <li>• Hydraulic controlled closing</li> <li>• Separate hydraulic backcheck standard</li> <li>• Optional adjustable delayed action (In addition to backcheck)</li> </ul>
<b>RETROFIT:</b>	• Common 12" x 3/4" mounting hole pattern retrofits Norton 8300/8500* and Yale 3300/3500
<b>SIZE:</b>	• Adjustable • BF through 6
<b>MOUNTING:</b>	<ul style="list-style-type: none"> <li>• Includes sex nuts/bolts and screws for wood/metal doors/frames</li> <li>• Tri-packed for regular, top jamb and parallel arm installations</li> <li>• Separate limiting stop may be required for high abuse applications</li> <li>• Self drilling, self tapping screws standard</li> </ul>
<b>COVER:</b>	• 5300 Series - Streamline plastic cover (non-handed) 5500 Series - Full plastic cover standard (field reversible)
<b>COLOR &amp; ARCHITECTURAL FINISHES:</b>	• 605 – Polished Brass, 625 – Polished Chrome, 689 – Aluminum, 693 – Black, 695 – Duro Bronze, 696 – Gold
<b>WARRANTY:</b>	• Twenty-five (25) year Limited Warranty
<b>CERTIFICATIONS, LISTINGS, COMPLIANCES:</b>	<ul style="list-style-type: none"> <li>• UL listed for labeled swinging fire doors rated up to and including 3 hours</li> <li>• Certified to ANSI/BHMA A156.4 Grade 1</li> <li>• Complies with ADA (Americans with Disabilities Act) and ICC/ANSI 117.1 for Accessible and Usable Buildings</li> <li>• TAA compliant. Country of origin: KR</li> </ul>

# 5300/5500 SERIES

## LIST PRICE

Effective July 3, 2023

### How to Order

QUANTITY	SERIES	DELAYED ACTION	BACKCHECK	ARM TYPE	FINISH	ACCESSORIES
10	53	01	BC	PA	689	—
	53 – Slim Cover 55 – Full Cover	01 – Non-Delayed Action 41 – Delayed Action (In Addition to Backcheck)	BC – Adjustable Hydraulic Backcheck	DS – Door Saver Arm DSHO – Door Saver Hold Open Arm EDA – Extra Duty Arm EDAHO – Extra Duty Arm Hold Open HO – Hold Open, Tri-Pack PA – Tri-Pack (standard) RA – Regular Arm SCS – Spring Cushion Stop SCSHO – Spring Cushion Stop Hold open TA – Track Arm TAHO – Track Arm Hold Open PS – Pivot Stop Arm	605 – Polished Brass 625 – Polished Chrome 689 – Aluminum 693 – Black 695 – Duro Bronze 696 – Gold	BP – Back Plate BS – Blade Stop Spacer DPPA – Parallel Arm Drop Plate DPTJ – Top Jamb Drop Plate NFB – Narrow Frame Bracket
						PAGE 202

**5300/5500 SERIES**  
 DOOR CLOSERS

### Closers

PART	DESCRIPTION	PAINTED 689/693 695/696	PLATED 605/625
5300 SERIES			
5301 BC PA	Closer, BF-6, streamline cover, SNB (Tri-pack)	\$240.00	\$340.00
5301 BC RA	Closer, BF-6, regular arm, streamline cover, SNB		
5301 BC PA HO	Closer, BF-6, hold open, streamline cover, SNB (Tri-pack)	\$320.00	\$420.00
5301 BC DS	Closer, BF-6, door saver, streamline cover, SNB (PA only)	\$345.00	\$445.00
5301 BC DSHO	Closer, BF-6, door saver hold open, streamline cover, SNB (PA only)	\$375.00	\$475.00
5301 BC EDA	Closer, BF-6, extra duty arm, streamline cover, SNB (PA only)	\$345.00	\$445.00
5301 BC EDAHO	Closer, BF-6, extra duty hold open, streamline cover, SNB (PA only)	\$375.00	\$475.00
5301 BC SCS	Closer, BF-6, door saver w/spring cushion stop, streamline cover, SNB (PA only)	\$440.00	\$540.00
5301 BC SCSHO	Closer, BF-6, door saver hold open w/spring cushion stop, streamline cover, SNB (PA only)	\$445.00	\$545.00
5301 BC TA	Closer, BF-6, track arm, streamline cover (SNB for closer body only)	\$320.00	-
5301 BC TAHO	Closer, BF-6, track arm hold open, streamline cover (SNB for closer body only)		
5301 BC PS	Closer, BF-6, pivot stop, streamline cover (SNB for closer body only)	\$390.00	-
5500 SERIES			
5501 BC PA	Closer, BF-6, full cover, SNB (Tri-pack)	\$240.00	\$340.00
5501 BC RA	Closer, BF-6, regular arm, streamline cover, SNB		
5501 BC PA HO	Closer, BF-6, hold open, full cover, SNB (Tri-pack)	\$320.00	\$420.00
5501 BC DS	Closer, BF-6, door saver, full cover, SNB (PA only)	\$345.00	\$445.00
5501 BC DSHO	Closer, BF-6, door saver hold open, full cover, SNB (PA only)	\$375.00	\$475.00
5501 BC EDA	Closer, BF-6, extra duty arm, full cover, SNB (PA only)	\$345.00	\$445.00
5501 BC EDAHO	Closer, BF-6, extra duty arm hold open, full cover, SNB (PA only)	\$375.00	\$475.00
5501 BC SCS	Closer, BF-6, door saver w/spring cushion stop, full cover, SNB (PA only)	\$440.00	\$540.00
5501 BC SCSHO	Closer, BF-6, door saver hold open w/spring cushion stop, full cover, SNB (PA only)	\$445.00	\$545.00
5501 BC TA	Closer, BF-6, track arm, streamline cover (SNB for closer body only)	\$320.00	-
5501 BC TAHO	Closer, BF-6, rack arm hold open, streamline cover (SNB for closer body only)		
5501 BC PS	Closer, BF-6, pivot stop, full cover (SNB for closer body only)	\$390.00	-

5300/5500  
SERIES  
DOOR CLOSERS

### Options

CODE	DESCRIPTION	CLOSER ADJUSTMENT
5341	Delayed Action 5300 Series (when ordering, replace 5301 with 5341 in part number)	\$28.00
5541	Delayed Action 5500 Series (when ordering, replace 5501 with 5541 in part number)	

### Accessories

CODE	DESCRIPTION	LIST PRICE		
		PAINTED 689/693/695/696	PLATED 605/625	UNFINISHED
<b>BS</b>	Blade Stop Spacer (no finish)	-	-	\$80.00
<b>BP</b>	Back Plate	\$80.00	-	-
<b>DPPA</b>	Parallel Arm Drop Plate (5500 only)		-	-
<b>DPTJ</b>	Top Jamb Drop Plate (and PA Drop for 5300 only)		-	-
<b>NFB</b>	Parallel Arm NHO Bracket	\$48.00	-	-
<b>SDST</b>	Self Drilling Self Tapping Screws	\$17.00	\$35.00	-

5300/5500 SERIES DOOR CLOSERS

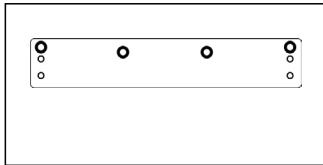

**BP - BACK PLATE**

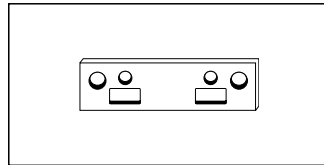

**BS - BLADE STOP SPACER**

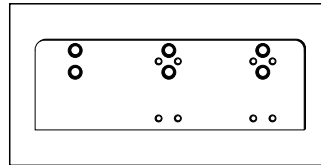

**DPTJ - TOP JAMB DROP PLATE**

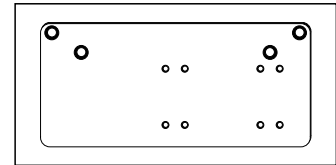

**DPPA - PARALLEL ARM DROP PLATE**

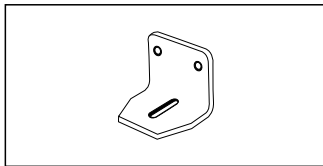

**NFB - NARROW FRAME BRACKET**

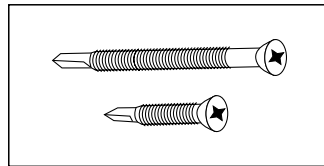

**SDST - SELF DRILLING SELF TAPPING SCREWS**

### Spring Cushion Stops



**605 BRIGHT BRASS**



**613E DARK OXIDIZED SATIN BRONZE (EQUIVALENT)**



**630 SATIN STAINLESS STEEL**



**693 BLACK**

PDQ's SCS Series Spring Cushion Stop helps reduce wear and tear on the opening. As the door begins moving through back check to its maximum opening angle, the stop acts as a shock absorber, dampening the impact forces — See page 223

### Arms

CODE	DESCRIPTION	PART NO. (SPECIFY FINISH)	LIST PRICE	
			PAINTED 689/693/695/696	PLATED 605/625
RA	REGULAR ARM - Can be mounted REG/TJ/PA (requires PA bracket)	999003	\$80.00	\$130.00
EDA	EXTRA DUTY ARM - PA application only (bumper eliminated)	999005	\$160.00	\$210.00
DS	DOOR SAVER ARM (Limiting Stop) - PA application only	999005		
DSHO	DOOR SAVER HOLD OPEN ARM (limiting stop) PA application only	999016	\$194.00	\$244.00
EDAHO	EXTRA DUTY ARM HOLD OPEN - PA application only (bumper eliminated)	999016	\$122.00	\$172.00
HO	HOLD OPEN ARM - can be mounted REG/TJ/PA (requires PA bracket)	999002	\$194.00	\$244.00
TA	TRACK ARM ASSEMBLY - (Includes track, arm and screws)	999025	\$145.00	-
TAHO	TRACK ARM HOLD OPEN	999025		
PA	PARALLEL ARM BRACKET - NON HOLD OPEN applications	999001	\$22.00	\$72.00
PAHO	PARALLEL ARM BRACKET- HOLD OPEN applications	999022	\$33.00	-
PS	PIVOT STOP ARM - Regular and Top Jamb Only	999018	\$184.00	-

5300/5500  
SERIES  
DOOR CLOSERS

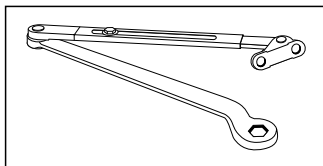

RA - REGULAR ARM

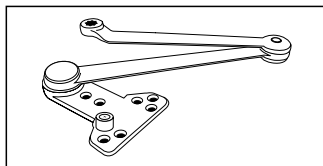

DS - DOOR SAVER (LIMITING STOP) ARM

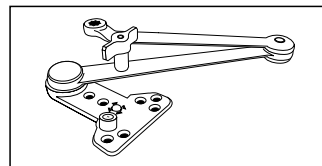

DSHO - DOOR SAVER (LIMITING STOP) HOLD OPEN ARM

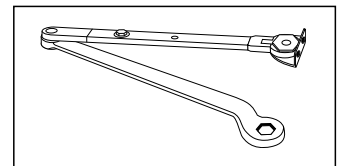

HO - HOLD OPEN ARM

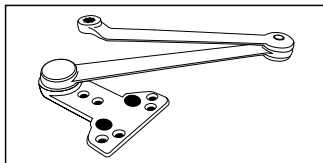

EDA - EXTRA DUTY ARM

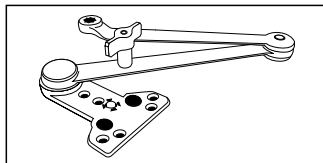

EDAHO - EXTRA DUTY ARM HOLD OPEN

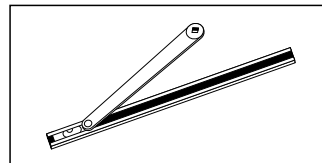

TA - TRACK ARM ASSEMBLY

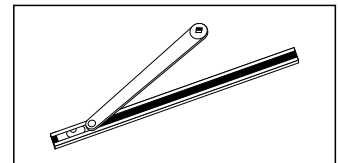

TAHO - TRACK ARM HOLD OPEN

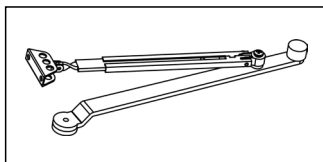

PS - PIVOT STOP ARM

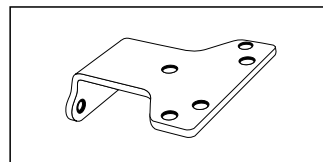

PA - PARALLEL ARM BRACKET

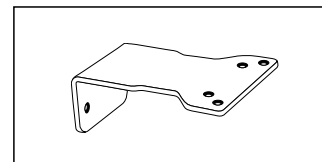

PAHO - PARALLEL ARM HO BRACKET

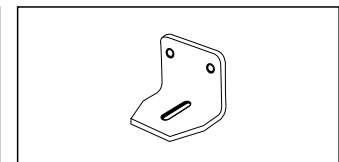

NFB - NARROW FRAME BRACKET

### Covers

CODE	DESCRIPTION	PART NO. (SPECIFY FINISH)	LIST PRICE	
			PAINTED 689/693/695/696	PLATED 605/625
<b>FC</b>	5500 SERIES FULL PLASTIC COVER (field reversible)	559006	\$45.00	\$90.00
<b>SV</b>	5300 SERIES STREAMLINE PLASTIC COVER (non-handed)	539006		

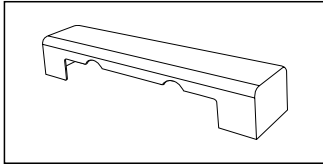

**FC** - FULL PLASTIC COVER (5500)

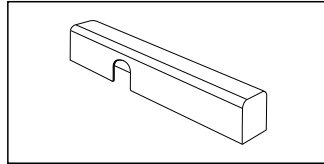

**SV** - STREAMLINE PLASTIC COVER (5300)

### Mounting Plates

CODE	DESCRIPTION	PART NO. (SPECIFY FINISH)	LIST PRICE
			PAINTED 689/693/695/696
<b>BP</b>	BACK PLATE - For regular arm applications to clear mortised stop/holder	539008/559008	\$80.00
<b>DPTJ</b>	TOP JAMB DROP PLATE - Required to mount TJ with limited ceiling clearance or to clear surface applied stop/holder	999023	
<b>DPPA</b>	PARALLEL ARM DROP PLATE - Required for parallel arm mount with limited top door rail	559018	
<b>BS*</b>	BLADE STOP SPACER - Shims all PA brackets to clear 1/2" blade stop (no finish)	999026	
<b>NFB</b>	NARROW FRAME BRACKET - For DS/DSHO/EDS/EDAHO arms, PA and BS brackets for added reinforcement (no finish)	999011	\$48.00

\*Note: When using a Blade Stop Spacer in a narrow frame application you must use the (NFB) Narrow Frame Bracket for proper support.

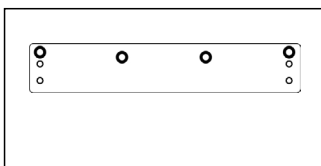

**BP** - BACK PLATE  
(539008/559008)

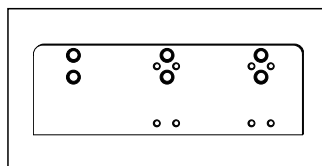

**DPTJ** - TOP JAMB DROP PLATE

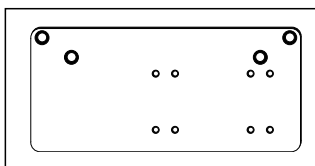

**DPPA** - PARALLEL ARM DROP PLATE

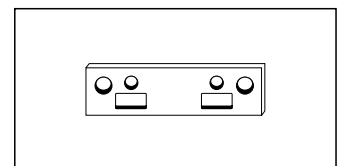

**BS** - BLADE STOP SPACER

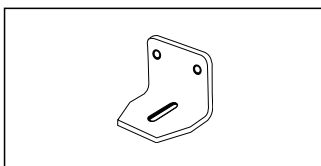

**NFB** - NARROW FRAME BRACKET

## Fasteners

CODE	DESCRIPTION	PART NO. (SPECIFY FINISH)	LIST PRICE	
			PAINTED 689/693/695/696	PLATED 605/625
<b>SDST</b>	SELF DRILLING SELF TAPPING SCREWS	999007	\$17.00	\$35.00
<b>SP</b>	SCREW PACK	999020		
<b>SNB</b>	SEX NUTS AND BOLTS -For through bolting on unreinforced hollow core, composite or labeled fire doors 1-3/4" only. (set of 4 each)	999004		

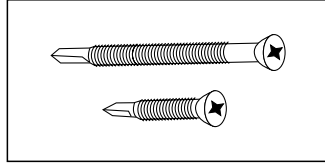

**SDST** - SELF DRILLING SELF TAPPING SCREWS

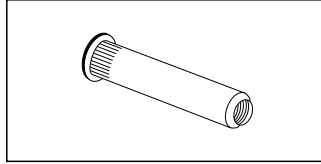

**SNB** - SEX NUTS AND BOLTS

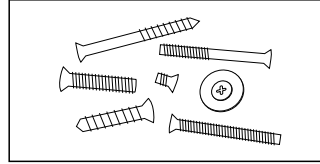

**SP** - SCREW PACK

5300/5500 SERIES DOOR CLOSERS

## Parts

CODE	DESCRIPTION	PART NO. (SPECIFY FINISH)	LIST PRICE	
			PAINTED 689/693 695/696	PLATED 605/625
<b>DSBS</b>	DOOR SAVER BUMPER STOP - (no finish) Used on DS, DSHO, PS arms	999010	\$22.00	-
<b>SPBL</b>	PLASTIC SPACER BLOCK - For DS/DSHO/EDA/EDAHO and PA soffit brackets (no finish)	999031	\$10.00	
<b>SCS</b>	SPRING CUSHION STOP* - USE with DS/DSHO for 3'0" doors (specify finish), for PA mount arms only	999032	\$150.00	
<b>SCS</b>	SPRING CUSHION STOP* - For DS/DSHO for 4'0" doors, (specify finish), for PA mount arms only	999033		

\* Spring Cushion Stop Function requires purchase of a PDQ DS or DSHO arm.

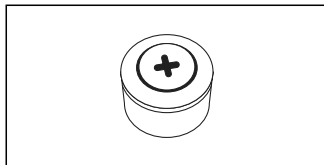

**DSBS** - DOOR SAVER BUMPER STOP

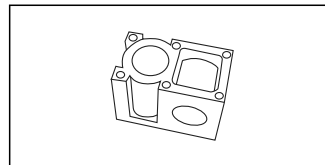

**SPBL** - PLASTIC SPACER BLOCK

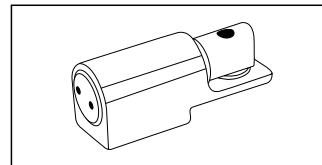

**SCS** - SPRING CUSHION STOP

SCS FINISH	CLOSER FINISH
605 (PVD)	605/696
613E (PVD)	695
630	625/626/689
693	693

# 3100 SERIES

# Grade 1 Light Commercial Closer

## Typical Applications

- Aluminum Storefronts
- Assisted Living
- Hospitality
- Interior Offices
- Multi-family

## Features

- Traditional door style door control for use in commercial door applications
- Fasteners are provided to facilitate installation on wood, hollow metal and aluminum doors and frames
- The closers are non-handed and tri-packed for maximum versatility to permit regular, top-jamb and parallel arm installations
- The common 9-1/16" mounting hole pattern permits simple installation on new and retrofit applications.
- Maximum 3-11/16" reveal for Top Jamb.

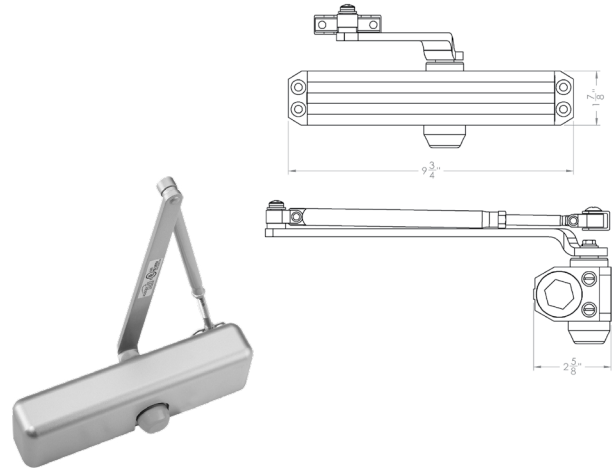

## Specifications



<b>BODY:</b>	• High strength aluminum alloy
<b>ARM OPTIONS:</b>	<ul style="list-style-type: none"> <li>• <b>PA</b> – Parallel Arm</li> <li>• <b>PS</b> – Pivot Stop Arm</li> <li>• <b>HO</b> – Hold Open</li> <li>• <b>DS/DSHO</b> – Heavy Duty Parallel Arm Stop</li> <li>• <b>RA</b> – Regular Arm</li> <li>• <b>SCS/SCSHO</b> – Heavy Duty Parallel Arm Cushion Stop</li> </ul>
<b>ADJUSTMENT:</b>	<ul style="list-style-type: none"> <li>• Separate hydraulic backcheck standard</li> <li>• Hydraulic controlled closing standard</li> </ul>
<b>SIZE:</b>	<ul style="list-style-type: none"> <li>• 3101 = Adjustable  BF - 4</li> <li>• 3100 = Adjustable 3 - 6</li> </ul>
<b>MOUNTING:</b>	<ul style="list-style-type: none"> <li>• Common 9-1/16" x 3/4" mounting hole pattern retrofits Yale® 50, Norton® 1600</li> <li>• Tri-packed for regular, top jamb and parallel arm installations</li> <li>• Includes sex nuts/bolts and screws for wood, metal doors frames</li> <li>• Self drilling self tapping screws standard</li> <li>• Separate limiting stop may be required for high abuse applications</li> </ul>
<b>COVER:</b>	• Streamline plastic cover optional
<b>COLOR FINISHES:</b>	• 689 – Aluminum, 693 – Black, 695 – Duro Bronze, 696 – Gold
<b>WARRANTY:</b>	• Twenty-five (25) year Limited Warranty
<b>CERTIFICATIONS COMPLIANCES:</b>	<ul style="list-style-type: none"> <li>• UL listed for labeled swinging fire doors rated up to and including 3 hours</li> <li>• Certified to ANSI/BHMA A156.4 Grade 1</li> <li>• Complies with ADA (Americans with Disabilities Act) and ICC/ANSI 117.1 for Accessible and Usable Buildings</li> <li>• TAA compliant. Country of origin: KR</li> </ul>



## How to Order

QUANTITY	SERIES	SIZE	BACKCHECK	ARM TYPES	FINISH	ACCESSORIES
10	31	00	BC	PA	689	—
		00 – Adjustable Size 3-6 01 – Adjustable Size BF - 4 	BC – Adjustable Hydraulic Backcheck	DS – Door Saver Arm DSHO – Door Saver Hold Open Arm HO – Hold Open, Tri-Pack PA – Tri-Pack (standard) RA – Regular Arm SCS – Spring Cushion Stop SCSHO – Spring Cushion Stop Hold open PS – Pivot Stop Arm	689 – Aluminum 693 – Black 695 – Duro Bronze 696 – Gold	BP – Back Plate BS – Blade Stop Spacer DP – Drop Plate NFB – Narrow Frame Bracket SV - Streamline Cover
						PAGE 208

## Closers

PART	SIZE	DESCRIPTION	PAINTED 689/693/695/696
3100 SERIES – ADJUSTABLE SIZES 3-6			
3100 BC PA	3-6	Closer, SNB (Tri-pack)	\$158.00
3100 BC RA	3-6	Closer, regular arm, SNB	
3100 BC PA SV	3-6	Closer, SNB (Tri-pack), Streamline Cover	\$168.00
3100 BC PA HO	3-6	Closer, hold open, SNB (Tri-pack)	\$247.00
3100 BC DS	3-6	Closer, door saver, SNB (PA Only)	\$281.00
3100 BC DSHO	3-6	Closer, door saver hold open, SNB (PA Only)	\$307.00
3100 BC SCS	3-6	Closer, door saver w/spring cushion stop, SNB (PA Only)	\$370.00
3100 BC SCSHO	3-6	Closer, door saver hold open w/spring cushion stop, SNB (PA Only)	
3100 BC PS	3-6	Closer, pivot stop (SNB for closer body only)	
3100 BC TA	3-6	Closer, track arm, streamline cover (SNB for closer body only)	\$260.00
3100 BC TAHO	3-6	Closer, rack arm hold open, streamline cover (SNB for closer body only)	
3101 SERIES – ADJUSTABLE SIZES BF-4			
3101 BC PA	BF-4	Closer, SNB (Tri-pack)	\$158.00
3101 BC RA	BF-4	Closer, regular arm, SNB	
3101 BC PA SV	BF-4	Closer, SNB (Tri-pack), Streamline Cover	\$168.00
3101 BC PA HO	BF-4	Closer, hold open, SNB (Tri-pack)	\$247.00
3101 BC DS	BF-4	Closer, door saver, SNB (PA Only)	\$281.00
3101 BC DSHO	BF-4	Closer, door saver hold open, SNB (PA Only)	\$307.00
3101 BC SCS	BF-4	Closer, door saver w/ spring cushion stop, SNB (PA Only)	\$370.00
3101 BC SCSHO	BF-4	Closer, door saver hold open w/spring cushion stop, SNB (PA Only)	
3101 BC TA	BF-4	Closer, track arm, streamline cover (SNB for closer body only)	
3101 BC TAHO	BF-4	Closer, rack arm hold open, streamline cover SNB for closer body only)	\$260.00
3101 BC PS	BF-4	Closer, pivot stop (SNB for closer body only)	

### Accessories

CODE	DESCRIPTION	LIST PRICE	
		PAINTED 689/693/695/696	UNFINISHED
<b>BS</b>	Blade Stop Spacer (no finish)	-	\$80.00
<b>BP</b>	Back Plate	\$80.00	-
<b>DPTJ</b>	Drop Plate Top Jamb		-
<b>NFB</b>	Parallel Arm NHO Bracket	\$48.00	-
<b>SDST</b>	Self Drilling Self Tapping Screws	\$12.00	-

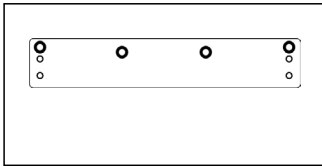

**BP - BACK PLATE**

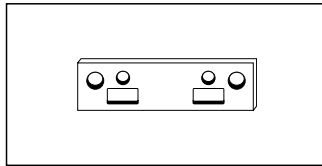

**BS - BLADE STOP SPACER**

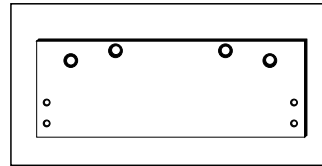

**DPTJ - DROP PLATE**

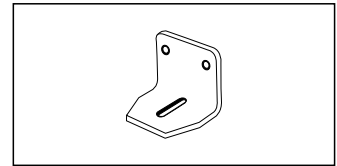

**NFB - NARROW FRAME BRACKET**

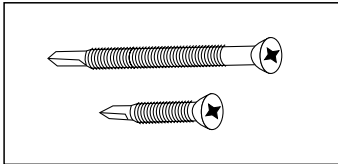

**SDST - SELF DRILLING SELF TAPPING SCREWS**

### Spring Cushion Stops



**605  
BRIGHT  
BRASS**



**613E DARK  
OXIDIZED  
SATIN BRONZE  
(EQUIVALENT)**



**630 SATIN  
STAINLESS  
STEEL**



**693 BLACK**

PDQ's SCS Series Spring Cushion Stop helps reduce wear and tear on the opening. As the door begins moving through back check to its maximum opening angle, the stop acts as a shock absorber, dampening the impact forces — See page 223

### Arms

CODE	DESCRIPTION	PART NO. (SPECIFY FINISH)	LIST PRICE
			PAINTED 689/693/695/696
<b>RA</b>	REGULAR ARM - Can be mounted REG/TJ/PA (requires PA bracket)	319003	\$80.00
<b>DS</b>	DOOR SAVER ARM (Limiting Stop) - PA application only	999005	\$160.00
<b>DSHO</b>	DOOR SAVER HOLD OPEN ARM (limiting stop) PA application only	999016	\$194.00
<b>HO</b>	HOLD OPEN ARM - can be mounted REG/TJ/PA (requires PA bracket)	999002	\$122.00
<b>PA</b>	PARALLEL ARM BRACKET - NON HOLD OPEN applications	999001	\$22.00
<b>PAHO</b>	PARALLEL ARM BRACKET- HOLD OPEN applications	999022	\$33.00
<b>PS</b>	PIVOT STOP ARM - Regular and Top Jamb Only	319018	\$184.00

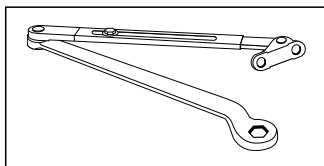

**RA** - REGULAR ARM

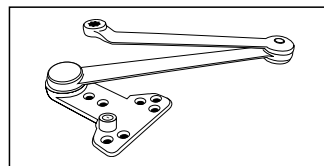

**DS** - DOOR SAVER (LIMITING STOP) ARM

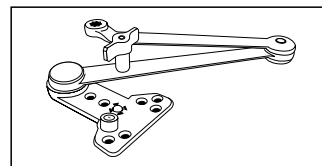

**DSHO** - DOOR SAVER (LIMITING STOP) HOLD OPEN ARM

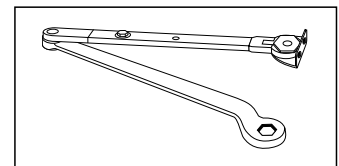

**HO** - HOLD OPEN ARM

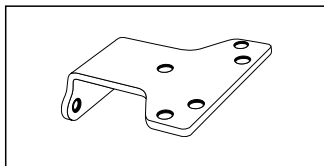

**PA** - PARALLEL ARM BRACKET

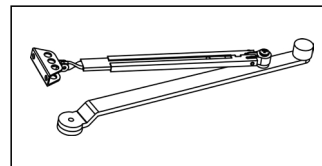
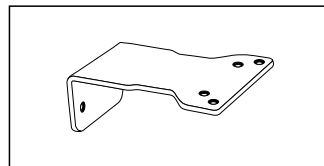

**PS** - PIVOT STOP ARM

### Covers

CODE	DESCRIPTION	PART NO. (SPECIFY FINISH)	LIST PRICE
			PAINTED 689/693/695/696
SV	STREAMLINE PLASTIC COVER	319006	\$17.00

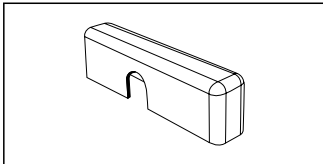

SV - STREAMLINE PLASTIC COVER

### Mounting Plates

CODE	DESCRIPTION	PART NO. (SPECIFY FINISH)	LIST PRICE
			PAINTED 689/693/695/696
BS*	BLADE STOP SPACER - Shims all PA brackets to clear 1/2" blade stop (no finish)	999026	\$80.00
BP	BACK PLATE - For regular arm applications to clear mortised stop/holder	319008	
DPTJ	TOP JAMB DROP PLATE - Required to mount TJ with limited ceiling clearance or to clear surface applied stop/holder	319009	
NFB	NARROW FRAME BRACKET - For DS/DSHO/EDS/EDAHO arms, PA and BS brackets for added reinforcement (no finish)	999011	\$48.00

\*Note: When using a Blade Stop Spacer in a narrow frame application you must use the (NFB) Narrow Frame Bracket for proper support.

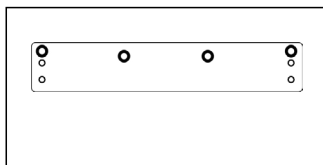

BP - BACK PLATE

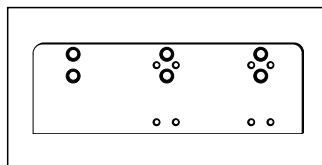

DPTJ - TOP JAMB DROP PLATE

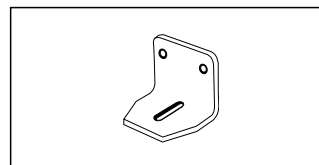

NFB - NARROW FRAME BRACKET

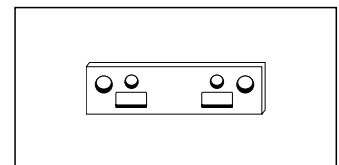

BS - BLADE STOP SPACER

### Fasteners

CODE	DESCRIPTION	PART NO. (SPECIFY FINISH)	LIST PRICE
			PAINTED 689/693/695/696
SDST	SELF DRILLING SELF TAPPING SCREWS	999007	\$12.00
SP	SCREW PACK	319020	
SNB	SEX NUTS AND BOLTS -For through bolting on unreinforced hollow core, composite or labeled fire doors 1-3/4" only. (set of 4 each)	999004	

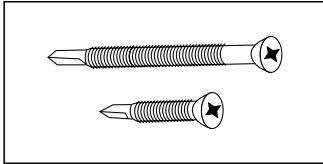

**SDST** - SELF DRILLING SELF TAPPING SCREWS

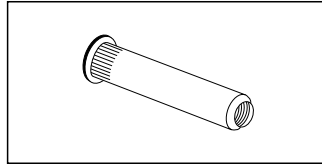

**SNB** - SEX NUTS AND BOLTS

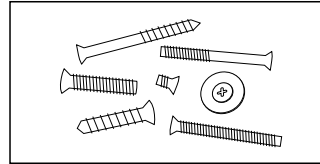

**SP** - SCREW PACK

### Parts

CODE	DESCRIPTION	PART NO. (SPECIFY FINISH)	LIST PRICE
			PAINTED 689/693/695/696
DSBS	DOOR SAVER BUMPER STOP - (no finish) Used on DS, DSHO, PS arms	999010	\$22.00
SPBL	PLASTIC SPACER BLOCK - For DS/DSHO/EDA/EDAHO and PA soffit brackets (no finish)	999031	\$10.00
SCS	SPRING CUSHION STOP* - USE with DS/DSHO for 3'0" doors (specify finish), for PA mount arms only	999032	\$150.00
SCS	SPRING CUSHION STOP* - For DS/DSHO for 4'0" doors, (specify finish), for PA mount arms only	999033	

\* Spring Cushion Stop requires purchase of a PDQ DS or DSHO arm.

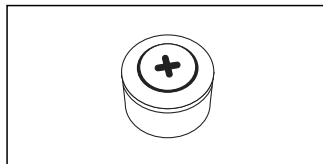

**DSBS** - DOOR SAVER BUMPER STOP

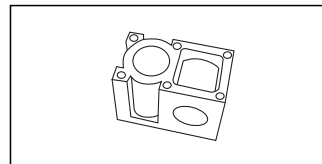

**SPBL** - PLASTIC SPACER BLOCK

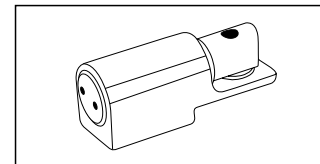

**SCS** - SPRING CUSHION STOP

### Spring Cushion Stop (SCS) Finish Match to Closers

SCS FINISH	CLOSER FINISH
605 (PVD)	605/696
613E (PVD)	695
630	625/626/689
693	693

### Cross Reference

MANUFACTURER	CLOSER SERIES				
PDQ	7100	5500	5300	5100	3100
CAL ROYAL	CR441	CR801	CR801S	900	300
CORBIN/RUSSWIN	DC8000	DC6200	DC3200	N/A	N/A
DORMA	8900	8616FC	8616	7414/7436	3800
FALCON	SC70	SC850FC	SC80	SC60/SC61	SC60
HAGER	5100	5200	5200	N/A	5300 LESS COVER
STANLEY COMMERCIAL	QDC100	QDC200F	QDC200S	N/A	QDC300
LCN	4040	1460/1461	1460/1461	1370	1260
NORTON	7500	8500	8300	160	1600
SARGENT	281	350	1430	1130/1131	1130
STANLEY	D-4550	D-3550	N/A	N/A	D-1650
ACCENTRA	5800/4400	3500	3300	51	50

## Mounting Position

### Regular Arm

Regular arm mount is a pull side application with double lever arm. The closer mounts on the door and the arm mounts to the frame. It provides the most efficient operation for door control and is commonly used on in-swing doors from corridors or other interior doors. Regular arm mount is a poor choice for exterior out-swinging doors as it would put the closer on the exterior of the building. The arm assembly projects directly out from the frame. That may be a concern for vandalism or aesthetics. Regular arm application can be used with non-hold open or hold open arms.

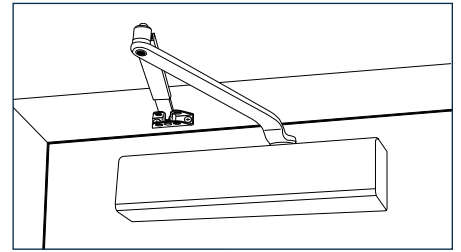

### Top Jamb

Top jamb mount is a push side double lever arm application that offers the best alternative to regular arm mount. The closer mounts to the frame and the arm mounts to the door. This application is commonly used on exterior out-swinging doors. It is a poor application for in-swinging doors from a corridor as it places the closer arm in a visible application projecting into the corridor. The arm projects out similar to regular arm mount. Therefore, it can be a concern for vandalism or aesthetics. Top jamb application can be used with non-hold open or hold open arms.

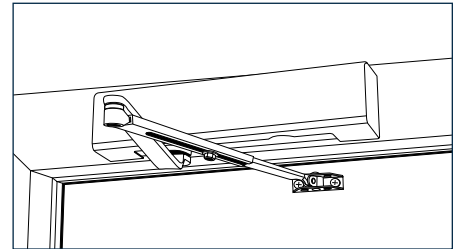

### Parallel Arm

Parallel arm mount is a push side double lever arm application. The closer is installed on the push side of the door and the arm is mounted to a parallel arm adapter plate installed to the frame soffit. The arm is approximately parallel with the face of the door, eliminating the projection condition evident with regular arm and top jamb applications. Parallel arm is often preferred where aesthetics or vandalism are concerns. Parallel arm is less efficient than regular or top jamb mounts due to the geometry of the arm. Parallel arm application can be used with non-hold open or hold open arms.

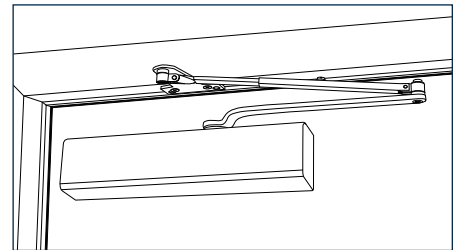

### Parallel Stop Arm (DS/DSHO) Extra Duty PA Arm (EDA/EDAHO)

The parallel stop arm mount is an enhanced version of the parallel arm application. It is similar to the parallel arm mount but incorporates a heavy duty rigid arm and soffit plate with limiting dead stop. The dead stop feature is field handed. The closer's back check function should be adjusted to cushion the impact of the stop. The parallel stop arm is intended for use where an auxiliary stop cannot be utilized. The parallel stop arm is available in non-hold open (DS) and hold open (DSHO) applications.

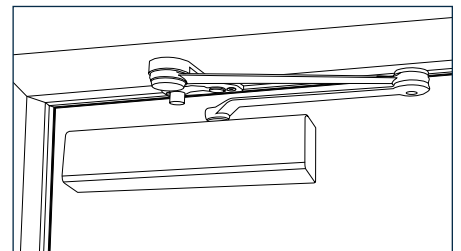

Recommend using the SCS Spring Cushion Stop for moderate to high abuse installations.

For Extra Duty PA Arm applications, specify EDA or EDAHO. Similar to DS/DSHO without the stop. Requires separate limiting stop by others.

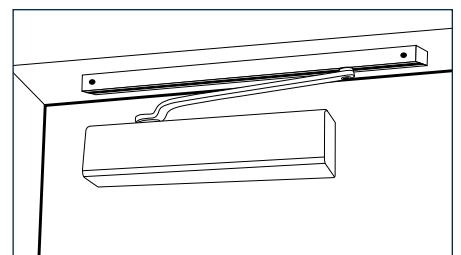

### Track Arm (TA)

The non-handed Track Arm mount incorporates a single stamped arm not designed to be used as a limiting dead stop. It's low profile helps to eliminate projecting arm conditions, which can reduce vandal damage.

### Pivot Stop (PS)

The PS (Pivot Stop) arm is designed to serve as a medium-duty door stop for situations where a door stop or overhead stop is not practical. Available in Regular and Top Jamb mounting, the PS arm uses back check to slow the door and a stop integrated into the closer arm to limit the travel of the door. The PS arm limits the travel of the door to a specific, templated angle. Templating is available for opening angles from 85 to 110 degrees in 5 degree increments. The PS arm is not available with hold-open.

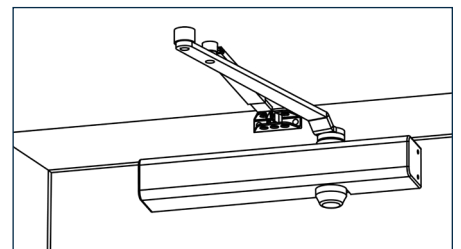

## SPRING CUSHION STOP



**630 SATIN STAINLESS  
STEEL**



**613E DARK OXIDIZED  
SATIN BRONZE  
(EQUIVALENT)**



**605 BRIGHT  
BRASS**



**693 BLACK**

PDQ's SCS Series Spring Cushion Stop helps reduce wear and tear on the opening. As the door begins moving through backcheck to its maximum opening angle, the stop acts as a shock absorber, dampening the impact forces.

## Features

- The unit is an **add-on kit** that can be included as an option on DS/DSHO arms.
- It also can be installed on existing DS/DSHO arm applications using the existing threaded hole for the bumper stop and one of the mounting screw holes.
- The spring cushion kit is available in two spring sizes, allowing it to be tailored to provide more effective cushioning for specific door widths
- Designed to be self aligning, the unit works with any door that incorporates a PDQ DS/DSHO arm with a cushioned bumper (won't fit with old style metal bumper).
- Manufactured from investment cast stainless steel for corrosion resistance and durability
- The 99032/99033 does not alter or decrease the strength of the DS/DSHO arm.
- Hand is determined in the field and reversible for LH and RH doors

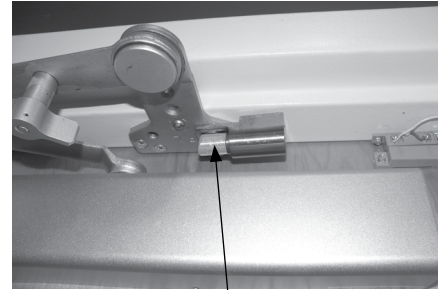

NOTE: PLUNGER HIGHLIGHTED TO ENHANCE THE CUSHIONING FEATURE.

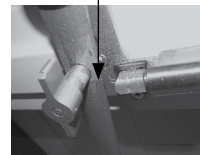

STOP SHOWN BEFORE  
DOOR IS FULLY OPENED

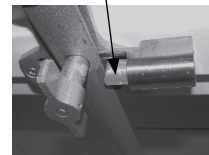

STOP SHOWN WHEN  
DOOR IS FULLY OPENED

## Specifications



<b>HANDING:</b>	• Field Reversible
<b>DOOR SIZES:</b>	• SCS-1 for 3'0" X 8'0" doors • SCS-2 for 4'0" X 8'0" doors
<b>FINISHES:</b>	• 605 (US3) – Bright Brass (PVD), 613E – Dark Oxidized Satin Bronze (Equivalent) (PVD), 630 (US32D) – Satin Stainless Steel, 693 – Black Note: PVD (Physical Vapor Deposition) coated finishes offer outstanding resistance to wear, durability and corrosion.

## Spring Cushion Stop

PART	CODE	DESCRIPTION	LIST PRICE 605/613E/630/693
999032 Specify Finish	<b>SCS-1</b>	For 3'0" X 8'0" wood or hollow metal doors and frames	\$150.00
999033 Specify Finish	<b>SCS-2</b>	For 4'0" X 8'0" wood or hollow metal doors and frames	



## Spirit Series

---

### LOCK SOLUTIONS

**Applications**

A wide range of electronic locks powered by Spirit! Seamlessly connects with the PDQ Spirit app.

---

### SPIRIT APP

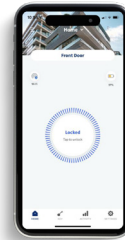
**Applications**

The Spirit App is your idea solution for bluetooth and Wi-Fi based access control. You can now easily control all Spirit door hardware from your phone!

## SDE Push Button Lock

---

### SDE

**Applications**

The SDE is the ideal solution for securing entry and common area doors in multifamily and commercial applications. This cylindrical lock requires no wiring and provides easy PIN only access. Basic weather resistance means the lock can be used on exterior facings doors.

## ACCESS CONTROL CREDENTIALS



PHONE



RFID



KEY



PIN

## Features

- Built from PDQ's KM Series Heavy Duty Deadbolt
- Designed for quick installation
- 4 AA Alkaline batteries last up to 2 years or 5V DC
- Able to schedule specific access windows
- Log and track access events and status
- Monitors and protects openings with door obstruction alerts
- Battery status and low battery alerts

## Specifications



ADA COMPLIANT

<b>DOOR THICKNESS:</b>	• 1-3/8" to 1-3/4"
<b>BACKSET:</b>	• 2-3/8" - 2-3/4" (Adjustable)
<b>CREDENTIALS:</b>	• RFID • Smartphone • PIN • Mechanical Key
<b>KEYWAYS:</b>	• Conventional • SFIC • High Security • UL437
<b>CREDENTIAL COMPATIBILITIES:</b>	• Prox (Optional) • MIFARE DESFire EV1/EV2/EV3/Light • MIFARE Ultralight EV1/AES • MIFARE Classic
<b>COMMUNICATION:</b>	• BLE 4.2 • BLE 5.2
<b>ENCRYPTION:</b>	• AES 256
<b>BATTERIES REQUIRED:</b>	• 4 AA Alkaline Batteries
<b>OPERATING TEMPERATURES:</b>	• -20C to 65C • 0-95% Humidity (Non-Condensing)
<b>CERTIFICATIONS &amp; COMPLIANCES:</b>	• FCC Part 15 • UL/cUL 10C 20-Minutes • Complies with ADA (Americans with Disabilities Act)
<b>MODES:</b>	• Standalone • Online
<b>FINISHES:</b>	• 606 (US4), 613E, 622 (US19), 626 (US26D)
<b>WARRANTY:</b>	• Two (2) year Mechanical / Two (2) year Electronics
<b>COUNTRY OF ORIGIN:</b>	• Assembled in USA



EXTERIOR VIEW



INTERIOR VIEW

## Cylinders



## Architectural Finishes



606 (US4)  
Satin Brass



613E  
Dark Oxidized Satin  
Bronze (Equivalent)



622 (US19)  
Flat Black



626 (US26D)  
Satin Chromium



# KMS-SP Heavy Duty Deadbolt

## How to Order

QTY	SERIES	FAMILY	CREDENTIAL	FUNCTION	FINISH	BACKSET	CYLINDER	KEYWAY	KEYING
	<b>KMS</b>	<b>SP</b>	<b>N</b>	<b>116</b>	<b>626</b>	<b>ADJ</b>	<b>D</b>	<b>SCC</b>	<b>KD</b>
			N - Card NK - Card + Keypad		606 613E 622 626	ADJ - Adjustable 2-3/4" - 2-3/8"	See Cylinders	See Keyways	<b>KD</b> - Keyed Different <b>KO</b> - Zero Bitted <b>KA</b> - Keyed Alike <b>KE</b> - Keyed to Existing <b>MK</b> - Master Key <b>CMK</b> - Construction Master Key

	PRICE
<b>KMS - SP - N</b>	\$ 900.00
<b>KMS - SP - NK</b>	\$ 1000.00

## ACCESS CONTROL CREDENTIALS



PHONE



RFID



KEY



PIN

### Features

- Built from PDQ's CL Series Interconnected Lock
- Designed for quick installation
- 4 AA Alkaline batteries last up to 2 years or 5V DC
- Able to schedule specific access windows
- Log and track access events and status
- Monitors and protects openings with door obstruction alerts
- Battery status and low battery alerts



EXTERIOR VIEW

### Specifications



ADA COMPLIANT

DOOR THICKNESS:	• 1-3/8" to 1-3/4"
BACKSET:	• 2-3/4" (Adjustable)
CREDENTIALS:	• RFID • Smartphone • PIN • Mechanical Key
KEYWAYS:	• Conventional • SFIC • High Security • UL437
CREDENTIAL COMPATIBILITIES:	• Prox (Optional) • MIFARE DESFire EV1/EV2/EV3/Light • MIFARE Ultralight EV1/AES • MIFARE Classic
COMMUNICATION:	• BLE 4.2 • BLE 5.2
ENCRYPTION:	• AES 256
BATTERIES REQUIRED:	• 4 AA Alkaline Batteries
OPERATING TEMPERATURES:	• -20C to 65C • 0-95% Humidity (Non-Condensing)
CERTIFICATIONS & COMPLIANCES:	• FCC Part 15 • UL/cUL 10C 20-Minutes • Complies with ADA (Americans with Disabilities Act)
MODES:	• Standalone • Online
FINISHES:	• 606 (US4), 613E, 622 (US19), 626 (US26D)
WARRANTY:	• Two (2) year Mechanical / Two (2) year Electronics
COUNTRY OF ORIGIN:	• Assembled in USA

### Cylinders



### Levers



PHILADELPHIA – PHL



BOSTON – BSN



MIAMI – MIA



ORLANDO – ORL

### Architectural Finishes



606 (US4)  
Satin Brass



613E  
Dark Oxidized Satin  
Bronze (Equivalent)



622 (US19)  
Flat Black



626 (US26D)  
Satin Chromium





# CLS-SP Interconnected Lock

## How to Order

QTY	SERIES	FAMILY	CREDENTIAL	FUNCTION	LEVER	FINISH	BACKSET	STRIKE	CYLINDER	KEYWAY	KEYING
	CLS	SP	N	126	PHL	626	ADJ	ASA	D	SCC	KD
			N - Card NK - Card + Keypad		BSN MIA ORL PHL	606 613E 622 626	ADJ - Adjustable 2-3/4" - 2-3/8"	ASA - ANSI/ASA (standard) FL - Full Lip T - "T" Strike	See Cylinders	See Keyways	KD - Keyed Different KO - Zero Bitted KA - Keyed Alike KE - Keyed to Existing MK - Master Key CMK - Construction Master Key

## Strikes

	CODE	DESCRIPTION
	ASA	ASA Strike 1-1/4" x 4-7/8"
	T	T-Strike 1-1/8" x 2-3/4"
	FL	Full Lip Strike 1-5/8" x 2-1/4"

	PRICE
CLS - SP - N	\$ 1300.00
CLS - SP - NK	\$ 1400.00

## ACCESS CONTROL CREDENTIALS



PHONE



RFID



KEY



PIN

## Features

- Built from PDQ's SD Series Grade 2 Cylindrical Lock
- Designed for quick installation
- 4 AA Alkaline batteries last up to 2 years or 5V DC
- Able to schedule specific access windows
- Log and track access events and status
- Enable auto lock/unlock for enhanced security
- Battery status and low battery alerts

## Specifications



<b>DOOR THICKNESS:</b>	• 1-3/8" to 1-3/4"
<b>BACKSET:</b>	• 2-3/8" • 2-3/4" (Standard) • 5"
<b>CREDENTIALS:</b>	• RFID • Smartphone • PIN • Mechanical Key
<b>KEYWAYS:</b>	• Conventional • SFIC • High Security • UL437
<b>CREDENTIAL COMPATIBILITIES:</b>	• Prox (Optional) • MIFARE DESFire EV1/EV2/EV3/Light • MIFARE Ultralight EV1/AES • MIFARE Classic
<b>COMMUNICATION:</b>	• BLE 4.2 • BLE 5.2
<b>ENCRYPTION:</b>	• AES 256
<b>BATTERIES REQUIRED:</b>	• 4 AA Alkaline Batteries
<b>OPERATING TEMPERATURES:</b>	• -20C to 65C • 0-95% Humidity (Non-Condensing)
<b>CERTIFICATIONS &amp; COMPLIANCES:</b>	• FCC Part 15 • UL/cUL 10C 20-Minutes • Complies with ADA (Americans with Disabilities Act)
<b>MODES:</b>	• Standalone • Online
<b>FINISHES:</b>	• 606 (US4), 613E, 622 (US19), 626 (US26D)
<b>WARRANTY:</b>	• Two (2) year Mechanical / Two (2) year Electronics
<b>COUNTRY OF ORIGIN:</b>	• Assembled in USA



EXTERIOR VIEW

## Cylinders



## Levers



PHILADELPHIA – PHL



BOSTON – BSN



MIAMI – MIA



MEMPHIS – MEM



ORLANDO – ORL

## Architectural Finishes



606 (US4)  
Satin Brass



613E  
Dark Oxidized Satin  
Bronze (Equivalent)



622 (US19)  
Flat Black



626 (US26D)  
Satin Chromium



# SDS-SP Cylindrical Lock

## How to Order

QTY	SERIES	FAMILY	CREDENTIAL	FUNCTION	LEVER	FINISH	HANDING	BACKSET	STRIKE	CYLINDER	KEYWAY	KEYING
	SDS	SP	N	116	PHL	626	RH*	234	ASA	D	SCC	KD
			N - Card NK - Card + Keypad		BSN MIA MEM ORL PHL	605 613E 622 626	LH RH	2-3/4" (standard) 238 - 2-3/8" 5 - 5"	ASA - ANSI/ASA (standard) FL - Full Lip T - "T" Strike	See Cylinders	See Keyways	KD - Keyed Different KO - Zero Bitted KA - Keyed Alike KE - Keyed to Existing MK - Master Key CMK - Construction Master Key

## Strikes

	CODE	DESCRIPTION
	ASA	ASA Strike 1-1/4" x 4-7/8"
	T	T-Strike 1-1/8" x 2-3/4"
	FL	Full Lip Strike 1-5/8" x 2-1/4"

	PRICE
SDS - SP - N	\$ 1000.00
SDS - SP - NK	\$ 1100.00

## ACCESS CONTROL CREDENTIALS



PHONE



RFID



KEY



PIN

## Features

- Built from PDQ's World-Class GT Series Grade 1 Cylindrical Lock
- Designed for quick installation
- 4 AA Alkaline batteries last up to 2 years or 5V DC
- Able to schedule specific access windows
- Log and track access events and status
- Enable auto lock/unlock for enhanced security
- Battery status and low battery alerts
- Local-activated lockdown for instant door security
- Do not disturb mode that temporarily blocks access
- Monitor egress with request to exit function

## Specifications



<b>DOOR THICKNESS:</b>	• 1-3/4" to 2-1/4"
<b>BACKSET:</b>	• 2-3/4" (Standard) • 5" (Optional)
<b>CREDENTIALS:</b>	• RFID • Smartphone • PIN • Mechanical Key
<b>KEYWAYS:</b>	• Conventional • SFIC • High Security • UL437
<b>CREDENTIAL COMPATIBILITIES:</b>	• Prox (Optional) • MIFARE DESFire EV1/EV2/EV3/Light • MIFARE Ultralight EV1/AES • MIFARE Classic
<b>COMMUNICATION:</b>	• BLE 4.2 • BLE 5.2
<b>ENCRYPTION:</b>	• AES 256
<b>BATTERIES REQUIRED:</b>	• 4 AA Alkaline Batteries
<b>OPERATING TEMPERATURES:</b>	• -20C to 65C • 0-95% Humidity (Non-Condensing)
<b>CERTIFICATIONS &amp; COMPLIANCES:</b>	• FCC Part 15 • UL/cUL 10C 45-Minutes • Complies with ADA (Americans with Disabilities Act)
<b>MODES:</b>	• Standalone • Online
<b>FINISHES:</b>	• 606 (US4), 613E, 622 (US19), 626 (US26D)
<b>WARRANTY:</b>	• Twenty-Five (25) year Mechanical / Two (2) year Electronics
<b>COUNTRY OF ORIGIN:</b>	• Assembled in USA



EXTERIOR VIEW



INTERIOR VIEW

## Cylinders



## Levers



PHILADELPHIA – PHL BOSTON – BSN MIAMI – MIA

## Architectural Finishes



606 (US4)  
Satin Brass

613E  
Dark Oxidized Satin  
Bronze (Equivalent)



622 (US19)  
Flat Black

626 (US26D)  
Satin Chromium





# GTS-SP Cylindrical Lock

## How to Order

QTY	SERIES	FAMILY	CREDENTIAL	FUNCTION	LEVER	FINISH	HANDING	BACKSET	STRIKE	CYLINDER	KEYWAY	KEYING
	GTS	SP	N	116	PHL	626	RH*	234	ASA	D	SCC	KD
			N - Card NK - Card + Keypad		BSN MIA PHL	606 613E 622 626	LH RH	2-3/4" (standard)  5 - 5"	ASA - ANSI/ASA (standard)  FL - Full Lip  T - "T" Strike	See Cylinders	See Keyways	KD - Keyed Different  KO - Zero Bitted  KA - Keyed Alike  KE - Keyed to Existing  MK - Master Key  CMK - Construction Master Key

\*Handed but field reversible.

## Strikes

	CODE	DESCRIPTION
	ASA	ASA Strike 1-1/4" x 4-7/8"
	T	T-Strike 1-1/8" x 2-3/4"
	FL	Full Lip Strike 1-5/8" x 2-1/4"

	PRICE
GTS - SP - N	\$ 1425.00
GTS - SP - NK	\$ 1525.00

# MRS-SP

# Mortise Lock Sectional Trim

## ACCESS CONTROL CREDENTIALS



PHONE



RFID



KEY



PIN

## Features

- Built from PDQ's World-Class MR Series Grade 1 Mortise Lock
- Designed for quick installation
- 4 AA Alkaline batteries last up to 2 years or 5V DC
- Able to schedule specific access windows
- Log and track access events and status
- Enable auto lock/unlock for enhanced security
- Battery status and low battery alerts
- Do not disturb mode that temporarily blocks access
- Key override lets you know when the key has been used
- Latchbolt monitor lets you know when the lock has been used
- Monitor egress with request to exit function

## Specifications



<b>DOOR THICKNESS:</b>	• 1-3/4" (Standard) • 2" • 2-1/4" (Optional)
<b>CREDENTIALS:</b>	• RFID • Smartphone • PIN • Mechanical Key
<b>KEYWAYS:</b>	• Conventional • SFIC • LFIC • High Security • UL437
<b>CREDENTIAL COMPATIBILITIES:</b>	• Prox (Optional) • MIFARE DESFire EV1/EV2/EV3/Light • MIFARE Ultralight EV1/AES • MIFARE Classic
<b>COMMUNICATION:</b>	• BLE 4.2 • BLE 5.2
<b>ENCRYPTION:</b>	• AES 256
<b>BATTERIES REQUIRED:</b>	• 4 AA Alkaline Batteries
<b>OPERATING TEMPERATURES:</b>	• -20C to 65C • 0-95% Humidity (Non-Condensing)
<b>CERTIFICATIONS &amp; COMPLIANCES:</b>	• FCC Part 15 • UL/cUL 10C 3-Hour • Complies with ADA (Americans with Disabilities Act)
<b>MODES:</b>	• Standalone • Online
<b>FINISHES:</b>	• 606 (US4), 613E, 622 (US19), 626 (US26D)
<b>WARRANTY:</b>	• Limited Lifetime Mechanical / Two (2) year Electronics
<b>COUNTRY OF ORIGIN:</b>	• Assembled in USA



EXTERIOR VIEW

## Cylinders



## Rose Designs



ROUND ROSE  
F-TRIM

SQUARE ROSE (SR)  
J-TRIM

## Levers



PHILADELPHIA – PHL



BOSTON – BSN



CHICAGO – CHI



MIAMI – MIA



MEMPHIS – MEM



DALLAS – DAL



ORLANDO – ORL



LOS ANGELES – LA

## Architectural Finishes



606 (US4)  
Satin Brass



613E  
Dark Oxidized Satin  
Bronze (Equivalent)



622 (US19)  
Flat Black



626 (US26D)  
Satin Chromium



# MRS-SP Mortise Locks

FUNCTION NUMBER	OUTSIDE   INSIDE	DESCRIPTION
116		<ul style="list-style-type: none"> <li>• Key outside retracts latchbolt</li> <li>• Inside lever retracts latchbolt</li> <li>• Supports lock modes (Normal, Apartment)</li> </ul>
136		<ul style="list-style-type: none"> <li>• Key outside extends/retracts deadbolt</li> <li>• Thumbturn inside extends/retracts deadbolt (Privacy)</li> <li>• Inside lever retracts deadbolt and latchbolt</li> <li>• Supports lock modes (Normal, Apartment, Privacy)</li> </ul>
146		<ul style="list-style-type: none"> <li>• Key outside retracts thumbturn and latchbolt</li> <li>• Thumbturn inside (Privacy)</li> <li>• Inside lever retracts thumbturn and latchbolt</li> <li>• Supports lock modes (Normal, Apartment, Privacy)</li> </ul>
147		<ul style="list-style-type: none"> <li>• Key outside retracts thumbturn and latchbolt</li> <li>• Thumbturn inside (Passage)</li> <li>• Inside lever retracts latchbolt</li> <li>• Supports lock modes (Normal, Passage)</li> </ul>

## How to Order

QTY	SERIES	FAMILY	CREDENTIAL	FUNCTION	LEVER	TRIM	FINISH	HANDING	BACKSET	STRIKE	CYLINDER	KEYWAY	KEYING
	MRS	SP	N	116	PJ	SJ	626	RH**	234	ASA	See Cylinders	See Keyways	KD
			N - Card NK - Card + Keypad	116 136 146 147	J-TRIM	J-TRIM	606 613E 622 630	RHR  LH LHR	234 - 2-3/4"				KD - Keyed Different KO - Zero Bitted KA - Keyed Alike KE - Keyed to Existing MK - Master Key CMK - Construction Master Key
					PJ - PHL BJ - BSN MJ - MIA CJ - CHI DJ - DAL OJ - ORL LJ - LA TJ-MEM*	SJ - Sectional Round Rose  SR - Sectional Square Rose		*MEM specify handing. **Handed but field reversible. Memphis handed only.					

	PRICE
MRS - SP - N	\$ 1650.00
MRS - SP - NK	\$ 1750.00



# 6EWS-SP

# Exit Device Trim

## ACCESS CONTROL CREDENTIALS



PHONE



RFID



KEY



PIN

## Features

- Built from PDQ's World-Class 6W Series Exit Device Trim
- For use with PDQ's 6300 Series RIM and Surface Vertical Rod
- 4 AA Alkaline batteries last up to 2 years or 5V DC
- Able to schedule specific access windows
- Log and track access events and status
- Enable auto lock/unlock for enhanced security
- Battery status and low battery alerts



EXTERIOR VIEW

## Cylinders



## Levers



PHILADELPHIA – PHL



BOSTON – BSN



MIAMI – MIA



CHICAGO – CHI



ORLANDO – ORL

## Specifications



ADA COMPLIANT

DOOR THICKNESS:	• 1-3/4" to 2-1/4"
CREDENTIALS:	• RFID • Smartphone • PIN • Mechanical Key
KEYWAYS:	• Conventional • SFIC • LFIC • High Security • UL437
CREDENTIAL COMPATIBILITIES:	• Prox (Optional) • MIFARE DESFire EV1/EV2/EV3/Light • MIFARE Ultralight EV1/AES • MIFARE Classic
COMMUNICATION:	• BLE 4.2 • BLE 5.2
ENCRYPTION:	• AES 256
BATTERIES REQUIRED:	• 4 AA Alkaline Batteries
OPERATING TEMPERATURES:	• -20C to 65C • 0-95% Humidity (Non-Condensing)
CERTIFICATIONS & COMPLIANCES:	• FCC Part 15 • UL/cUL 10C 3-Hour • Complies with ADA (Americans with Disabilities Act)
MODES:	• Standalone • Online
FINISHES:	• 606 (US4), 613E, 622 (US19), 626 (US26D)
WARRANTY:	• Two (2) year Electronics
COUNTRY OF ORIGIN:	• Assembled in USA

## Architectural Finishes



606 (US4)  
Satin Brass



613E  
Dark Oxidized Satin  
Bronze (Equivalent)



622 (US19)  
Flat Black



626 (US26D)  
Satin Chromium



# 6EWS-SP Exit Device Trim

## How to Order

QTY	SERIES	FAMILY	CREDENTIAL	LEVER	TYPE	FINISH	HANDING	CYLINDER	KEYWAY	KEYING	OPTIONS
	6EWS	SP	N	PHL	R	613E	RH*	See Cylinders	See Keyways	KD	
			N - Card NK - Card + Keypad	BSN CHI MIA ORL PHL	R - Rim V - Surface Vertical Rod	606 613E 622 626	LH RH			KD - Keyed Different KO - Zero Bitted KA - Keyed Alike KE - Keyed to Existing MK - Master Key CMK - Construction Master Key	VD1 PR1 YC1 DK1 HG1

\*Handed but field reversible.  
\*PDQ Finish designations do not indicate base material.

CODE	DESCRIPTION	PRICING
VD1	6EWS Trim adapted to fit existing Von Duprin 98/99 device	\$100.00
PR1	6EWS Trim adapted to fit existing Precision 2100 device	\$100.00
YC1	6EWS Trim adapted to fit existing Yale 7000 or Corbin Russwin ED5000 device	\$100.00
DK1	6EWS Trim adapted to fit existing Dorma 9300 device	\$100.00
HG1	6EWS Trim for Hager 4500 series / PDQ 6200 series	\$100.00

	PRICE
6EWS - SP - N	\$ 1800.00
6EWS - SP - NK	\$ 1900.00

# SPIRIT CREDENTIALS



Fob



Card

## Specifications

PART #	TECHNOLOGY	FORMAT	COLORS / GRAPHICS	MOQ	PRICE
9010	Mifare Classic 1k	Card	PDQ Graphic	10	\$10.00 ea
9020-Blue	Mifare Classic 1k	Fob	Blue	10	\$10.00 ea

# PDQ SPIRIT APP



## Features

The Spirit App is your ideal solution for bluetooth based access control. You can now easily control all Spirit door hardware from your phone! The app is available for free for iOS devices.

Here are some key features:

- View an activity log of user access and device status
- Add / manage multiple Spirit devices in one place
- Set your ideal locking mode (normal operation, passage, privacy, or apartment)
- See your connection status and how it's connected
- Add users and guests with card, pin, and mobile access
- Receive notifications when battery levels are low
- Update lock software

\* Max 25 locks and 50 users\*

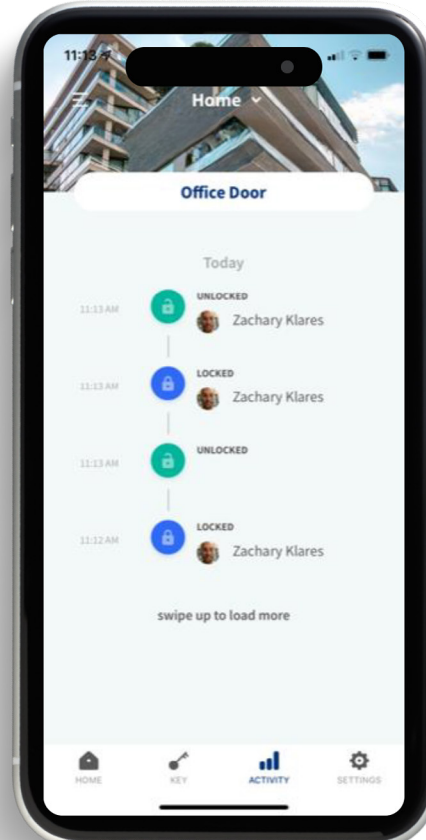
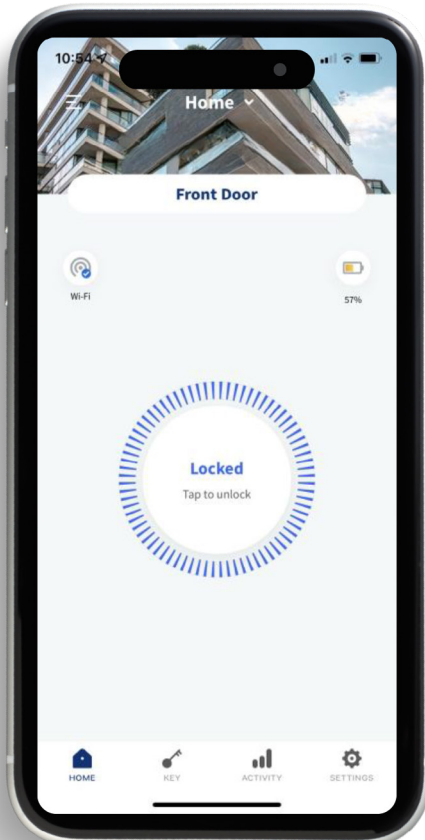

# SDE SERIES

# Push Button Lock

## Typical Applications

- Multi-Family
- Commercial

## Features

- PIN & Mechanical Key
- 20 permanent PIN codes
- One-time (temporary) PIN, silent mode, auto-lock, time delay, and vacation mode
- Operated in standalone mode



EXTERIOR VIEW

## Specifications



ADA COMPLIANT

<b>FOR DOORS:</b>	• 1-3/8" - 2"
<b>BACKSET:</b>	• 2-3/8" - 2-3/4" (Adjustable)
<b>STRIKE:</b>	• "T" strike default
<b>LATCHBOLT:</b>	• 2-3/8" - 2-3/4" (Adjustable)
<b>HAND:</b>	• Reversible Handing
<b>BATTERIES REQUIRED:</b>	• 4 AA Alkaline Batteries
<b>CERTIFICATIONS &amp; COMPLIANCES:</b>	• Complies with ADA (Americans with Disabilities Act)
<b>FINISHES:</b>	• 619 (US15), 622 (US19)
<b>WARRANTY:</b>	• One (1) Year Mechanical and One (1) Year Electronics

## Architectural Finishes



619 (US15)  
Satin Nickel

622 (US19)  
Flat Black

## How to Order

QUANTITY	SERIES	FINISH
1	SDE	622
		619

	PRICE
SDE	\$ 350.00



## Locks

**MR199A**  
Electrified Mortise

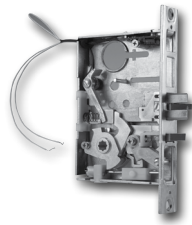

**Applications**  
Electrified locks complement the mechanical offering and are typically incorporated into a wired access control system or used independently with a remote access switch. - p. 9

**XGT/GT199A**  
Electrified Cylindrical

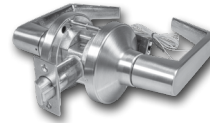

**Applications**  
Electrified locks complement the mechanical offering and are typically incorporated into a wired access control system or used independently with a remote access switch. - p. 34

## Exit Devices and Trim

**6300/6400**  
Electrified Options



**Applications**  
Access control exit device options including request to exit signal switch, latch bolt monitor, and battery powered alarms.

**6W99**  
Electrified Trim



**Applications**  
Electrified trim complements the mechanical offering and is typically incorporated into a wired access control system or used independently with a remote access switch. — p. 160

**MLR**  
Motorized Latch Retraction

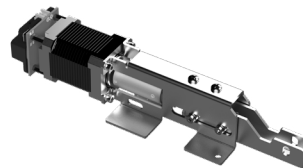

**Applications**  
An ideal solution for integrated exit device access control solutions requiring operational noise reduction such as Healthcare, K-12, higher education, museums, auditoriums, theaters, etc.

**DE**  
Delayed Egress



**Applications**  
This Delayed Egress exit device is designed to slow the egress or exit from a particular area, usually for security reasons or to prevent unauthorized access. Designed for the 6300 and 6400 exit device. Available in Rim, concealed vertical rod, and mortise devices.

---

## Electrified Hinges



### Applications

Electric hinges are used when a locking device is mounted on a moving door and power and signals must be brought off the door to the controller and house wiring. Examples of such locking devices include an electrified lockset or electrically actuated trim, electric latch retraction device or a switching device such as a REX lever or touchbar. — p. 226

---

## Electric Strikes



### Applications

Electromechanical door locking device for use with various latch bolt locksets in lieu of conventional Strikes that provide additional security, traffic control and convenience of remote operation. — p. 217

---

## Key Switches



### Applications

Key switches can be activated only by the use of a key. Typical applications include situations where access needs to be restricted to the switch's functions. — p. 218

---

## Push Buttons



### Applications

Commonly used on ADA openings in conjunction with an automatic operator. — p. 218

---

## Power Supplies

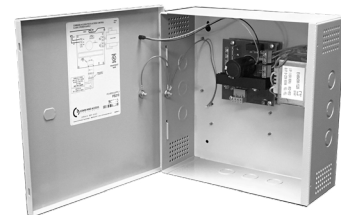

### Applications

Power sources used to support electronic access control devices. — p. 219

# 8500/9910 SERIES

## Electric Strikes



### Specifications for 85001 and 85003

<b>85001 ELECTRIC STRIKE:</b>	• Designed for use with all PDQ Grade 1 and Grade 2 Cylindrical Locks
<b>85003 ELECTRIC STRIKE:</b>	• Designed for use with all PDQ MR Series Mortise Locks WITHOUT Deadbolt
<b>FEATURES:</b>	<ul style="list-style-type: none"> <li>• Input voltage:12-24 VDC</li> <li>• Field changeable from FAIL SECURE to FAIL SAFE</li> <li>• Factory tested to 1,000,000 cycle</li> </ul>
<b>CURRENT:</b>	<ul style="list-style-type: none"> <li>• 0.28A @ 12 VDC</li> <li>• 0.14A @ 24 VDC</li> </ul>
<b>FINISH:</b>	• 630 (US32D) Satin Stainless Steel

### Specifications for 9910

<b>9910 ELECTRIC STRIKE:</b>	• Designed for use with all PDQ 6300 / 6400 Rim Exit Devices
<b>FEATURES:</b>	<ul style="list-style-type: none"> <li>• Completely surface-mounted</li> <li>• Accommodates 1/2" to 3/4" (13mm–19mm) latch projection</li> <li>• Mounting spacer included to provide enhanced latch engagement</li> <li>• Stainless steel ensures superior strength and creates a sleek aesthetic design</li> <li>• Horizontal adjustment ensures proper latch positioning to compensate for door misalignment – up to 1/4" (6.4mm)</li> <li>• Conventional keeper design</li> <li>• Plug-in wire connectors</li> <li>• Lockdown holes for secure mount</li> <li>• HEX socket head cap screws for added support</li> <li>• Installation tool included</li> <li>• Non-handed</li> </ul>
<b>CERTIFICATIONS, LISTINGS, COMPLIANCES:</b>	<ul style="list-style-type: none"> <li>• 1,500lbf Static</li> <li>• 70 ft-lb Dynamic</li> <li>• 250,000 Cycles</li> <li>• Fail-Secure</li> <li>• 3-Hour Fire Rated</li> </ul>
<b>CURRENT:</b>	• 500mA Field-Selectable 12/24VDC & 12-24VAC (Max at 12VDC)
<b>WARRANTY:</b>	• 5 Year Limited Warranty
<b>FINISH:</b>	• 630 (US32D) Satin Stainless Steel

### Electric Strikes

PART NO.	DESCRIPTION	LIST PRICE
85001	For Cylindrical Locks	\$650
85003	For Mortise locks (no Deadbolt)	
9910	For 6300 / 6400 Exit Devices	\$1125



## Specifications

**FEATURES:**

- Molex Connector on one end with other end pinned (ASSA Configuration)
- Quick and easy installation
- Wires are coordinated to work with other PDQ electro-mechanical hardware products
- Easy disconnect to allow fast and safe maintenance on products

MODEL NUMBERS:	FEATURES:	PRICE:
ISMC - 6	6" Wire Harness	\$55.00
ISMC - 38	38" Wire Harness	\$85.00
ISMC - 44	44" Wire Harness	\$95.00
ISMC - 50	50" Wire Harness	\$105.00
ISMC - 192	192" Wire Harness	\$225.00

# EPT100

# Electric Power

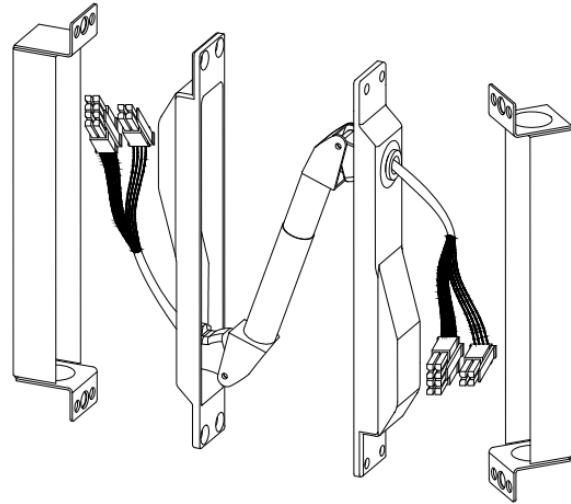

## Specifications

<b>MODEL NUMBERS:</b>	<ul style="list-style-type: none"> <li>• EPT100 - ISMC US28</li> <li>• EPT100 - ISMC S4</li> </ul>
<b>FEATURES:</b>	<ul style="list-style-type: none"> <li>• (12) 24 AWG wires with Industry Standard Molex Connectors (ISMC)</li> <li>• Max Rating: 24 VDC, 1A</li> <li>• Mortises into door and frame and is completely concealed when door is closed</li> <li>• UL / ULC Listed for fire doors</li> </ul>
<b>FINISHES:</b>	<ul style="list-style-type: none"> <li>• US28 (628) - Satin Aluminum</li> <li>• S4 (693) - Black Painted</li> </ul>

MODEL NUMBER	PRICE
EPT100 - ISMC US28	\$750.00
EPT100 - ISMC S4	\$750.00

# 8100 SERIES

## Key Switches Push Buttons



Key Switch W/Lights  
81310-2MT / 81310-2MM



Key Switch  
81310-4MT / 81310-4MM



Push Button Switch  
81320-1MT / 81320-1MM



Push Button Switch Narrow  
81320-6MT / 81320-6MM



Mushroom Push Button  
81320-5MT / 81320-5MM

### Electrified Accessories

PART NUMBER	DESCRIPTION	LIST PRICE
81310-2MT	62 Key Switch with Lights Maintained	\$386.00
81310-2MM	62 Key Switch with Lights Momentary	
81310-4MT	62 Key Switch Narrow Maintained	\$352.00
81310-4MM	62 Key Switch Narrow Momentary	
81320-1MT	62 Push Button Maintained	\$246.00
81320-1MM	62 Push Button Momentary	
81320-5MT	62 Push Button Mushroom Maintained	\$376.00
81320-5MM	62 Push Button Mushroom Momentary	
81320-6MT	62 Push Button Narrow Maintained	\$280.00
81320-6MM	62 Push Button Narrow Momentary	

# PS SERIES

# Power Supplies

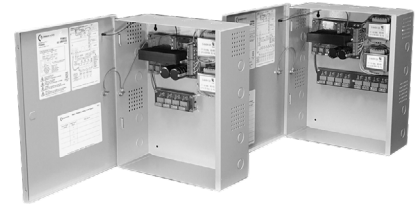
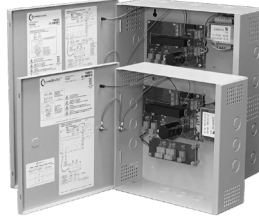
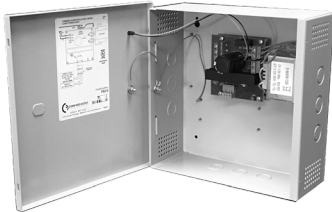

## Features

- Filtered/Regulated 24 Volts DC
- Overload, Over Voltage and Short Circuit Protection
- Accepts 110-120VAC
- Controls Fail Safe or Fail Secure Locking Devices
- Interface Relay Isolates Locking Device Current from Control Switch
- Auxiliary 24VDC Constant Voltage Output for Powering Stand Alone Devices, Such as, Keypads, Motion Detectors and Status Indicators (Model PS220 and PS22B only)
- Surge Suppression on Fail Safe and Fail Secure Outputs
- UL Listed and Tested to 294 Standard for Access Control System Units
- 3 year warranty
- BAA Compliant



PART	DESCRIPTION	LIST PRICE
PS220	2A @ 24VDC Power Supply w/ Fire Alarm Link and 0.5A auxiliary power (continuous)	\$950.00
PS220B	2A @ 24VDC Power Supply w/ Fire Alarm Link, 0.5A auxiliary power (continuous) and Battery Backup (batteries sold separately)	\$1077.00
PS440B	4A @ 24VDC Power Supply w/ Fire Alarm Link, and Battery Backup (batteries sold separately)	\$1152.00
PS480B	8A @ 24VDC Power Supply w/ Fire Alarm Link, and Battery Backup. Batteries not included (accommodates 2 ea. 7AH batteries)	\$1224.00

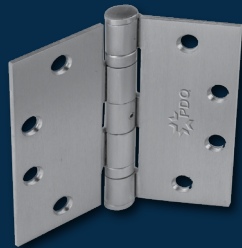

**Commercial Hinges**



**Electrified Hinges**



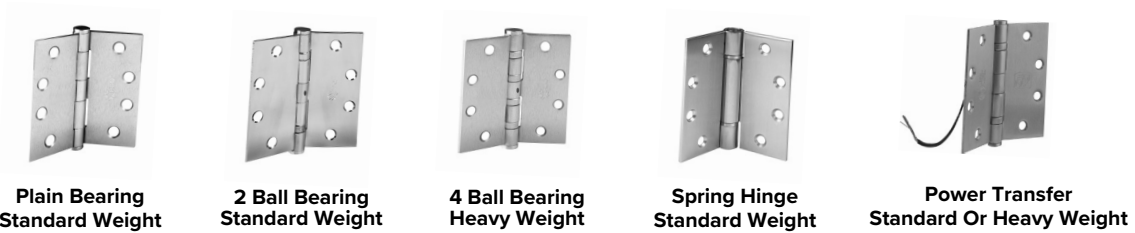

## Specifications



<b>MATERIALS:</b>	<ul style="list-style-type: none"> <li>• <b>STEEL</b> — Applications: Interior doors, non-corrosive environments.</li> <li>• <b>STAINLESS STEEL</b> — Applications: Exterior, doors, corrosive environments</li> </ul>
<b>PACKAGING:</b>	<ul style="list-style-type: none"> <li>• Qty Of Hinges Per Individual Carton: 3 ea For Plain, 2 Ball Bearing and 4 Ball Bearing Hinges 3 ea For Spring Hinges 1 ea for Electrified Hinges</li> <li>• Qty Of Hinges Per Master Carton: 48 ea For Plain, 2 Ball Bearing and 4 Ball Bearing Hinges</li> </ul>
<b>FASTENERS:</b>	<ul style="list-style-type: none"> <li>• All hinges packed with Machine Screws (12-24 x 1/2" FHMS) and Wood Screws (12 x 1-1/4" FHWS)</li> </ul>
<b>CERTIFICATIONS, LISTINGS, COMPLIANCES:</b>	<ul style="list-style-type: none"> <li>• Conforms with the requirements of NFPA 80-2010, Section 6.4.3.1.</li> <li>• Certified to ANSI/BHMA A156.1-2013: <ul style="list-style-type: none"> <li>— Grade 3, Plain Bearing (PL) 350,000 cycles</li> <li>— Electrified hinges tested to over 100,000 cycles</li> </ul> </li> <li>• UL listed: <ul style="list-style-type: none"> <li>— SH Series Spring Hinges</li> <li>— EL Series Electrified Hinges</li> </ul> </li> </ul>
<b>WARRANTY:</b>	<ul style="list-style-type: none"> <li>• Five (5) year limited warranty</li> </ul>

## Cross Reference

HINGE DESCRIPTION	PDQ	ANSI	BOMMER	HAGER	MCKINNEY	PBB	STANLEY
Plain Bearing, Standard Weight – Steel	35STPL	A8133	5000	1279	T2714	PB81	F179
				EC1100	MP79		
2 Ball Bearing, Standard Weight – Steel	35STBB	A8112	BB5000	BB1279	TA2714	BB81	FBB179
				ECBB1100	MPB79		
2 Ball Bearing, Standard Weight – Stainless Steel	35SSBB	A5112	BB5002	BB1191	TA2314	BB51	FBB191
				(630/32D)	(630/32D)		
4 Ball Bearing, Heavy Weight – Steel	35STHB	A8111	BB5004	BB1168	T4A3786	4B81	FBB168
				ECBB1102	MPB68		
4 Ball Bearing, Heavy Weight – Stainless Steel	35SSHB	A5111	BB5006	BB1199	T4A3386	4B51	FBB199
				ECBB1103	MPB68		
Spring Hinge, Self Closing – Steel	35STSH	K8107-1F	LB4310C	1250	1502	SP81	2060R
				EC1105	MPS60		

## Quick Reference Guide

PDQ HINGE MODEL*	FINISH ANSI (US)	ANSI NUMBER*	STYLE	BASE MATERIAL	SIZE	FREQUENCY	WEIGHT	THICKNESS	SWAGING
<b>FULL MORTISE HINGES</b>									
35 ST PL 4040 600	600 (P)	A8133	PLAIN	STEEL	4" x 4"	LOW		.130"±.005"	
35 ST PL 4040 652	652 (26D)								
35 ST PL 4545 600	600 (P)								
35 ST PL 4545 613	613E								
35 ST PL 4545 652	652 (26D)								
35 ST PL 4545 622	622 (US19)								
35 ST BB 4545 600 NRP	600 (P)	A8112 w/NRP	2 BALL BEARING	STEEL	4-1/2" x 4-1/2"	STANDARD		.134"±.005"	2 LEAVES
35 ST BB 4545 605 NRP	605 (3)								
35 ST BB 4545 613 NRP	613E								
35 ST BB 4545 622 NRP	622 (US19)								
35 ST BB 4545 652 NRP	652 (26D)								
35 ST BB 4540 652 NRP									
35 SS BB 4035 630 NRP	630 (32D)	A5112 w/NRP		STAINLESS STEEL	4" x 3-1/2"				
35 SS BB 4040 630 NRP					4" x 4"				
35 SS BB 4540 630 NRP					4-1/2 x 4"				
35 SS BB 4545 630 NRP									
35 SS BB 4545 622 NRP					622 (US19)				
35 ST HB 4545 600 NRP	600 (P)	A8111 w/NRP	4 BALL BEARING	STEEL	4-1/2" x 4-1/2"	HIGH	HEAVY	.180" ±.005"	
35 ST HB 4545 605 NRP	605 (3)								
35 ST HB 4545 613 NRP	613E								
35 ST HB 4545 622 NRP	622 (US19)								
35 ST HB 4545 652 NRP	652 (26D)								
35 ST HB 5045 652 NRP									
35 SS HB 4545 630 NRP	630 (32D)	A5111 w/NRP		STAINLESS STEEL	4-1/2" x 4-1/2"				
35 SS HB 5045 630 NRP					5" x 4-1/2"				
<b>SPRING HINGES</b>									
35 ST SH 4545 613	613E	K8107-1F		STEEL	4-1/2" x 4-1/2"	MEDIUM	STANDARD	.134+-.005	2 LEAVES
35 ST SH 4545 613	613E								
35 ST SH 4545 652	652 (26D)								
35 ST SH 4545 622	622 (US19)								
35 SS SH 4545 630	630(32D)	K5107-1F		STAINLESS STEEL					
<b>ELECTRIFIED HINGES</b>									
See Full Mortise Hinge Table above, 2 and 4 Ball Bearing Series.									

### How to Order



QUANTITY	SERIES	MATERIAL	STYLE	SIZE	FINISH	SECURITY FEATURE <sup>2</sup>	ELECTRIFIED OPTIONS <sup>1</sup>
10	35	ST	BB	4545	630	NRP	—
	35 — Full Mortise	ST — Steel SS — Stainless Steel	PL — Plain Bearing BB — 2 Ball Bearing HB — 4 Ball Bearing SH — Spring Hinge	4035 — 4" X 3-1/2" 4040 — 4" X 4" 4540 — 4-1/2" X 4" 4545 — 4-1/2" X 4-1/2" 5045 — 5" x 4-1/2" 5050 — 5" x 5"	600 — Prime Coated 605 — Bright Brass 613E — Dark Oxidized Satin Bronze (Equivalent) 619 — Satin Nickel 622 — Black 626 — Satin Chrome 630 — Satin Stainless Steel	NRP — Non Removable Pin	EL 4 — Concealed electric through-wire (2 wires @ 20ga, 2 wires @ 26ga) EL 8 — Concealed electric through-wire (8 wires, 28ga) EL 4 - ISMC — Concealed electric through wire with molex connector EL 8 - ISMC — Concealed electric through wire with molex connector

**4 Wire Std Weight Hinge: EL 4 35 SS BB 4545 630 NRP**







**Notes:**

- 1- EL Series only available in 2 and 4 ball bearing. Includes NRP.
- 2 - NRP standard in 2 and 4 ball bearing.





## Plain Bearing

FULL MORTISE HINGES	DESCRIPTION	QTY OF HINGES PER CARTON	FINISH ANSI (US)	PDQ HINGE MODEL	LIST PRICE PER HINGE
	5 Knuckle Base Material: Steel Size: 4" x 4" Hinge Weight: Standard Frequency of Use: Low Thickness: .130" ± .005" Certified to ANSI 8133	3ea	600 (P)	35 ST PL 4040 600	\$10.00
			652 (US26D)	35 ST PL 4040 652	
	5 Knuckle Base Material: Steel Size: 4-1/2" x 4-1/2" Hinge Weight: Standard Frequency of Use: Low Thickness: .130" ± .005" Certified to ANSI 8133	3ea	600 (P)	35 ST PL 4545 600	\$11.00
			613E	35 ST PL 4545 613	
			619(US15)	35 ST PL 4545 619	
			622 (US19)	35 ST PL 4545 622	
			652 (US26D)	35 ST PL 4545 626	





## 2 Ball Bearing

FULL MORTISE HINGES	DESCRIPTION	QTY OF HINGES PER CARTON	FINISH ANSI (US)	PDQ HINGE MODEL	LIST PRICE PER HINGE
	5 Knuckle Base Material: Stainless Steel Size: 4" x 3-1/2" Hinge Weight: Standard Frequency of Use: Medium Thickness: .118" ± .005" Certified to ANSI A5112	3ea	630 (US32D)	35 SS BB 4035 630 NRP	\$29.00
	5 Knuckle Base Material: Stainless Steel Size: 4" x 4" Hinge Weight: Standard Frequency of Use: Medium Thickness: .118" ± .005" Certified to ANSI A5112	3ea	630 (US32D)	35 SS BB 4040 630 NRP	\$32.00
	5 Knuckle Base Material: Steel Size: 4-1/2" x 4" Hinge Weight: Standard Frequency of Use: Medium Thickness: .134" ± .005" Certified to ANSI A8112	3ea	652 (US26D)	35 ST BB 4540 626 NRP	\$10.00
	5 Knuckle Base Material: Stainless Steel Size: 4-1/2" x 4" Hinge Weight: Standard Frequency of Use: Medium Thickness: .134" ± .005" Certified to ANSI A5112	3ea	630 (US32D)	35 SS BB 4540 630 NRP	\$35.00
	5 Knuckle Base Material: Steel Size: 4-1/2" x 4-1/2" Hinge Weight: Standard Frequency of Use: Medium Thickness: .134" ± .005" Certified to ANSI A8112	3ea	600 (P)	35 ST BB 4545 600 NRP	\$11.00
			605 (US3)	35 ST BB 4545 605 NRP	\$15.00
			613E	35 ST BB 4545 613 NRP	\$11.00
			619 (US15)	35 ST BB 4545 619 NRP	
			622 (US19)	35 ST BB 4545 622 NRP	
			652 (US26D)	35 ST BB 4545 652 NRP	
	5 Knuckle Base Material: Stainless Steel Size: 4-1/2" x 4-1/2" Hinge Weight: Standard Frequency of Use: Medium Thickness: .134" ± .005" Certified to ANSI A5112	3ea	622 (US19)	35 SS BB 4545 622 NRP	\$35.00
			630 (US32D)	35 SS BB 4545 630 NRP	

### 4 Ball Bearing

FULL MORTISE HINGES	DESCRIPTION	QTY OF HINGES PER CARTON	FINISH ANSI (US)	PDQ HINGE MODEL	LIST PRICE PER HINGE
	5 Knuckle Base Material: Steel Size: 4-1/2" x 4-1/2" Hinge Weight: Heavy Frequency of Use: High Thickness: .180" ± .005" Certified to ANSI 8111	3ea	600 (P)	35 ST HB 4545 600 NRP	\$26.00
			605 (US3)	35 ST HB 4545 605 NRP	\$32.00
			613E	35 ST HB 4545 613 NRP	
			619 (US15)	35 ST HB 4545 619 NRP	\$26.00
			622 (US19)	35 ST HB 4545 622 NRP	
			652 (US26D)	35 ST HB 4545 626 NRP	
	5 Knuckle Base Material: Stainless Steel Size: 4-1/2" x 4-1/2" Hinge Weight: Heavy Frequency of Use: High Thickness: .180" ± .005" Designed to meet ANSI 5111	3ea	630 (32D)	35 SS HB 4545 630 NRP	\$60.00
	5 Knuckle Base Material: Steel Size: 5" x 4-1/2" Hinge Weight: Heavy Frequency of Use: High Thickness: .180" ± .005" Designed to meet ANSI 8111	3ea	652 (US26D)	35 ST HB 5045 626 NRP	\$38.00
	5 Knuckle Base Material: Stainless Steel Size: 5" x 4-1/2" Hinge Weight: Heavy Frequency of Use: High Thickness: .180" ± .005" Designed to meet ANSI 5111	3ea	630 (32D)	35 SS HB 5045 630 NRP	\$77.00
	5 Knuckle Base Material: Stainless Steel Size: 5" x 5" Hinge Weight: Heavy Frequency of Use: High Thickness: .180" ± .005" Designed to meet ANSI 5111	3ea	630 (32D)	35 SS HB 5050 630 NRP	\$90.00



### Spring Hinges

SPRING HINGES	DESCRIPTION	QTY OF HINGES PER CARTON	FINISH ANSI (US)	PDQ HINGE MODEL	LIST PRICE PER HINGE
 	3 Knuckle Base Material: Steel Size: 4-1/2" x 4-1/2" Hinge Weight: Standard Frequency of Use: Medium Thickness: .134" ± .005" Designed to meet ANSI K8107-1F	3ea	600 (P)	35 ST SH 4545 600	\$28.00
			613E	35 ST SH 4545 613	
			619 (US15)	35 ST SH 4545 619	
			622 (US19)	35 ST SH 4545 622	
			652 (US26D)	35 ST SH 4545 626	
			605 (US3)	35 ST SH 4545 605	
 	3 Knuckle Base Material: Stainless Steel Size: 4-1/2" x 4-1/2" Hinge Weight: Standard Frequency of Use: Medium Thickness: .134" ± .005" Designed to meet ANSI K5107-1F	3ea	630 (32D)	35 SS SH 4545 630	\$64.00

### Prepackaged Hinge Sets — Everything you could need, in one convenient package.

	DESCRIPTION	FINISH	PDQ PART NUMBER	LIST PRICE PER KIT
	2-Spring Hinge 4545 1-Ball Bearing Hinge	626	35 ST SHP 4545 626	\$64.00

### Electrified Hinges

	FEATURES	QTY OF HINGES PER CARTON	CODE	DESCRIPTION	HINGE ADJUSTMENT
		1ea	EL 4	Concealed electric through-wire (2 wires @ 20ga, 2 wires @ 26ga)	\$475.00
			EL 8	Concealed electric through-wire (8 wires, 28ga)	\$550.00
			EL 4 - ISMC	Concealed electric through-wire (2 wires @ 20ga, 2 wires @ 26ga) with molex connector	\$585.00
			EL 8 - ISMC	Concealed electric through-wire (8 wires, 28ga) with molex connector	\$660.00

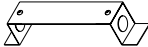
PART	DESCRIPTION	LIST PRICE
 85004	MORTAR GUARD FOR ELECTRIFIED HINGES	\$80.00



**Privacy Latches**  
SEE PAGE 228



**Flush and Surface Bolts**  
SEE PAGE 229

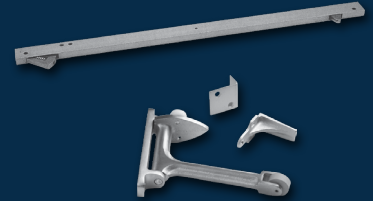

**Coordinators**  
SEE PAGE 232



**Push Plates**  
SEE PAGE 235



**Pulls and Pull Plates**  
SEE PAGE 237

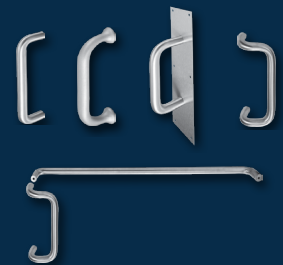

**Push and Push-Pull Bars**  
SEE PAGE 244

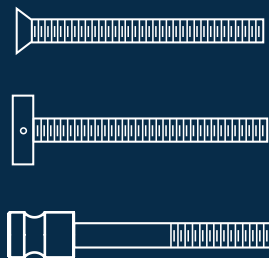

**Fasteners**  
SEE PAGE 246

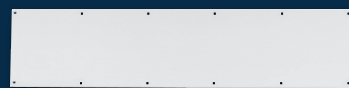

**Door Protection Plates**  
SEE PAGE 248



# Privacy Door Latch

## Great Solution for Hospitality and Dormitories



### Features



- Perfect for situations with hall-to-room openings, such as, hotels, student housing or apartments.
- Prevents accidental lock out from the conventional flip-latch.
- Allows the door to be opened for identification while providing privacy for the guest or resident.
- Keeps guest from (illegally) propping open entry fire doors.
- Does not allow the door to be held open, avoiding door and frame damage.
- Meets the requirements of FPPA 80 Sections 5.2.4.2 and 5.2.13.3 that requires auxiliary hardware does not interfere or prohibit the proper operation of fire rated doors, and that doors are not blocked or wedged in the open position.
- Easy to install, fast retrofit.
- ADA Compliant.
- Simple to operate for guest or residents.

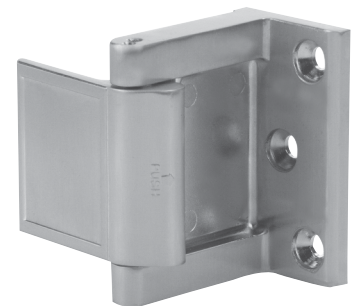



MODEL	DESCRIPTION	LIST PRICE 626
579	Privacy Door Latch	\$58.00





## Flush Bolts - Manual

MODEL (SPECIFY FUNCTION)	DESCRIPTION	LIST PRICE		
		605	613E	626
HOLLOW METAL DOOR				
 93170	Flush Bolt, ANSI Type L04251 <b>(1 ea)</b>		\$40.00	
COMPOSITE WOOD DOORS				
 93270	Flush Bolt, ANSI Type L04261 <b>(1 ea)</b>		\$48.00	

## Flush Bolts - Automatic







MODEL (SPECIFY FUNCTION)	DESCRIPTION	LIST PRICE		
		605	613E	626
HOLLOW METAL DOOR				
 93101	Flush Bolts, ANSI Type 25 <b>(Included as a Pair)</b>		\$250.00	
 93102	Flush Bolts - Push Button Release, ANSI Type 27 <b>(Included as a Pair)</b>			
 93103	Flush Bolt - with Fire Pin, ANSI Type L04021 <b>(Included as a Pair)</b>			
COMPOSITE WOOD DOORS				
 93201	Flush Bolts, ANSI Type 25 <b>(Included as a Pair)</b>		\$265.00	
 93202	Flush Bolts - Push Button Release, ANSI Type 27 <b>(Included as a Pair)</b>			
 93203	Flush Bolt - with Fire Pin, ANSI Type L04021			

# FLUSH BOLTS

## LIST PRICE

### Accessories

Effective July 3, 2023

MODEL (SPECIFY FUNCTION)	DESCRIPTION	LIST PRICE		
		605	613E	626
 99101	Includes 93101 Series Automatic Flush Bolt, for Metal Doors (Specify Finish) <b>(1 each)</b>		\$140.00	
 99102	Includes 93102 Series Top Flush Bolt w/Push Button Release (Specify Finish) <b>(1 each)</b>			
 99201	Includes 93201 Series Flush Bolt for Wood Doors (Specify Finish) <b>(1 each)</b>		\$150.00	
 99202	Includes 93202 Series Top Flush Bolt w Push Button Release for Wood Doors (Specify Finish) <b>(1 each)</b>			
 909	Dust Proof Strike (Specify Finish), <b>(1 each)</b>		\$42.00	
 629030	Fire Pin for Hollow Metal Doors and Composite Wood Doors <sup>1</sup> , <b>(1 each)</b>		\$66.00	
 93170E	24" Extension Rod for 93170 Series Manual Flush Bolts, <b>(1 each)</b>		\$15.00	

Notes: 1 - For fire labeled doors, must be used with PDQ UL fire listed automatic flush bolts to maintain UL listing status and fire code compliance.

### Cross Reference



	PDQ	ABH	DCI	HAGER	IVES	ROCKWOOD	TRIMCO
<b>DOOR TYPE</b>	<b>MANUAL FLUSH BOLTS</b>						
HOLLOW METAL	93170	1855S	780F	282D	FB458	555	3917-12
COMPOSITE WOOD	93270	1875S	790F	283D	FB358	557	3913
<b>DOOR TYPE</b>	<b>AUTOMATIC FLUSH BOLTS</b>						
HOLLOW METAL	93101	1860P	842	292D	FB31P	2842	3810x3810
	93102	—	845	293D	FB51P	2845	3820x3810
	93103	—	805/8BFB	295M	FB52	2848	3820x3850
COMPOSITE WOOD	93201	1862P	942	291D	FB41P	2942	3815x3815L
	93202	—	945	293D	FB61P	2945	3825x3815L
	93203	—	960/9BFB	295W	FB42	2948	3815x3850

# SURFACE BOLTS

## LIST PRICE

Effective July 3, 2023

### Surface Bolts

MODEL	DESCRIPTION	LIST PRICE
 460 626	Surface Bolt - 8" (Includes Top and Bottom Strikes)	\$35.00
 461 626	Surface Bolt - 12" (Includes Top and Bottom Strikes)	\$42.00
 462 626	Surface Bolt - 8" Concealed Anti-Vandal Mounting (Includes Top and Bottom Strikes)	



# ANSI Type 21A Coordinators

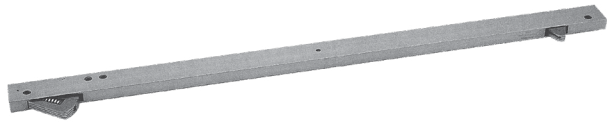

## Features

- Non-handed.
- Override protection to prevent damage in case of abnormal force on door
- Mechanism and filler bar completely fill width of opening
- Suitable for painting to match door and frame finish



## Specifications

<b>BASE MATERIAL:</b>	• Steel
<b>FASTENERS:</b>	• 8 Ea. 12-24 x 1-1/4 PH MS. • 6 Ea. #8 x 3/4" Combo Screws. • Strike Plates.
<b>FINISHES:</b>	• 600 (USP) primer
<b>COORDINATOR SIZES:</b>	• COR42: 1-5/8W" x 5/8"H x 42L" • COR52: 1-5/8W" x 5/8"H x 52L" • COR60: 1-5/8W" x 5/8"H x 60L"
<b>CERTIFICATIONS, LISTINGS, COMPLIANCES:</b>	• UL listed for 3 hours for use with a pair of swing doors incorporating an astragal • Complies with ANSI/BHMA156.3 Type 21A • TAA compliant. Country of origin: Taiwan

## How to Select the Right Size Coordinator

DOOR OPENING WIDTH	MODEL NUMBER	COORDINATOR PART NUMBER	COORDINATOR LENGTH	FILLER PART NUMBER	FILLER LENGTH
48"-54"	COORD54	COR42	42"	FB18	18"
55"-60"	COORD60	COR52	52"	FB18	18"
61"-72"	COORD72	COR52	52"	FB20	20"
73"-96"	COORD96	COR60	60"	FB36	36"

Coordinator size and length is a function of the active door size. It is recommended the coordinator extend a min of 6" beyond the active door width.

### EXAMPLES:

- 1 — Active door with astragal = 48", inactive door = 48".  
Recommended Coordinator Model: COORD96
- 2 — Active door with astragal = 36", inactive door = 36".  
Recommended Coordinator Model: COORD72
- 3 — Active door with astragal = 36", inactive door = 24".  
Recommended Coordinator Model: COORD60

NOTE: If stop height dimension is other than 58" contact PDQ Technical Service

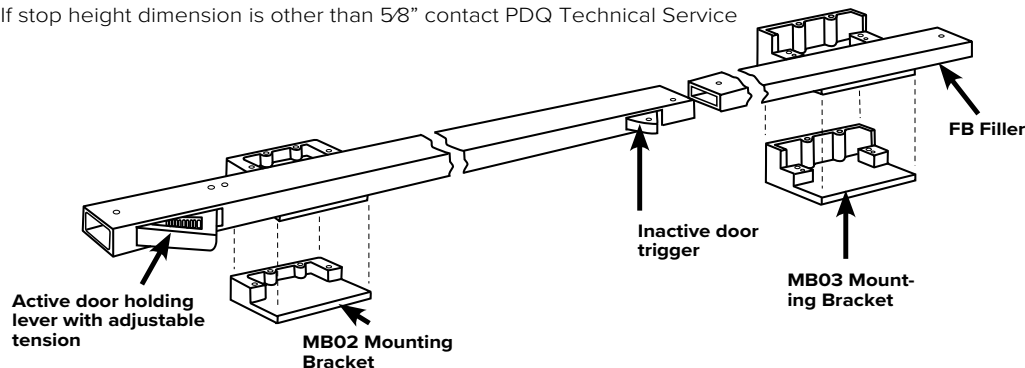
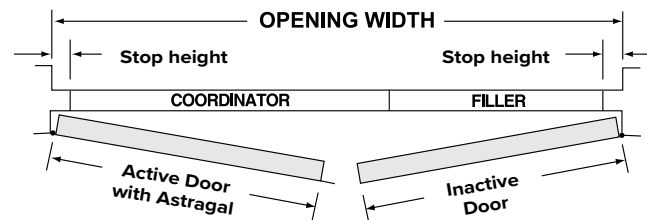

## How to Order

DOOR OPENING WIDTH	MOUNTING BRACKET OPTION	FINISH
<p><b>COORD72</b></p> <p><b>COORD 54</b> — For Door Widths From 48" - 54"  <b>COORD 60</b> — For Door Widths From 55" - 60"  <b>COORD 72</b> — For Door Widths From 61" - 72"  <b>COORD 96</b> — For Door Widths From 73 - 96"</p>	<p><b>MB02</b></p> <p><b>MB02</b> — Mounting Bracket - Soffit over 2-1/4"  <b>MB03</b> — Mounting Bracket - Soffit 7/8" - 2-1/4"</p>	<p><b>600</b></p> <p><b>600</b> — USP Primer</p>

Ordering Example Door Opening Width: 72", Soffit width: 7/8": **COORD 72 MB03 600**

MODEL	DESCRIPTION	LIST PRICE 600
	COORD 54 Door Coordinator, for door widths from 48" - 54" (Includes <b>1ea</b> FB18 18" Filler Bar)	\$240.00
	COORD 60 Door Coordinator, for door widths from 55" - 60" (Includes <b>1ea</b> FB18 18" Filler Bar)	\$268.00
	COORD 72 Door Coordinator, for door widths from 61" - 72" (Includes <b>1ea</b> FB20 20" Filler Bar)	
	COORD 96 Door Coordinator, for door widths from 73 - 96" (Includes <b>1ea</b> FB36 36" Filler Bar)	\$275.00



## Options

	CODE	DESCRIPTION	COORDINATOR ADJUSTMENT
	MB02	Mounting Bracket - Soffit over 2-1/4" <b>(Included as pair)</b>	\$75.00
	MB03	Mounting Bracket - Soffit 7/8" - 2-1/4" <b>(Included as pair)</b>	

### Accessories

PART NUMBER	DESCRIPTION	LIST PRICE 600
COR42 600	<b>COR42 Door Coordinator, 42", ANSI type 21A</b>	\$195.00
COR52 600	<b>COR52 Door Coordinator, 52", ANSI Type 21A</b>	\$210.00
COR60 600	<b>COR60 Door Coordinator, 60", ANSI type 21A</b>	\$220.00
FB18 600	<b>FB18 - Filler 18"</b>	\$28.00
FB20 600	<b>FB20 - Filler 20"</b>	\$32.00
FB36 600	<b>FB36 - Filler 36"</b>	\$40.00

### Accessories

MODEL	DESCRIPTION	LIST PRICE		
		626	689	695
 910	Carry Bar (Specify finish)	—	\$50.00	
	93590 Gravity Coordinator, 6-1/2", ANSI Type 21B	\$176.00	—	—
	93591 Gravity Coordinator, 8-1/2", ANSI Type 21B		—	—

### Cross Reference

PDQ	DESCRIPTION	ABH	DCI	HAGER	IVES	ROCKWOOD	TRIMCO
COR54	Coordinator	3710	N6	297D	COR32	2660	3094A2
COR60/72	Coordinator	3720	6	297D	COR42/52	2672	3094B1
COR96	Coordinator	3730	L-6	297D	COR60/72	2696	3094C4
MB03	Mounting Bracket	3751	601AB	297M	MB-2	1601AB	3095
MB02	Mounting Bracket	3752	601C	297N	MB-1	1601C	3096
910	Carry Bar	3760	100	297C	CB1	1100	3090
93590/93591	Gravity Coordinator	3790	500	298D	COR7G	576	3093

## Specifications



<b>MOUNTING FASTENERS:</b>	• #6 x 5/8 OH PH SMS
<b>MATERIAL:</b>	• Brass, Stainless Steel for 605, 606, 612, 613E, and 630 finishes
<b>THICKNESS:</b>	• 0.050"
<b>STANDARD CUTOUT FOR CYLINDER:</b>	• 1-1/4" DIA
<b>STANDARD CUTOUT FOR THUMBTURN:</b>	• 3/8" DIA
<b>FINISHES:</b>	<ul style="list-style-type: none"> <li>• 605 (US3) Bright Brass, 606 (US4) Satin Brass, 612 (US10) Satin Bronze, 613E Dark Oxidized Satin Bronze (Equivalent), 628 (US28) Aluminum - Anodized, 630 US32D Satin Stainless Steel</li> <li>• Antimicrobial Coating available on 630 (US32D) only</li> </ul>

Plates are available with optional cutout for cylinders or thumbturns

## OPTIONS FOR LOCKING HARDWARE

### PREPS FOR THUMBTURNS

### PREPS FOR CYLINDERS

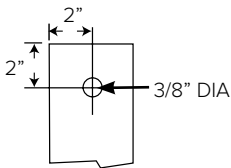

962/963 SERIES RH  
RIGHT HAND SHOWN

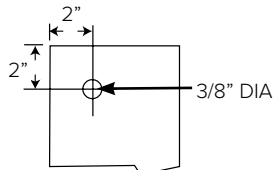
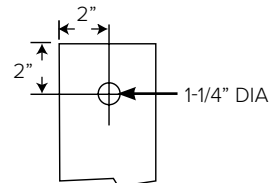

965/966 SERIES RH  
RIGHT HAND SHOWN

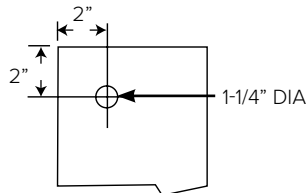

## HANDING

### IN SWING DOOR

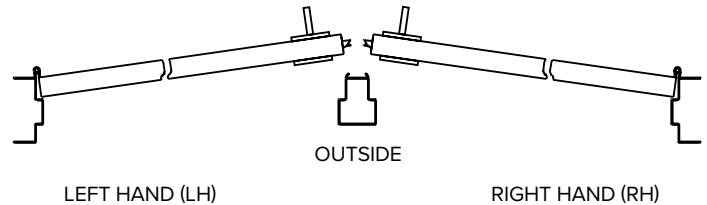

### OUT SWING DOOR

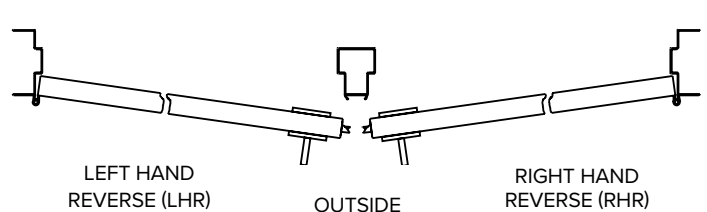

## PULL POSITIONING

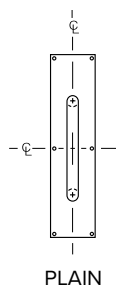

PLAIN

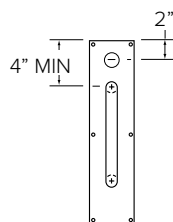

CUT

## RECOMMENDED MOUNTING LOCATIONS

Note: Complies with ADA (Americans with Disabilities Act) Guidelines

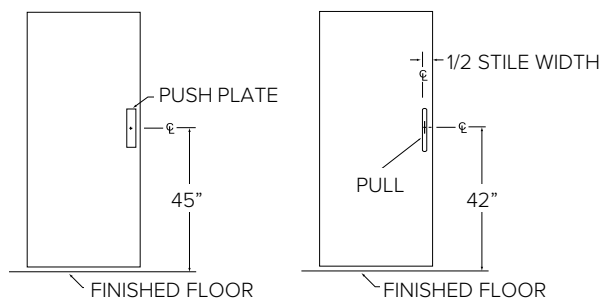

# PUSH PLATES

## LIST PRICE

Effective July 3, 2023

### How to Order

QUANTITY	SERIES	PLATE THICKNESS	SIZE	FINISH	HANDING	OPTIONS
10	9	6	2	630	RH	—
<b>Ordering Example: 9 6 2 630</b>		6 — .050"	2 — 3-1/2" X 15" 3 — 4" X 16" 5 — 6" X 16" * 6 — 8" X 16" *	605 — Bright Brass 606 — Satin Brass 612 — Satin Bronze 613E — Dark Oxidized Satin Bronze (Equivalent) 628 — Satin Aluminum, Anodized 630 — Satin Stainless Steel	RH — Right Hand LH — Left Hand	<b>CTC PREP</b> B — 5-1/2" CTC C — 6" CTC D — 8" CTC E — 10" CTC F — 12" CTC  <b>PREP FOR LOCKING HARDWARE</b> C — Cylinder T — Thumbturn  AM — Antimicrobial Coating

\* 630 Only

MODEL (Specify Finish)	DESCRIPTION	LIST PRICE					
		630	605	606	612	613E	628
962	Push Plate 0.050" thick x 3-1/2"W x 15"H	\$20.00			\$40.00		\$20.00
963	Push Plate 0.050" thick x 4"W x 16"H	\$30.00			\$50.00		\$30.00
965	Push Plate 0.050" thick x 6"W x 16"H	\$40.00			—		
966	Push Plate 0.050" thick x 8"W x 16"H	\$50.00			—		

### Options

CODE	DESCRIPTION	PLATE ADJUSTMENT
Prep for Locking Hardware		
T	Thumbturn Prep	\$8.00
C	Cylinder Prep	
CTC Thurbolt Prep (For pull plate on opposite side)		
CTC-B	5-1/2" CTC (Center to Center)	\$8.00
CTC-C	6" CTC	
CTC-D	8" CTC	
CTC-E	10" CTC	
CTC-F	12" CTC	
AM	Antimicrobial protected coating applied to tactile surfaces	\$22.00

#### Notes:

1 - Handing required for Plate Size 5 and 6. 2 - Cylinder and Thumbturn Prep not available in Plate Size 2.





## Specifications

<b>MOUNTING OPTIONS:</b>	• Varies by product, see specific product details.
<b>SIZES:</b>	• Varies by product, see specific product details.
<b>FINISHES:</b>	<ul style="list-style-type: none"> <li>• 605 (US3) Bright Brass, 606 (US4) Satin Brass, 612 (US10) Satin Bronze, 613E Dark Oxidized Satin Bronze (Equivalent), 628 (US28) Aluminum - Anodized, 630 US32D) Satin Stainless Steel, see specific product for finish availability</li> <li>• Antimicrobial Coating available on 630 (US32D) only</li> </ul>

## How to Order

PULL	FINISH	MOUNTING	OPTIONS
<b>2C</b> See Models Below  <b>Ordering Example, Standard Mount: 2C 630 1</b> <b>Notes:</b> <b>1</b> - See mounting options located on Page 239. <b>2</b> - For Mounting Option List Price Adds, see Page 246.	<b>630</b> <b>605</b> — Bright Brass <b>606</b> — Satin Brass <b>612</b> — Satin Bronze <b>613E</b> — Dark Oxidized Satin Bronze (Equivalent) <b>626</b> — Satin Chrome <b>628</b> — Satin Aluminum, Anodized <b>630</b> — Satin Stainless Steel	<b>1</b>  <b>SINGLE</b> <b>1</b> — TYPE 1 (DEFAULT) Thru Bolt for Metal, Composite or Wood Door <b>6</b> — TYPE 6 Surface Concealed for Metal Door (Door Reinforcement by Others) <b>6R</b> — TYPE 6R Surface Concealed for Metal Door (Rivnut) <b>8</b> — TYPE 8 Surface Concealed for Wood Door (Knife Thread Insert) <b>12</b> — TYPE 12 Thru Bolt for Metal, Composite or Wood Door, Decorative Head <b>15</b> — TYPE 15 Thru Bolt for Glass Door, Decorative Head  <b>BACK TO BACK</b> <b>5</b> — TYPE 5 (DEFAULT) Back to Back for Metal or Wood Door <b>13</b> — TYPE 13 Back to Back for Glass Door	—  <b>AM</b> — Antimicrobial Coating

## Straight Pulls

MODEL	DESCRIPTION	LIST PRICE					
		630	605	606	612	613E	628
 1B	5/8" Round Straight Pull 5-1/2" CTC	\$30.00		\$60.00			\$20.00
 2C	3/4" Round Straight Pull 6" CTC	\$40.00		\$70.00			\$30.00
 2D	3/4" Round Straight Pull 8" CTC	\$50.00		\$80.00			\$40.00
 3D	1" Round Straight Pull 8" CTC	\$70.00		\$100.00			\$40.00
 H3D	1" Round Straight Pull 8" CTC ADA	\$78.00	—	\$108.00	—	\$108.00	—
 H3E	1" Round Straight Pull 10" CTC ADA	\$85.00	—	—	—	—	—
 H3F	1" Round Straight Pull 12" CTC ADA	\$94.00	—	—	—	—	—
 5C	1" Flat Straight Pull 6" CTC	\$68.00		\$98.00			\$38.00
 5D	1" Flat Straight Pull 8" CTC	\$78.00		\$108.00			\$48.00

For Mounting Options, see Page 258

## Cast Pulls

MODEL	DESCRIPTION	LIST PRICE				
		605	606	612	613E	628
 11	Cast Pull 5-1/2" CTC	\$38.00				



MODEL	DESCRIPTION	LIST PRICE		
		626	605	613E
 12	Cast Pull, Surface Mount, 5-1/2" CTC	\$58.00		

## Offset Pull

MODEL	DESCRIPTION	LIST PRICE 630
 9E	1" Round Offset Pull Handle, 10" CTC	\$175.00

For Mounting Options, see Page 239

## Back to Back Pulls

MODEL	DESCRIPTION	LIST PRICE				
		630	605	606	612	613E
 22C 22D	3/4" Round Straight BTB Pull 6" CTC	\$95.00	\$125.00			
	3/4" Round Straight BTB Pull 8" CTC	\$110.00	\$140.00			
H33D	1" Round Straight BTB Pull 8" CTC ADA	\$200.00	-			
 H33E H33F	1" Round Straight BTB Pull 10" CTC ADA	\$220.00	-	-	-	-
	1" Round Straight BTB Pull 12" CTC ADA	\$245.00	-			
99E	1" Round Offset Pull Handle, 10" CTC	\$320.00	-			

For Mounting Options, see Page 258

## Options

CODE	DESCRIPTION	PULL ADJUSTMENT
AM*	Antimicrobial coating applied to tactile surfaces	\$30.00

\*Notes: - - 6 piece minimum required. Can be a mix of different products. - Orders with less than 6 pieces need to be quoted and the list price add adjusted. - Allow 2-3 weeks for delivery.

# MOUNTING OPTIONS: PULLS

**LIST PRICE**

Effective July 3, 2023

## Thru Bolt

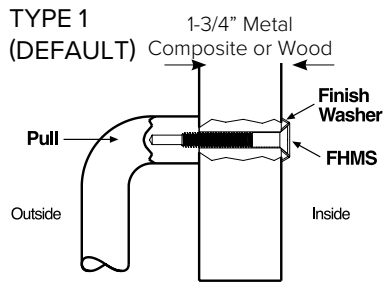

CODE	PULL ADJUSTMENT
1	N/C

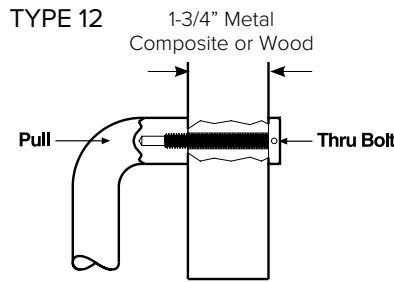

CODE	PULL ADJUSTMENT
12	\$27

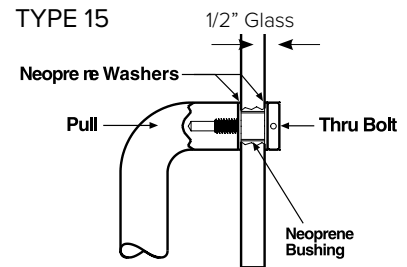

CODE	PULL ADJUSTMENT
15	\$27

## Surface Concealed

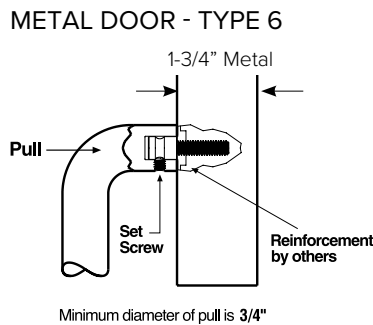

CODE	PULL ADJUSTMENT
6	\$16

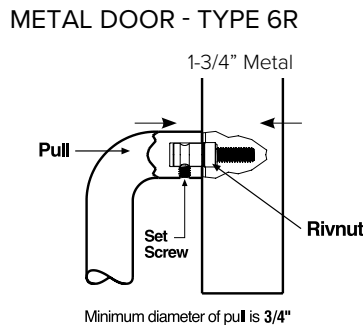

CODE	PULL ADJUSTMENT
6R	\$18

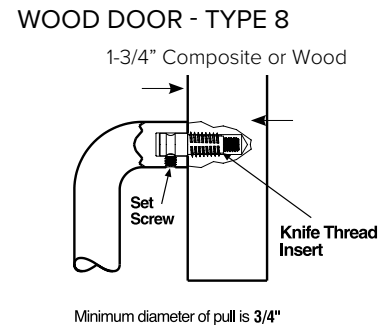

CODE	PULL ADJUSTMENT
8	\$18

## Back to Back

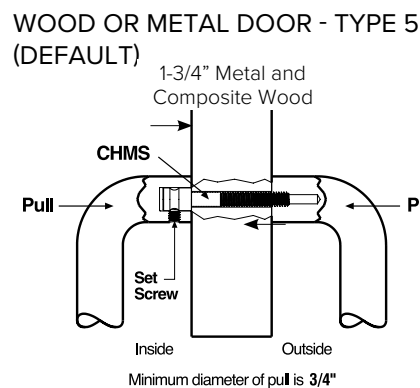

CODE	PULL ADJUSTMENT
5	N/C

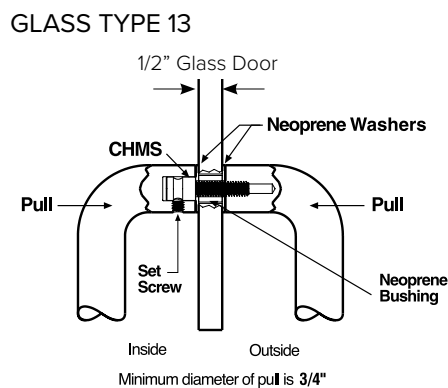

CODE	PULL ADJUSTMENT
15	\$13

# MOUNTING OPTIONS: PULLS

**LIST PRICE**

Effective July 3, 2023

## Pull Mounting Quick Reference Guide

PULL TYPE	DESCRIPTION	MOUNTING OPTIONS							
		HD*	1	5	6/6R	8	12	13	15
1B	5/8" Round Straight Pull 5-1/2" CTC		•				•		•
2C	3/4" Round Straight Pull 6" CTC		•		•	•	•		•
22C	3/4" Round Straight BTB Pull 6" CTC			•				•	
2D	3/4" Round Straight Pull 8" CTC		•		•	•	•		•
22D	3/4" Round Straight BTB Pull 8" CTC			•				•	
3D	1" Round Straight Pull 8" CTC	•	•		•	•	•		•
33D	1" Round Straight BTB Pull 8" CTC	•							
H3D	1" Round Straight Pull 8" CTC ADA	•	•		•	•	•		•
H33D	1" Round Straight BTB Pull 8" CTC ADA	•		•				•	
H3E	1" Round Straight Pull 10" CTC ADA	•	•		•	•	•		•
H33E	1" Round Straight BTB Pull 10" CTC ADA	•		•				•	
H3F	1" Round Straight Pull 12" CTC ADA	•	•		•	•	•		•
H33F	1" Round Straight BTB Pull 12" CTC ADA	•		•				•	
5C	1" 1/2 Round Straight Pull 6" CTC	•	•				•		
5D	1" 1/2 Round Straight Pull 8" CTC	•	•				•		
9E	1" Round Offset Pull Handle 10" CTC	•	•		•	•	•		•
99E	1" Round Offset Pull Handle BTB 10" CTC	•						•	
11	Cast Pull 5-1/2" CTC		•				•		

\*HD Designation indicates 5/16" fasteners for 1 inch diameter pulls

# PULL PLATES

## LIST PRICE

Effective July 3, 2023



### Specifications

<b>PLATE SIZES:</b>	• Varies by product, contact PDQ Customer Service for details.
<b>PULL SERIES:</b>	• Varies by product, see specific product details.
<b>THICKNESS:</b>	• 0.050"
<b>PLATE MOUNTING FASTENERS:</b>	• #6 X 5/8 CH PH SMS
<b>FINISHES:</b>	<ul style="list-style-type: none"> <li>• 605 (US3) Bright Brass, 606 (US4) Satin Brass, 612 (US10) Satin Bronze, 613E Dark Oxidized Satin Bronze (Equivalent), 628 (US28) Aluminum - Anodized, 630 (US32D) Satin Stainless Steel</li> <li>• Antimicrobial Coating available on 630 (US32D) only</li> </ul>





### How to Order

QUANTITY	SERIES	PLATE	PULL	FINISH	PREP FOR LOCKING HARDWARE <sup>1,2</sup>	HANDING <sup>1</sup>	MOUNTING <sup>3</sup>
10	86	3	2D	630	T	RH	1
<p>Ordering Examples: Standard mount for Metal Door: 86 3 2D 630 1</p> <p>Notes: 1 - Handing required for Plate Size 5, 6 2 - Cylinder and Thumbturn Prep not available in Plate Size 5 3 - For Mounting Options, see Page 239 4 - For Mounting Option List Price Adds, see Page 246</p>		<p><b>2</b> — 3-1/2" X 15" <b>3</b> — 4" X 16" <b>5</b> — 6" X 16" (630 ONLY) <b>6</b> — 8" X 16" (630 ONLY)</p>	<p><b>1B</b> — 5/8" Round Straight Pull 5-1/2" CTC <b>2C</b> — 3/4" Round Straight Pull 6" CTC <b>2D</b> — 3/4" Round Straight Pull 8" CTC <b>3D</b> — 1" Round Straight Pull 8" CTC <b>H3D</b> — 1" Round Straight Pull 8" CTC ADA <b>H3E</b> — 1" Round Straight Pull 10" CTC ADA <b>H3F</b> — 1" Round Straight Pull 12" CTC ADA <b>5C</b> — 1" Round Straight Pull 6" CTC <b>5D</b> — 1" Round Straight Pull 8" CTC <b>11</b> — Cast Pull 5-1/2" CTC</p>	<p><b>605</b> — Bright Brass <b>606</b> — Satin Brass <b>612</b> — Satin Bronze <b>613E</b> — Dark Oxidized Satin Bronze (Equivalent) <b>628</b> — Satin Aluminum, Anodized <b>630</b> — Satin Stainless Steel</p>	<p><b>C</b> — Cylinder <b>T</b> — Thumbturn</p>	<p><b>RH</b> — Right Hand <b>LH</b> — Left Hand</p>	<p><b>1</b> — TYPE 1 Thru Bolt for Metal, Composite or Wood Door (Default) <b>6</b> — TYPE 6 Surface Concealed for Metal Door (Door Reinforcement by Others) <b>6R</b> —TYPE 6R Surface Concealed for Metal Door (Rivnut) <b>8</b> — TYPE 8 Surface Concealed for Wood Door (Knife Thread Insert) <b>12</b> — TYPE 12 Thru Bolt for Metal, Composite or Wood Door, Decorative Head</p>

# PULLS AND PULL PLATES

## LIST PRICE

Effective July 3, 2023

SERIES	PLATE	PULL	DESCRIPTION	LIST PRICE		
				630	605/606/612/613E	628
862	 3-1/2" x 15" (Ref 962 Series Push Plate)	1B	5/8" Round Straight Pull 5-1/2" CTC	\$57.00	\$107.00	\$27.00
		2C	3/4" Round Straight Pull 6" CTC	\$65.00	\$115.00	\$35.00
		2D	3/4" Round Straight Pull 8" CTC	\$70.00	\$120.00	\$40.00
		3D	1" Round Straight Pull 8" CTC	\$105.00	\$155.00	\$75.00
		H3D	1" Round Straight Pull 8" CTC	\$113.00	\$163.00 (606/613E Only)	—
		5C	1" Flat 1/2 Round Straight Pull 6" CTC	\$97.00	\$147.00	\$67.00
		5D	1" Flat 1/2 Round Straight Pull 8" CTC	\$108.00	\$158.00	\$78.00
		11	Cast Pull 5-1/2" CTC	\$56.00	\$106.00	\$26.00
863	 4" x 16" (Ref 963 Series Push Plate)	1B	5/8" Round Straight Pull 5-1/2" CTC	\$62.00	\$112.00	\$32.00
		2C	3/4" Round Straight Pull 6" CTC	\$70.00	\$120.00	\$40.00
		2D	3/4" Round Straight Pull 8" CTC	\$80.00	\$130.00	\$50.00
		3D	1" Round Straight Pull 8" CTC	\$114.00	\$164.00	\$84.00
		H3D	1" Round Straight Pull 8" CTC	\$122.00	\$172.00 (606/613E Only)	—
		H3E	1" Round Straight Pull 10" CTC ADA	\$140.00	—	—
		H3F	1" Round Straight Pull 12" CTC ADA	\$150.00	—	—
		5C	1" Flat 1/2 Round Straight Pull 6" CTC	\$104.00	\$154.00	\$74.00
		5D	1" Flat 1/2 Round Straight Pull 8" CTC	\$105.00	\$155.00	\$75.00
		11	Cast Pull 5-1/2" CTC	\$70.00	\$120.00	\$40.00
865	 6"x16" (Ref 965 Series Push Plate)	1B	5/8" Round Straight Pull 5-1/2" CTC	—	—	—
		2C	3/4" Round Straight Pull 6" CTC	\$77.00	—	—
		2D	3/4" Round Straight Pull 8" CTC	\$89.00	—	—
		3D	1" Round Straight Pull 8" CTC	\$120.00	—	—
		H3D	1" Round Straight Pull 8" CTC	\$130.00	—	—
		H3E	1" Round Straight Pull 10" CTC ADA	\$146.00	—	—
		H3F	1" Round Straight Pull 12" CTC ADA	\$157.00	—	—
		5C	1" Flat 1/2 Round Straight Pull 6" CTC	\$109.00	—	—
		5D	1" Flat 1/2 Round Straight Pull 8" CTC	\$120.00	—	—
		11	Cast Pull 5-1/2" CTC	\$74.00	—	—
866	 8"x16" (Ref 866 Series Push Plate)	2D	3/4" Round Straight Pull 8" CTC	\$98.00	—	—
		3D	1" Round Straight Pull 8" CTC	\$125.00	—	—
		H3D	1" Round Straight Pull 8" CTC	\$135.00	—	—
		H3E	1" Round Straight Pull 10" CTC ADA	\$154.00	—	—
		H3F	1" Round Straight Pull 12" CTC ADA	\$165.00	—	—
		5C	1" Flat 1/2 Round Straight Pull 6" CTC	\$114.00	—	—
		5D	1" Flat 1/2 Round Straight Pull 8" CTC	\$125.00	—	—

For Mounting Options, see Page 264.

### Options – Locking Hardware Prep

CODE	DESCRIPTION	PULL PLATE ADJUSTMENT
T	Locking Hardware – Thumbturn Prep	\$8.00
C	Locking Hardware – Cylinder Prep	
AM*	Antimicrobial protected coating applied to tactile surfaces	\$30.00

**Note: 630 finish only, please place antimicrobial coated orders separately, and allow 30 days for manufacturing.**

**For additional product finishes or styles, please contact PDQ Technical Service.**

91 00 33 Series Push Bar

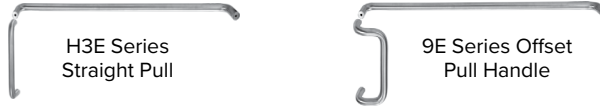

## How to Order

QUANTITY	SERIES	PULL	PUSH BAR	FINISH	MOUNTING OPTIONS, PUSH BAR ONLY	MOUNTING OPTIONS, OFFSET PULL AND PUSH BAR SET
10	91	9E	33	630	—	S
Ordering Examples: Push Bar Only, Thru Bolt Mounting: 91 00 33 630 1HD  Offset Pull Handle Push-Bar Set, Standard Mounting: 91 9E 33 630 S		<b>00</b> — No Pull <b>3D</b> — 1" Round Straight Pull 8" CTC <b>H3D</b> — 1" Round Straight Pull 8" CTC ADA <b>H3E</b> — 1" Round Straight Pull 10" CTC ADA <b>H3FÆ</b> — 1" Round Straight Pull 12" CTC ADA <b>9E</b> — 1" Round Offset Pull Handle	<b>XX</b> — 1" Round Push Bar, Xx" CTC Example: <b>33</b> — 1" Round Push Bar, 33" CTC	<b>630</b> — Satin Stainless Steel <b>630AM</b> — Satin Stainless Steel With Antimicrobial	<b>1</b> — Type 1 (Default) Thru Bolt For Metal, Composite Or Wood Door <b>6</b> — Type 6 Surface Concealed For Metal Door (Door Reinforcement By Others) <b>6R</b> — Type 6R Surface Concealed For Metal Door (Rivnut) <b>8</b> — Type 8 Surface Concealed For Wood Door (Knife Thread Insert) <b>12</b> — Type 12 Thru Bolt For Metal, Composite Or Wood Door <b>15</b> — Type 15 Thru Bolt For Glass Door, Decorative Head	<b>S</b> — Standard (Default) <b>D</b> — Decorative <b>M</b> — Concealed For Metal Doors <b>W</b> — Concealed For Composite Or Wood Doors <b>G</b> — Decorative For Glass Doors
SEE PAGE 264 FOR MOUNTING OPTION PRICING						

## Push Bars

MODEL	DESCRIPTION	LIST PRICE 630	PUSH BAR ADJUSTMENT
 91 00 33	1" Round Push Bar, Including 33" CTC	\$320.00	—
	1" Round Push Bar, Over 33" CTC		\$15.00 per inch
 91 91 33	1" Round Push Bar BTB	\$645.00	\$30.00 per inch

## Push-Pull Bars

MODEL	DESCRIPTION	LIST PRICE 630
 3D	1" Round Straight Pull 8" CTC	\$105.00
 H3D H3E H3F	1" Round Straight Pull 8" CTC ADA	\$115.00
	1" Round Straight Pull 10" CTC ADA	\$125.00
	1" Round Straight Pull 12" CTC ADA	\$135.00
	9E	1" Round Offset Pull, 10" CTC ADA

For Mounting Options, see Page 264



# PUSH AND PUSH-PULL BARS

**LIST PRICE**

Effective July 3, 2023

## Free End Details

### Thru Bolt

TYPE 1

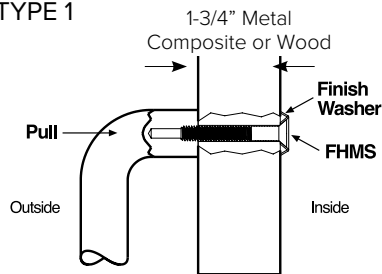

TYPE 12

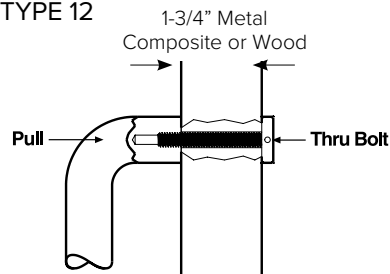

TYPE 15

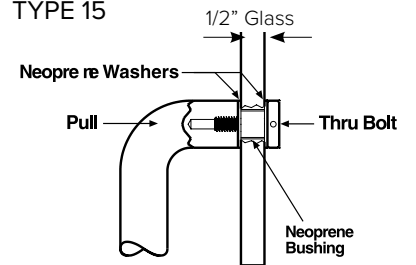

### Surface Concealed

TYPE 6

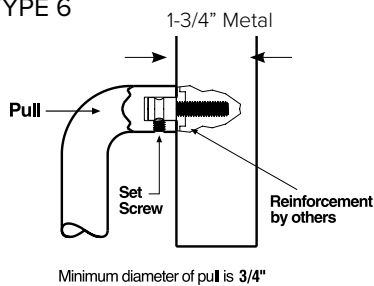

TYPE 6R

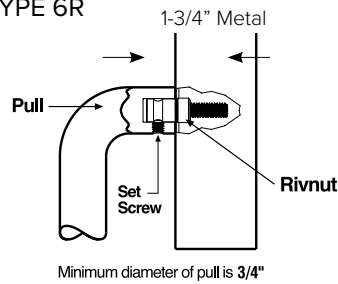

TYPE 8

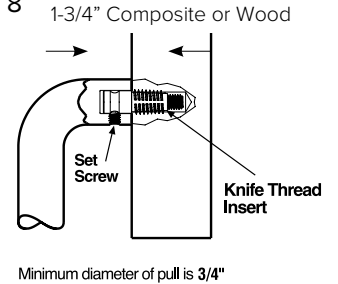

### Common End Details

TYPE 5

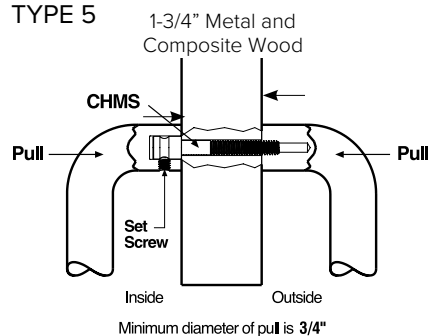

TYPE 13

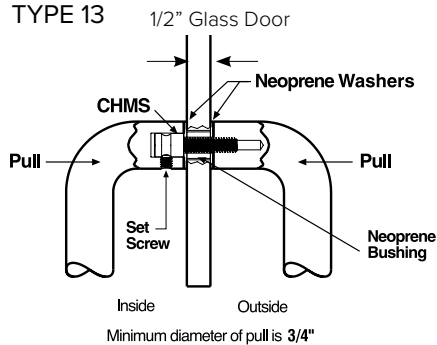

Note: For measurement details see brochure

### Options – Mounting for Offset Pull Handles – Push Bar Sets

TYPE	DESCRIPTION	MOUNTING TYPES		ADJUSTMENT
		COMMON END	FREE END	
S	Std Thru Bolt For 1-3/4" Metal, Composite or Wood Doors (Default)	5	1	N/C
D	Decorative Thru Bolt for 1-3/4" Metal, Composite or Wood Doors	5	12	\$30.00
M	Concealed for 1-3/4" Metal Doors	5	6	\$25.00
W	Concealed for 1-3/4" Composite or Wood Doors	5	8	\$30.00
G	Decorative Thru Bolt for 1/2" Glass Doors	13	15	\$25.00

## Screw Types

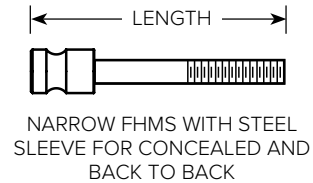
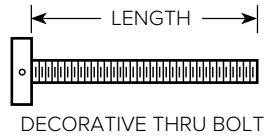
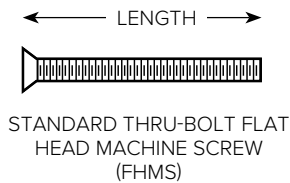

## Fasteners for Door Pulls

Note: Fastener packs for 1-3/4" Steel and Composite Wood or 1/2" Thick Glass Doors. For other door thickness applications, contact PDQ Technical Service.

PART NUMBER (Specify Finish)	OPTIONS, MOUNTING TYPE	DESCRIPTION	LIST PRICE 605, 613E, 630	
9001	1	2 ea. 1/4-20 x 2-1/4" FH MS, 2 ea. 1/4" Finish Washers.	\$8.00	
	HD	2 ea. 5/16-18 x 2-1/4 FH MS, 2 ea. 5/16" Finish Washers.		
9005	5W	2 ea. 1/4-20 x 2-3/4" Undersize Head FH MS, 2 ea. 1/4-20 x 3/16" Set Screws, 2 ea. 1/4" x 1/2" Tapered Steel Sleeves, 2 ea. 1/4-20 x 1/2" Threaded Insert.	\$24.00	
	HD	2 ea. 5/16-18 x 2-3/4" Undersize Head FH MS, 2 ea. 1/4-20 x 1/4" Set Screws, 2 ea. 5/16" x 1/2" Steel Sleeves, 2 ea. 1/4-20 x 1/2" Threaded Insert.		
9006	6	2 ea. 1/4-20 x 1" Undersize Head FH MS, 2 ea. 2 ea. 1/4-20 x 3/16" Set Screws, 2 ea. 1/4" x 1/2" Tapered Steel Sleeves.		
	HD	2 ea. 5/16-18 x 1" Undersize Head FH MS, 2 ea. 1/4-20 x 1/4" Set Screws, 2 ea. 5/16" x 1/2" Tapered Steel Sleeves.		
9006R	6R	2 ea. 1/4-20 x 1-3/4" Undersize Head FH MS, 2 ea. 1/4-20 x 3/16" Set Screws, 2 ea. 1/4" x 1/2" Tapered Steel Sleeves, 2 ea. 1/4-20 Rivnut Inserts.		
	HD	2 ea. 5/16-18 x 1-5/8 Undersize Head FH MS, 2 ea. 1/4-20 x 1/4" Set Screws, 2 ea. 5/16" x 1/2" Tapered Steel Sleeves, 2 ea. 5/16-18 Rivnut Inserts		
9008	8	2 ea. 1/4-20 x 1-5/8" Undersize Head FH MS, 2 ea. 1/4-20 x 3/16" Set Screws, 2 ea. 1/4" x 1/2" Tapered Steel Sleeves, 2 ea. 1/4 - 20 Knife Thread Inserts		
	HD	2 ea. 5/16-18 x 1-5/8 Undersize Head FH MS, 2 ea. 1/4-20 x 3/16" Set Screws, 2 ea. 5/16" x 1/2" Tapered Steel Sleeves, 2 ea. 5/16 - 18 Knife Thread Inserts.		
9012	12	2 ea. 1" DIA Head, 1/4-20 x 2-1/4" Decorative Cap Bolts.		\$34.00
	HD	2 ea. 1" DIA Head, 5/16-18 x 2-1/4" Decorative Cap Bolts.		
9013	13	2 ea. 1/4-20 x 1-3/4" Undersize Head FH MS, 2 ea. 1/4-20 x 3/16" Set Screws, 2 ea. 1/4" x 1/2" Tapered Steel Sleeves, 2 ea. Bushings for 1/2" Thick Glass Door, 4 ea. Neoprene Washer.	\$38.00	
	HD	2 ea. 5/16-18 x 1-3/4" Undersize Head FH MS, 4 ea. 1/4-20 x 1/4" Set Screws, 2 ea. 5/16" x 1/2" Tapered Steel Sleeves, 2 ea. Bushings for 1/2" Thick Glass Door, 4 ea. Neoprene Washers.		
9015	15	2 ea. 1" DIA Head 1/4-20 x 1-1/8" Decorative Cap Bolts, 2 ea. Neoprene Bushings for 1/2" Thick Glass Door, 4 ea. Neoprene Washers.	\$55.00	
	HD	2 ea. 1" DIA Head 1/4-20 x 1-1/8 Decorative Cap Bolts, 2 ea. Neoprene Bushings for 1/2" Thick Glass Door, 4 ea. Neoprene Washers.		

Ordering example: 9001 HD-630. . HD is for 1" pulls

## Types

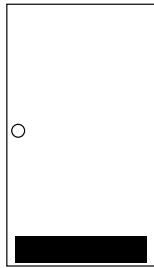

**MOP PLATE**  
UP TO 6" H  
X 48" W

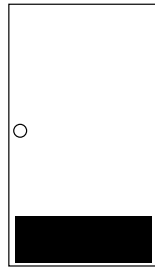

**KICK PLATE**  
6" TO 12" H  
X 48" W

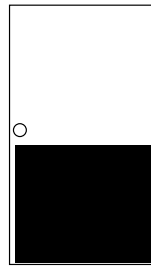

**ARMOR PLATE**  
UP TO 48" H  
X 48" W AND  
AVAILABLE IN  
MOST FINISHES

## Features

- All PDQ door protection plates receive a light bevel in a secondary process to ensure a smooth edge.
- Provides protection for the bottom of the door from scuffing due to the foot traffic or cleaning maintenance.
- Recommended for all doors especially when using a door closer.
- Standard oval head undercut screws create a countersunk appearance.

## Specifications

<b>MATERIAL:</b>	• Stainless Steel
<b>THICKNESS:</b>	• 0.050"
<b>MOUNTING FASTENERS:</b>	• #6 x 5/8 OH PH SMS
<b>FINISHES:</b>	• 630 (US32D) Satin Stainless Steel, 613E , 622(US19)

## How to Order

QUANTITY	SERIES	HEIGHT	WIDTH	FINISH
10	980	06	34	630
<b>Ordering Example:</b>		EXAMPLES: 06 — 6" 10 — 10"	EXAMPLES: 34 — 34" 35 — 35"	613E — Dark Oxidized Satin Bronze (Equivalent) 622 — Flat Black 630 — Satin Stainless Steel

### Mop, Kick, and Armor Plates

DIMENSIONS	630	613E/622
6" x 34"	\$75.00	\$94.00
8" x 34"	\$111.00	\$139.00
10" x 34"	\$133.00	\$166.00
12" x 34"	\$152.00	\$190.00
32" x 34"	\$462.00	\$578.00
34" x 34"	\$490.00	\$613.00
36" x 34"	\$550.00	\$688.00
6" x 35"	\$88.00	\$110.00
8" x 35"	\$115.00	\$144.00
10" x 35"	\$139.00	\$174.00
12" x 35"	\$172.00	\$215.00
32" x 35"	\$473.00	\$591.00
34" x 35"	\$520.00	\$650.00
36" x 35"	\$578.00	\$723.00



**Wall Stops  
and Holders**



**Floor Stops  
and Holders**



**Kick Down Door  
Stops**



**Hinge Stops**



**Roller Stops**

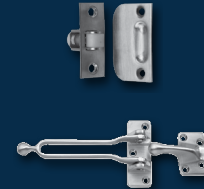











**Roller Latches,  
Catches and  
Protectors**



**Hooks, Silencers,  
Door Viewers and  
Strikes**





## Wall Stops and Holders

MODEL (SPECIFY FUNCTION)	DESCRIPTION	QTY PER BOX	LIST PRICE					
			605	613E	619	625	626	630
 101	Wall Stop - Convex Bumper ANSI Type L02101	50	\$8.00					
 102	Wall Stop - Concave Bumper ANSI Type L02251	50						
 106	Wall Stop - Adhesive Backed	50	\$3.00					
 107	Door Stop - Heavy Duty ANSI Type L02021	5	\$32.00	—	—	\$32.00	—	
 108	Door Stop - Heavy Duty with Keeper ANSI Type L01351	5	\$42.00	—	—	\$42.00	—	
 109	Door Stop ANSI Type L02031	5	\$13.00	—	—	—	\$13.00	
 110	Door Stop - Aluminum ANSI Type L02031	15	\$8.00					—
 112	Door Stop - Spring Base ANSI Type L02051	100	\$3.00			—	—	—
 115	Angled Wall Stop ANSI Type L02051	20	—	—	—	—	\$55.00	
 119	Door Holder with Stop	20	—	—	—	—	\$80.00	

## Floor Stops and Holders

MODEL (SPECIFY FUNCTION)	DESCRIPTION	QTY PER BOX	LIST PRICE			
			605	613E	625	626
 220	Universal Dome Stop ANSI Type L02141 for plastic anchors ANSI Type L20161 for lead anchors	20	—	—	—	\$15.00
 221	Floor Stop - Low Dome ANSI Type L02141	50	\$12.00			
 222	Floor Stop - High Dome ANSI Type L02061	50	\$14.00			
 223	Floor Stop - Riser ANSI Type L02141	50	—	—	—	\$6.00
 224	Floor Stop - Offset ANSI Type L02181	10	—	\$28.00	—	\$28.00
 225	Floor Stop - Offset ANSI Type L02181	10	—	\$32.00	—	\$32.00
 226	Floor Stop - Offset with Hold Open ANSI Type L01371	5	—			
 227	Floor Stop ANSI Type L02131	5	\$34.00		—	\$34.00
 228	Floor Stop - with Keeper ANSI Type L01371	5	\$36.00		—	\$36.00
 229	Stop ANSI Type L02131	10				
 230	Stop ANSI Type L02131	10				
 231	Floor Stop, Low Profile	25	\$18.00		—	\$18.00
 232	Floor Stop	25	\$20.00		—	\$20.00
 233	Floor Stop ANSI Type L02131	10	—	—	—	



## Kick Down Door Stops

MODEL (SPECIFY FINISH)	DESCRIPTION	QTY PER BOX	LIST PRICE				
			605	613E	626	689	695
 240	Kick Down - 4" ANSI Type L01382	10	—	—	—	\$18.00	
 241	Kick Down - 5" ANSI Type L01382	10	—	—	—	\$20.00	
 242	Kick Down - 4" ANSI Type L01382	10	\$24.00			—	—
 243	Kick Down - 5" ANSI Type L01382	10	\$32.00			—	—

## Hinge Stops

MODEL (SPECIFY FINISH)	DESCRIPTION	QTY PER BOX	LIST PRICE				
			605	613E	626	689	695
 245	Hinge Stop - 5" ANSI Type L02223	100	\$6.00			—	—



## Roller Stops

MODEL (SPECIFY FINISH)	DESCRIPTION	QTY PER BOX	LIST PRICE				
			605	613E	626	689	695
 350	Roller Stop, 4-1/2" ANSI Type L02191	10	\$26.00			—	—
 351	Roller Stop, 6-1/2" ANSI Type L02201	10	\$38.00			—	—
 352	Roller Stop, Curved ANSI Type L02211	10	\$40.00			—	—



## Roller Latches, Catches and Protectors

MODEL (SPECIFY FINISH)	DESCRIPTION	QTY PER BOX	LIST PRICE				
			605	613E	626	689	695
 571	Roller Latch with T Strike ANSI Type E09101	5	\$32.00			—	—
 572	Roller Latch with ASA Strike	5	\$36.00			—	—
 573	Roller Latch with Full Lip Strike	5				—	—
 574	Roller Latch with Angle Stop ANSI Type E09111	10	—	—	\$64.00	—	—
 575	Roller Latch with Strike	10	\$16.00			—	—
 577	Ball Catch Adjustable	10				—	—
 578	Door Guard	10	\$38.00			—	—
 579	Privacy Door Latch	10	—	\$58.00		—	—
 582	Latch Protector	20	—	—	—	\$17.00	
 583	Latch Protector with 3-3/8" DIA Notched	20	—	—	—		
 584	12" Interlock Latch Protector	20	—	—	—	\$14.00	

## Hooks

MODEL (SPECIFY FINISH)	DESCRIPTION	QTY PER BOX	FINISH N/A	LIST PRICE			
				605	613E	625	626
 901	Coat Hook - Medium ANSI Type L03111	10	—	—	—	—	\$14.00
 902	Wardrobe Hook - Small ANSI Type L03111	10	—	—	—	—	



## Silencers

MODEL	DESCRIPTION	QTY PER BOX	LIST PRICE
 904	Silencer - Metal Doors (Must be ordered in multiples of 100.) ANSI Type L03011	100	\$18.00
 905	Silencer - Wood Doors (Must be ordered in multiples of 100.) ANSI Type L03021	100	

## Door Viewers

MODEL (SPECIFY FINISH)	DESCRIPTION	QTY PER BOX	FINISH N/A	LIST PRICE		
				605	613E	626
 906	Door Viewer - 160 degrees UL ANSI Type 03222	25	—	\$16.00		

## Strikes

MODEL (SPECIFY FINISH)	DESCRIPTION	QTY PER BOX	FINISH N/A	LIST PRICE			
				605	613E	625	626
 909	Dust Proof Strike (Specify Finish), <b>1 each</b>	—	—	\$42.00	—	—	\$42.00
 95572	Strike, Roller Latch - ASA	25	—	\$16.00	—	—	\$16.00
 95673	Strike, Roller Latch - Full Lip	50	—		—	—	





# Sliding Barn Door Hardware



Architecturally Designed for Hospitality, Multi-Family and Commercial Applications.

## Features

- Exclusive Soft Close stop design. Specify option SC.
- Max door weight: 220 lbs
- Nylon coated rollers
- Grade 304 Stainless Steel components
- Finish: 630 satin stainless steel

## Specifications

<b>CONFIGURATIONS:</b>	<ul style="list-style-type: none"> <li>• Single</li> <li>• Bi-parting</li> </ul>
<b>INSTALLATION:</b>	<ul style="list-style-type: none"> <li>• Side Wall Mount (only)</li> </ul>
<b>PERFORMANCE:</b>	<ul style="list-style-type: none"> <li>• Meets ANSI 156.14 Grade 1 Standard (100,000 cycles)</li> </ul>
<b>STANDARD KIT INCLUDES:</b>	<ul style="list-style-type: none"> <li>• 1 ea Track (specify length)</li> <li>• 2 ea Wall Brackets</li> <li>• 2 ea Track Stops</li> <li>• 2 ea Top Mount Hangers with Anti-jump pins</li> <li>• 1 ea Wood Guide</li> <li>• Installation fasteners</li> </ul>



## Cross Reference

PDQ	HAFELE	HAGER	PEMKO
<b>STS SERIES</b>	FLATEC II SERIES	9432 SERIES	W60 SERIES
<b>STS WITH SOFT CLOSE</b>	N/A	N/A	W60 WITH CUSHION STOP



# SLIDING BARN DOOR HARDWARE — LIST PRICE

Effective July 3, 2023

## How to Order

QUANTITY	SERIES	DOOR MATERIAL	HANGER TYPE	TRACK (SPECIFY LENGTH)	FINISH	OPTIONS
10	STS	W	171	78	630	—
	STS — SLIDING TRACK SYSTEM	W — WOOD	171 — TOP MOUNT, SINGLE ROLLER	78 — 78-3/4" FOR 36" WIDE DOOR 98 — 98-7/16 " FOR 48" WIDE DOOR	630 — SATIN STAINLESS STEEL	SC — SOFT CLOSE







Ordering Examples: Kit for Wood Door: STS W 171 78 630 / Kit for Wood Door with Soft Close: STS W 171 78 630 SC

MODEL	DESCRIPTION	LIST PRICE
STS W 171 78 630	Sliding Barn Door Hardware for 36" Wood Door,	\$615.00
STS W 171 98 630	Sliding Barn Door Hardware for 48" Wood Door,	\$690.00

## Options

CODE	DESCRIPTION	HARDWARE ADJUSTMENT
STS-W-171-78-630-SC	Soft Close (Extended lead time: Consult factory for lead times)	\$150.00
STS-W-171-98-630-SC	Soft Close (Extended lead time: Consult factory for lead times)	

## Accessories

PART NUMBER	DESCRIPTION	LIST PRICE
STSP17101-630 	STOP	\$22.00 each
STSP17103-630 	TOP MOUNT ROLLER HANGER. INCLUDES INSTALLATION FASTENERS.	\$90.00 each
STSP17104-630 	SOFT CLOSE ASSEMBLY	\$46.00 each
STSP17105-630 	SOFT CLOSE TRIGGER BRACKET. INCLUDES INSTALLATION FASTENERS.	\$18.00 each
STSP17106-630 	FLOOR GUIDE. INCLUDES INSTALLATION FASTENERS.	
STSP17107-630 	BI-PARTING CONNECTOR MATERIAL: GRADE 304 STAINLESS STEEL FINISH: 630 STAINLESS STEEL. MATCHES RAIL FINISH. "O" RINGS MAKE FOR EASY INSERTION INTO TRACK AND HELPS DAMPEN UNWANTED VIBRATION NOISE.	\$35.00 each

## Bi-Parting Solutions

FOR OPENINGS UP TO 4 FT WIDE:

- Requires: — 1ea STS Series Track Assy
- 2ea STSP17103-630 Roller Assemblies
- 2ea STSP7101-630 Stops
- 1ea STSP17106-630 Floor Guide

FOR OPENINGS OVER 4 FT WIDE:

- Requires: — 2ea STS Series Track Assys (specify size)
- 1ea STSP17107-630 Bi-parting Connector

BI-PARTING CONNECTOR



Note: Refer to Installation Instructions

Note: Refer to Installation Instructions

# Master Key System Design

## 2- Levels of keying

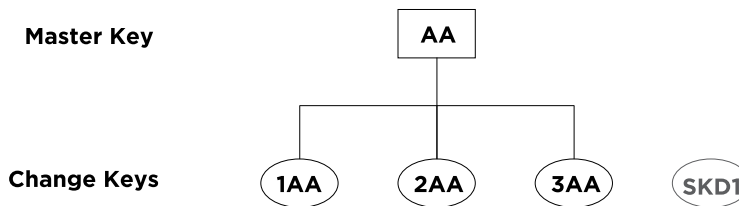

## 3- Levels of keying

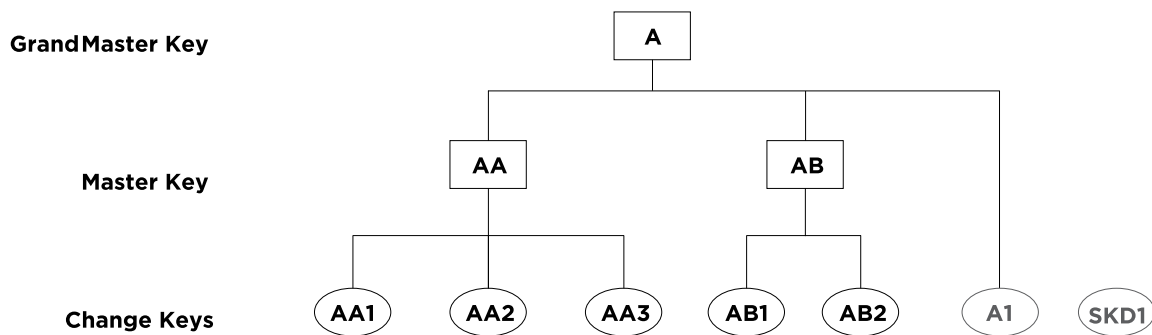

## 4- Levels of keying

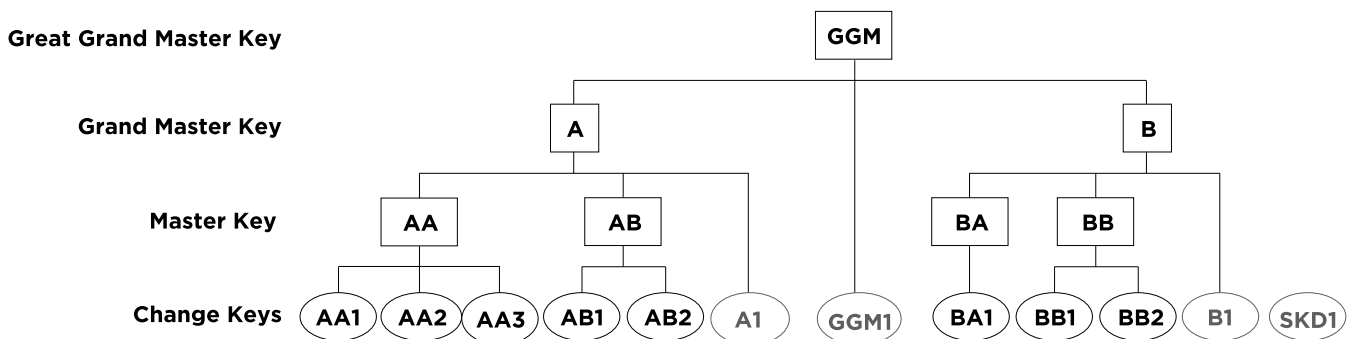



# PDQ Keying System Worksheet

Job Reference \_\_\_\_\_  
 Information \_\_\_\_\_  
 Date \_\_\_\_\_ By \_\_\_\_\_  
 Approved By \_\_\_\_\_  
 Date \_\_\_\_\_

Grand Master Key
Area/Dept

**Instructions:** Indicate the highest level master key symbol in the top line of each box. Identify the area or department, indicate the total number of key changes, including future expansion. Do not use letters I, O, or Q in key symbols.

Page  of

Selective \_\_\_\_\_ Control Key  Used with IC cores only  
 Master Key \_\_\_\_\_ CMK  Construction Master Keying

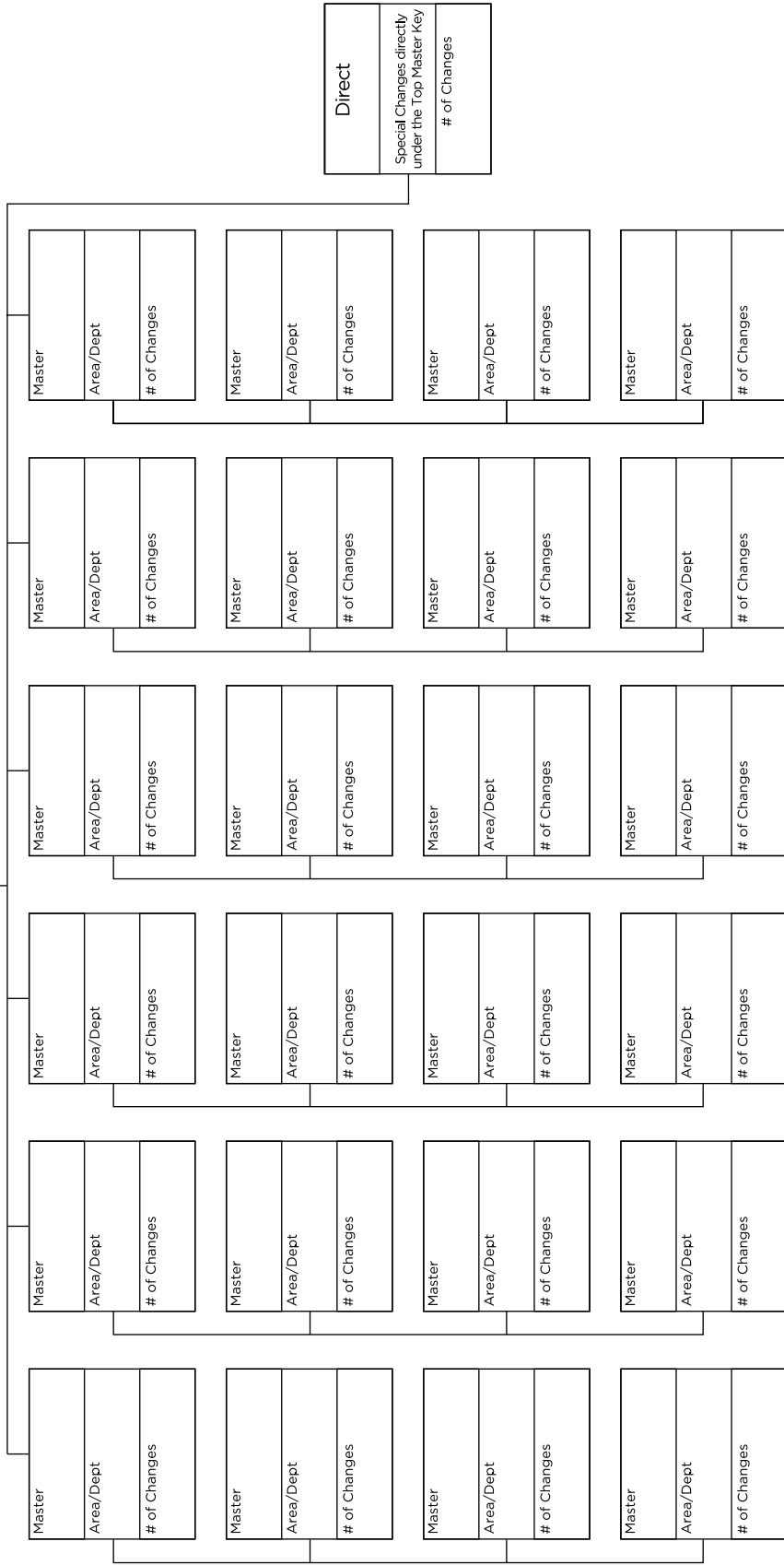

Single Keyed Changes

SKD
Door# or Area

SKD
Door# or Area

SKD
Door# or Area

Special Instructions

---



---



---

Change key only, will not be operated by any other key within the system



# Finishes

PDQ Manufacturing finishes are durable, top-quality finishes obtained by the processing of solid brass, bronze, stainless steel and other materials. It is important that usage, climate and other conditions be taken into consideration when selecting finishes. This is especially true in areas subjected to corrosive vapors, humid climate or sea air, which in short time may have a damaging effect on finishes. To preserve appearance, cleaning and care may be required. Non-clear coated finishes should not be cleaned with soap or solvents; organically coated surfaces should be cleaned periodically with mild, non-abrasive soap and buffed lightly with a clean cloth. Contact PDQ technical service for recommendations on the care of finished hardware.

BHMA symbols and U.S. Code Designations (noted below in parentheses) are used in some cases to indicate the similarity of finish appearance, regardless of the base material.

PDQ strives to stock all finishes shown in this price book for immediate shipment ( 1-2 days, less keying). However, we suggest you contact the factory to confirm availability for large jobs.

**Refer to Each Lock Series Section for Standard Finish Availability.**

## Architectural



605 (US3)  
Bright Brass



606 (US4)  
Satin Brass



612 (US10)  
Satin Bronze



613E  
Dark Oxidized Satin  
Bronze (Equivalent)



619 (US15)  
Satin Nickel

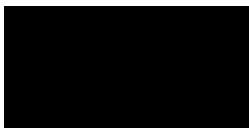

622 (US19)  
Flat Black



625 (US26)  
Bright Chromium



626 (US26D)  
Satin Chromium



628 (US28)  
Satin Aluminum



629 (US32)  
Bright Stainless Steel



630 (US32D)  
Satin Stainless Steel



652 (US26D)  
Satin Chromium

## Painted



689 (US28)  
Aluminum



693  
Black



695  
Dark Duranodic  
Bronze



696 (US4)  
Satin Brass (Gold)

Finishes shown are representative only. PDQ cannot guarantee that product shipped will match finishes shown.  
Not all products are available in all finishes listed.

# Lock Handing

## What is Lock Handing?

The handing of a lock is important in order to ensure that the correct side of the door is secure, the levers are oriented properly, and that the door closes properly.

There are 2 parts to a door and lock handing, the handing (left or right) and the swing of the door (whether it is reversed or standard). There are 4 different lock handings; left hand (LH), right hand (RH), left-hand reverse (LHR), and right-hand reverse (RHR).

There are many ways to determine handing however PDQ recommends the following method:

- Stand on the outside (secure side) of the door
- Note the location of the hinges, not the lock
- If the hinges are on the left, it's a left-hand door
- If the hinges are on the right, it's a right-hand door
- Next note if the door swings toward you or away from you
- If the door swings away from you, it's a standard swing door
- If the door swings towards you, it's a reverse bevel door

See the illustration below for examples of how to determine the door handing you need when placing your PDQ order.

## How to Determine Hand of Door

### In Swing Door

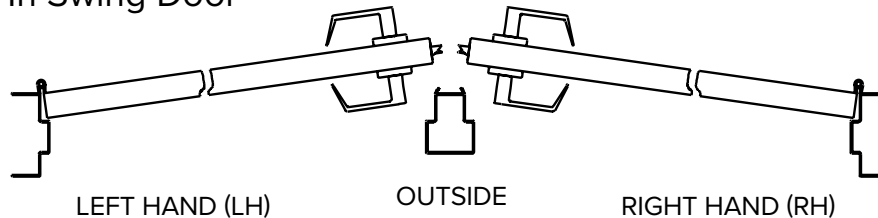

### Out Swing Door

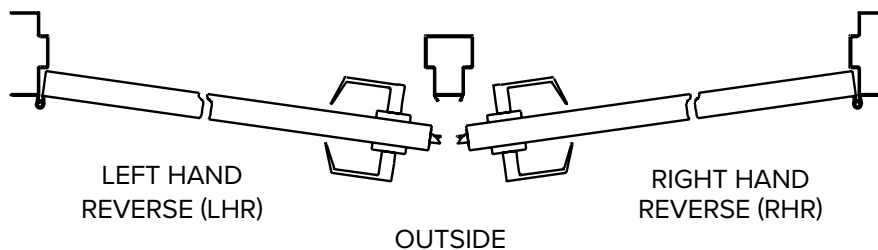



## Weight Chart

<b>Locksets*</b>			
<i>Item</i>	<i>Function</i>	<i>Case Quantity</i>	<i>Average Weight/Case (lbs.)**</i>
<i>MR (Rose)</i>	<i>Entrance</i>	<i>6</i>	<i>45</i>
<i>MR (Escutcheon)</i>	<i>Entrance</i>	<i>6</i>	<i>46</i>
<i>XGT</i>	<i>Entrance</i>	<i>6</i>	<i>33</i>
<i>GT</i>	<i>Entrance</i>	<i>6</i>	<i>33</i>
<i>GP</i>	<i>Entrance</i>	<i>6</i>	<i>30</i>
<i>SD</i>	<i>Entrance</i>	<i>10</i>	<i>37</i>
<i>SX Ball</i>	<i>Entrance</i>	<i>10</i>	<i>32</i>
<i>SV Ball</i>	<i>Entrance</i>	<i>20</i>	<i>43</i>
<i>CL</i>	<i>Entrance</i>	<i>6</i>	<i>31</i>
<b>Deadbolts</b>			
<i>Item</i>	<i>Function</i>	<i>Case Quantity</i>	<i>Average Weight/Case (lbs.)**</i>
<i>KT Single Cylinder</i>	<i>116</i>	<i>10</i>	<i>19</i>
<i>KT Double Cylinder</i>	<i>137</i>	<i>10</i>	<i>22</i>
<i>KM Single Cylinder</i>	<i>116</i>	<i>20</i>	<i>41</i>
<i>KM Double Cylinder</i>	<i>137</i>	<i>20</i>	<i>54</i>
<i>KV Single Cylinder</i>	<i>116</i>	<i>20</i>	<i>26</i>
<i>KV Double Cylinder</i>	<i>137</i>	<i>20</i>	<i>35</i>
<b>Closers</b>			
<i>Item</i>	<i>Application</i>	<i>Case Quantity</i>	<i>Average Weight/Case (lbs.)**</i>
<i>3100</i>	<i>Tri-Pack</i>	<i>10</i>	<i>61</i>
<i>5100</i>	<i>Tri-Pack</i>	<i>6</i>	<i>48</i>
<i>5300</i>	<i>Tri-Pack</i>	<i>6</i>	<i>41</i>
<i>5500</i>	<i>Tri-Pack</i>	<i>6</i>	<i>41</i>
<i>7100</i>	<i>Tri-Pack</i>	<i>4</i>	<i>50</i>
<b>Exit Devices</b>			
<i>Item</i>	<i>Application</i>	<i>Case Quantity</i>	<i>Average Weight/Case (lbs.)**</i>
<i>4200R 3'</i>	<i>Rim</i>	<i>4</i>	<i>43</i>
<i>4200V 3'</i>	<i>Surface Vertical</i>	<i>4</i>	<i>61</i>
<i>4200RA 4'</i>	<i>Rim</i>	<i>4</i>	<i>45</i>
<i>4200VA 4'</i>	<i>Surface Vertical</i>	<i>4</i>	<i>67</i>
<i>6300R 3'/6320R 2'</i>	<i>Rim</i>	<i>4</i>	<i>60</i>
<i>6310R 4'</i>	<i>Rim</i>	<i>4</i>	<i>68</i>
<i>6300V 3'/6320V 2'</i>	<i>Surface Vertical</i>	<i>4</i>	<i>70</i>
<i>6310V 4'</i>	<i>Surface Vertical</i>	<i>4</i>	<i>78</i>
<i>6300C 3'/6320C 2'</i>	<i>Concealed Vertical</i>	<i>4</i>	<i>68</i>
<i>6310C 4'</i>	<i>Concealed Vertical</i>	<i>4</i>	<i>72</i>
<i>6300M 3'/6320M 2'</i>	<i>Mortise</i>	<i>4</i>	<i>68</i>
<i>6310M 4'</i>	<i>Mortise</i>	<i>4</i>	<i>72</i>
<i>6300D 3'</i>	<i>Dummy</i>	<i>4</i>	<i>44</i>
<i>6310D 4'</i>	<i>Dummy</i>	<i>4</i>	<i>46</i>
<i>6320D 2'</i>	<i>Dummy</i>	<i>4</i>	<i>42</i>
<i>6400R 3'/6420R 2'</i>	<i>Rim</i>	<i>4</i>	<i>58</i>
<i>6410R 4'</i>	<i>Rim</i>	<i>4</i>	<i>68</i>
<i>6400V 3'/6420V 2'</i>	<i>Surface Vertical</i>	<i>4</i>	<i>70</i>
<i>6410V 4'</i>	<i>Surface Vertical</i>	<i>4</i>	<i>74</i>
<i>6400C 3'/6420C 2'</i>	<i>Concealed Vertical</i>	<i>4</i>	<i>68</i>
<i>6410C 4'</i>	<i>Concealed Vertical</i>	<i>4</i>	<i>72</i>

\*Data is with PHL lever unless otherwise noted. \*\*Add approximately 2 lbs. for fire rated device.



# Customer Training Program

Contact [training@pdqlocks.com](mailto:training@pdqlocks.com) to Schedule Your Virtual Training

<b>Course 1: Construction Basics</b>	General introduction to the construction process and how Division 8 fits into the process. There will be information given on the 6 main phases of construction, floor plans, Master Format, specifications, and construction schedules.	<b>Duration: 30-45 mins</b>
<b>Course 2: Hanging the Door</b>	The first concern in door hardware is getting the door upright and swinging. Information about the various ways to hang a door are included in this segment. There will be information on continuous hinges, door pivots, floor closers, specialty hinges, butt hinges, and electrified hinges.	<b>Duration: 30-45 mins</b>
<b>Course 3: Securing the Door</b>	After the door is swinging successfully the door is generally secured via a latch or locking mechanism. This session reviews all the ways to secure a door including not only traditional locks, but also exit devices, and special scenario locking devices.	<b>Duration: 30-45 mins</b>
<b>Course 4: Electrified Options</b>	Various options for electrified openings are reviewed in this session. This will include standard access control options, as well as more complex applications like Delayed Egress.	<b>Duration: 30-45 mins</b>
<b>Course 5: Control the Door</b>	Once the door is hanging and secured it often needs to be controlled. This lesson will include ways that a door is controlled, which can include the various closer types, coordinators, and auto operators. Even items such as floor stops and wall stops can be considered part of controlling the movement of the door.	<b>Duration: 30-45 mins</b>
<b>Course 6: Protecting the Door</b>	Once the door is operating as intended, the last step is to protect the door so it stays looking and operating as new for as long as possible. Items included in this category can include, kick-plates, push pull plates, silencers, and edge guards among many other items.	<b>Duration: 30-45 mins</b>
<b>Course 7: Keying Basics</b>	How a building is keyed can be critical to the proper functioning of the space as the owner intends. In this section we will review the basics for the mechanics of how a lock is keyed, and also gain a general understanding of masterkeying concepts.	<b>Duration: 30-45 mins</b>
<b>Course 8: PDQ Products</b>	This course explores PDQ products, their features, benefits, and applications, offering practical insights into selecting the right hardware to meet specific needs, ensure compliance, and enhance security.	<b>Duration: 60-90 mins</b>

# SECURING CONFIDENCE **OPENING** **POSSIBILITIES**



**Phone:** 717.656.4281  
**Tech Support:** 833.273.7832



**Headquarters:**  
2230 Embassy Drive,  
Lancaster, PA 17603

P.O. Box 6426  
Lancaster, PA 17607



**Email:** [help@pdqlocks.com](mailto:help@pdqlocks.com)



**Regional Distribution Centers:**  
Lancaster, PA | Norcross, GA |  
Auburn, WA