

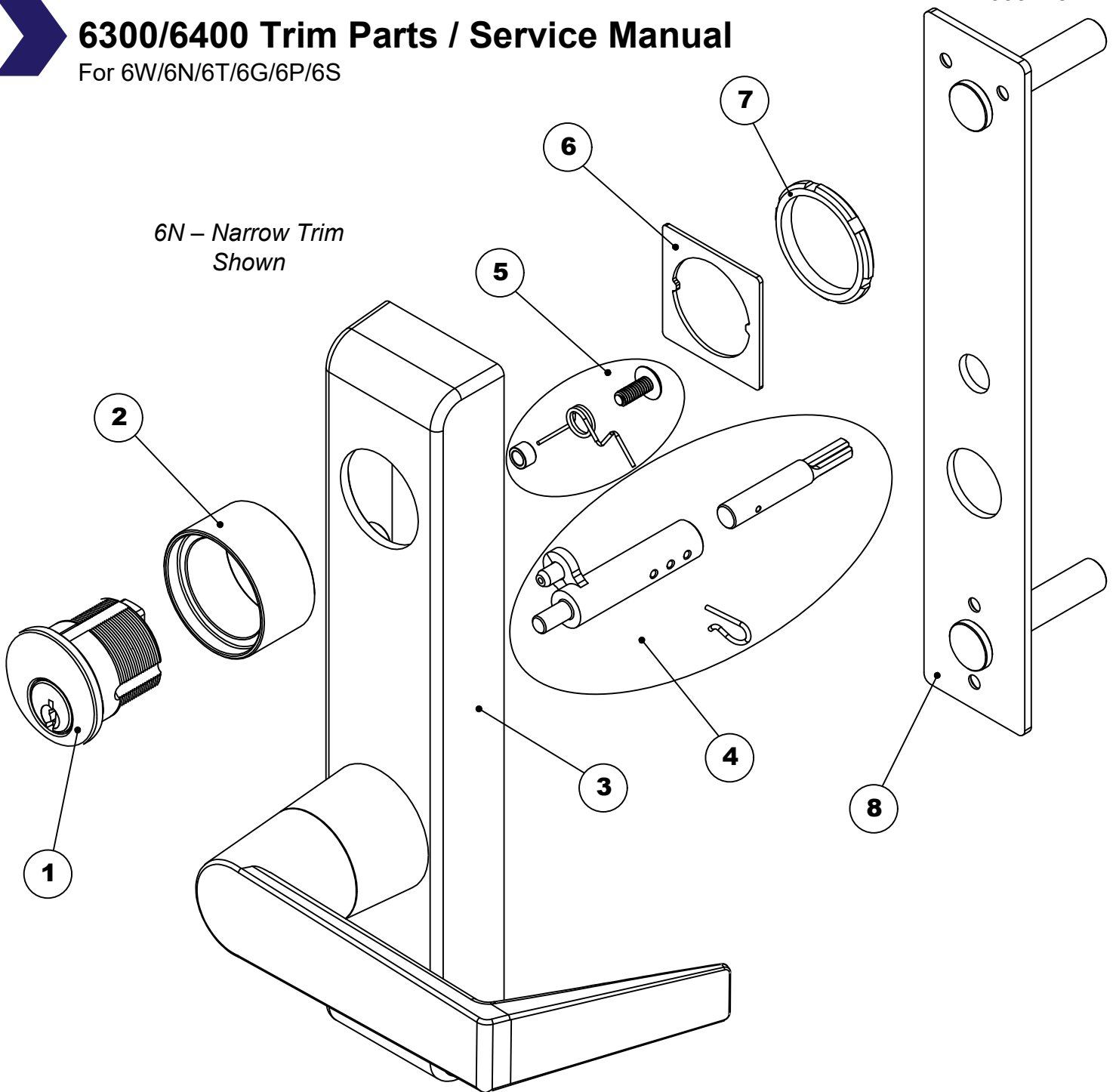

6300/6400 Trim Parts / Service Manual

For 6W/6N/6T/6G/6P/6S

6N – Narrow Trim
Shown



Item No.	Name
1	Cylinder
2	Cylinder Collar
3	Trim Body
4	Drive Spindle
5	Function Kit
6	Cylinder Anti-Rotation Plate
7	Cylinder Retaining Nut
8	Backplate

6300/6400 Trim Spindles, Conversion Kits and Screws

Trim Spindles

Lever Spindle Driver	88652
Mortise Exit Lever Drive Spindle	639729
Driver 1-3/4" - 2-1/4" Door	88678
Driver 2.5" - 3" door	631750
Driver Retainer Clip	88676
Drive Spindle Assembly 1-3/4" - 2-1/4" Door	639072
Drive Spindle Assembly 2-1/2" - 3" Door	639726

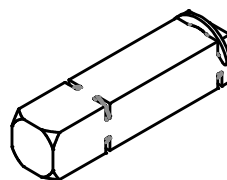

Lever Spindle Driver

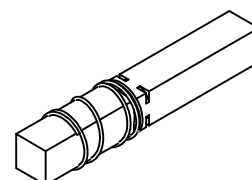
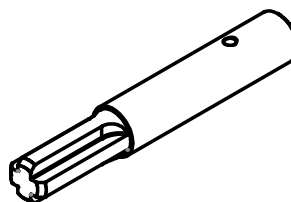
Mortise Exit Lever
Drive Spindle

Driver

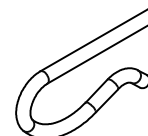

Driver Retainer Clip

Function Conversion Kits

09 to 08 Conversion Kit	639730
08 to 09 Conversion Kit	639731

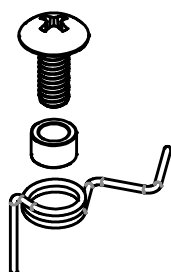
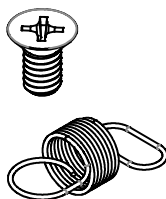
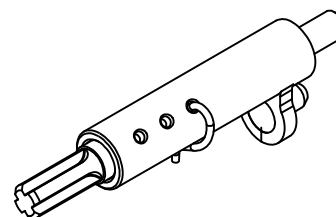
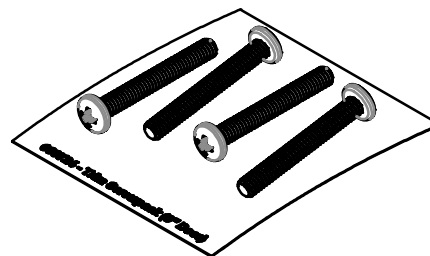
09 to 08
Conversion Kit08 to 09
Conversion KitDrive Spindle
Assembly

Trim Screw Pack

Screw Packs - Not Applicable on 6S

Trim Screw Pack (1-3/4" - 2" Door)	88654
Trim Screw Pack (2-1/2" - 2-3/4" Door)	88672
Trim Screw Pack (3" Door)	639724
Finish Washer and Screw - 6T Specify Finish (1-3/4" - 2" Door)	639725

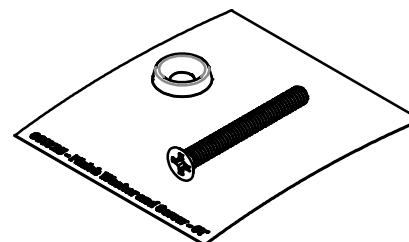
Finish Washer and
Screw - 6T

6300/6400 Trim Cylinder Accessories

Trim Cylinder Accessories

Cylinder Anti-Rotation Plate	88608
Cylinder Retaining Nut	88644
Cylinder Nut Tool	88875
Cylinder Cup	631606

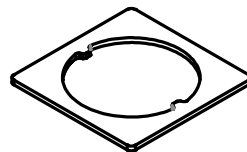

Cylinder Anti-Rotation Plate

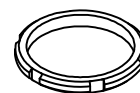

Cylinder Retaining Nut



Cylinder Cup

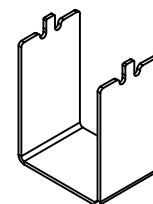

Cylinder Nut Tool

Cylinder Collars - Specify Finish

Tall Trim Ring / Spacer Reversible 5/8" Collar or 3/4" Spacer	631094-XXX
Short Trim Ring / Spacer Reversible No Height Collar or 1/4" Spacer	631093-XXX

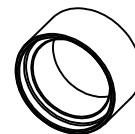

Cylinder Collars

Cylinder Application Chart

Type	Function	Image	Standard Cyl	Best SFIC	Schlage LFIC
6W	All Keyed Functions		1-1/8" Mortise Cylinder 631094 Collar (5/8")	SFIC 7 pin housing 631094 Collar Flipped (3/4") 631093 Trim Ring	LFIC housing 631094 Collar Flipped (3/4") 631093 Trim Ring
6N	08, 09		1-1/8" Mortise Cylinder 631094 Collar (5/8")	SFIC 7 pin housing 631094 Collar Flipped (3/4") 631093 Trim Ring	LFIC housing 631094 Collar Flipped (3/4") 631093 Trim Ring
6N	03		Rim Cylinder	SFIC rim housing	LFIC rim housing
6S	All Keyed Functions		Must order product with KIK / Standard cylinder lever	Must order product with SFIC lever	Must order product with Schlage style LFIC Lever
6T	All Keyed Functions		1-1/8" Mortise Cylinder 631094 Collar (5/8")	SFIC 7 pin housing 631094 Collar Flipped (3/4") 631093 Trim Ring	LFIC housing 631094 Collar Flipped (3/4") 631093 Trim Ring
6G	All Keyed Functions		Rim Cylinder Standard rim cylinder trim ring	SFIC rim housing Standard rim cylinder trim ring	LFIC rim housing Standard rim cylinder trim ring
6P	All Keyed Functions		Rim Cylinder Standard rim cylinder trim ring	SFIC rim housing Standard rim cylinder trim ring	LFIC rim housing Standard rim cylinder trim ring